

International IR Rectifier

- Logic-Level Gate Drive
- Advanced Process Technology
- Ultra Low On-Resistance
- Dynamic dv/dt Rating
- 175°C Operating Temperature
- Fast Switching
- Fully Avalanche Rated
- Lead-Free

Description

Fifth Generation HEXFET® power MOSFETs from International Rectifier utilize advanced processing techniques to achieve extremely low on-resistance per silicon area. This benefit, combined with the fast switching speed and ruggedized device design that HEXFET power MOSFETs are well known for, provides the designer with an extremely efficient and reliable device for use in a wide variety of applications.

The D²Pak is a surface mount power package capable of accommodating die sizes up to HEX-4. It provides the highest power capability and the lowest possible on-resistance in any existing surface mount package. The D²Pak is suitable for high current applications because of its low internal connection resistance and can dissipate up to 2.0W in a typical surface mount application.

The through-hole version (IRL1004L) is available for low-profile application.

Absolute Maximum Ratings

| | Parameter | Max. | Units |
|---------------------------------|---|-----------------------|-------|
| $I_D @ T_C = 25^\circ\text{C}$ | Continuous Drain Current, $V_{GS} @ 10\text{V} \textcircled{6}$ | 130 $\textcircled{5}$ | A |
| $I_D @ T_C = 100^\circ\text{C}$ | Continuous Drain Current, $V_{GS} @ 10\text{V} \textcircled{6}$ | 92 $\textcircled{5}$ | |
| I_{DM} | Pulsed Drain Current $\textcircled{1} \textcircled{6}$ | 520 | |
| $P_D @ T_A = 25^\circ\text{C}$ | Power Dissipation | 3.8 | W |
| $P_D @ T_C = 25^\circ\text{C}$ | Power Dissipation | 200 | W |
| | Linear Derating Factor | 1.3 | W/°C |
| V_{GS} | Gate-to-Source Voltage | ± 16 | V |
| E_{AS} | Single Pulse Avalanche Energy $\textcircled{6}$ | 700 | mJ |
| I_{AR} | Avalanche Current $\textcircled{1}$ | 78 | A |
| E_{AR} | Repetitive Avalanche Energy $\textcircled{1}$ | 20 | mJ |
| dv/dt | Peak Diode Recovery dv/dt $\textcircled{3} \textcircled{6}$ | 5.0 | V/ns |
| T_J | Operating Junction and | -55 to + 175 | °C |
| T_{STG} | Storage Temperature Range | | |
| | Soldering Temperature, for 10 seconds | 300 (1.6mm from case) | |

Thermal Resistance

| | Parameter | Typ. | Max. | Units |
|-----------------|---|------|------|-------|
| $R_{\theta JC}$ | Junction-to-Case | — | 0.75 | °C/W |
| $R_{\theta JA}$ | Junction-to-Ambient (PCB Mounted, steady-state)* | — | 40 | |

www.irf.com

1

PD - 95575

IRL1004SPbF

IRL1004LPbF

HEXFET® Power MOSFET

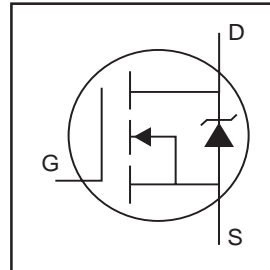

$V_{DSS} = 40\text{V}$
 $R_{DS(on)} = 0.0065\Omega$
 $I_D = 130\text{A} \textcircled{5}$

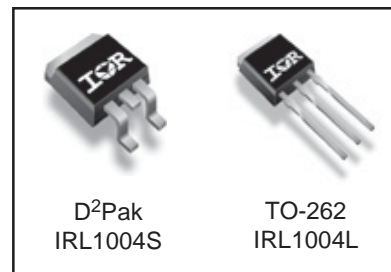

D²Pak
IRL1004S

TO-262
IRL1004L

Electrical Characteristics @ T_J = 25°C (unless otherwise specified)

| | Parameter | Min. | Typ. | Max. | Units | Conditions |
|--|--------------------------------------|------|------|--------|-------|---|
| V _{(BR)DSS} | Drain-to-Source Breakdown Voltage | 40 | — | — | V | V _{GS} = 0V, I _D = 250μA |
| ΔV _{(BR)DSS} /ΔT _J | Breakdown Voltage Temp. Coefficient | — | 0.04 | — | V/°C | Reference to 25°C, I _D = 1mA |
| R _{DS(on)} | Static Drain-to-Source On-Resistance | — | — | 0.0065 | Ω | V _{GS} = 10V, I _D = 78A ④ |
| | | — | — | 0.009 | | V _{GS} = 4.5V, I _D = 65A ④ |
| V _{GS(th)} | Gate Threshold Voltage | 1.0 | — | — | V | V _{DS} = V _{GS} , I _D = 250μA |
| g _{fs} | Forward Transconductance | 63 | — | — | S | V _{DS} = 25V, I _D = 78A⑥ |
| I _{DSS} | Drain-to-Source Leakage Current | — | — | 25 | μA | V _{DS} = 40V, V _{GS} = 0V |
| | | — | — | 250 | | V _{DS} = 32V, V _{GS} = 0V, T _J = 150°C |
| I _{GSS} | Gate-to-Source Forward Leakage | — | — | 100 | nA | V _{GS} = 16V |
| | Gate-to-Source Reverse Leakage | — | — | -100 | | V _{GS} = -16V |
| Q _g | Total Gate Charge | — | — | 100 | nC | I _D = 78A |
| Q _{gs} | Gate-to-Source Charge | — | — | 32 | | V _{DS} = 32V |
| Q _{gd} | Gate-to-Drain ("Miller") Charge | — | — | 43 | | V _{GS} = 4.5V, See Fig. 6 and 13 ④⑥ |
| t _{d(on)} | Turn-On Delay Time | — | 16 | — | | V _{DD} = 20V, |
| t _r | Rise Time | — | 210 | — | ns | I _D = 78A, |
| t _{d(off)} | Turn-Off Delay Time | — | 25 | — | | R _G = 2.5Ω, |
| t _f | Fall Time | — | 14 | — | | R _D = 0.18Ω, See Fig. 10 ④⑥ |
| L _S | Internal Source Inductance | — | 7.5 | — | nH | Between lead, and center of die contact |
| C _{iss} | Input Capacitance | — | 5330 | — | pF | V _{GS} = 0V |
| C _{oss} | Output Capacitance | — | 1480 | — | | V _{DS} = 25V |
| C _{rss} | Reverse Transfer Capacitance | — | 320 | — | | f = 1.0MHz, See Fig. 5④⑥ |

Source-Drain Ratings and Characteristics

| | Parameter | Min. | Typ. | Max. | Units | Conditions |
|-----------------|--|--|------|------|-------|---|
| I _S | Continuous Source Current (Body Diode)② | — | — | 130⑤ | A | MOSFET symbol showing the integral reverse p-n junction diode. |
| I _{SM} | Pulsed Source Current (Body Diode) ①② | — | — | 520 | | |
| V _{SD} | Diode Forward Voltage | — | — | 1.3 | V | T _J = 25°C, I _S = 78A, V _{GS} = 0V④ |
| t _{rr} | Reverse Recovery Time | — | 78 | 120 | ns | T _J = 25°C, I _F = 78A |
| Q _{rr} | Reverse Recovery Charge | — | 180 | 270 | nC | di/dt = 100A/μs④⑥ |
| t _{on} | Forward Turn-On Time | Intrinsic turn-on time is negligible (turn-on is dominated by L _S +L _D) | | | | |

Notes:

- ① Repetitive rating; pulse width limited by max. junction temperature. (See fig. 11)
- ② Starting T_J = 25°C, L = 0.23mH
R_G = 25Ω, I_{AS} = 78A. (See Figure 12)
- ③ I_{SD} ≤ 78A, di/dt ≤ 370A/μs, V_{DD} ≤ V_{(BR)DSS},
T_J ≤ 175°C
- ④ Pulse width ≤ 300μs; duty cycle ≤ 2%.
- ⑤ Calculated continuous current based on maximum allowable junction temperature; for recommended current-handling of the package refer to Design Tip # 93-4
- ⑥ Uses IRL1004 data and test conditions

* When mounted on 1" square PCB (FR-4 or G-10 Material).
For recommended footprint and soldering techniques refer to application note #AN-994.

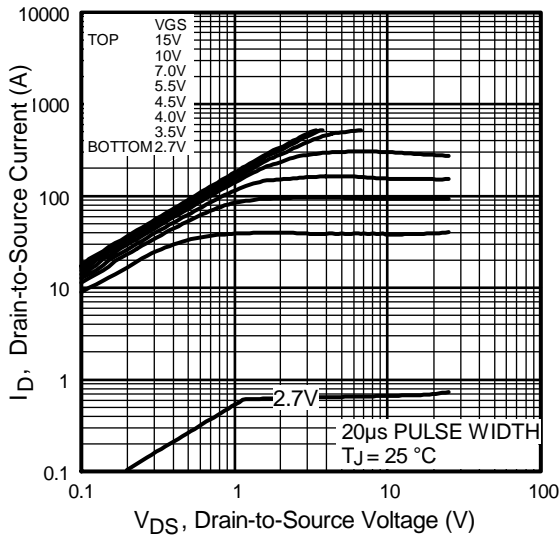

Fig 1. Typical Output Characteristics

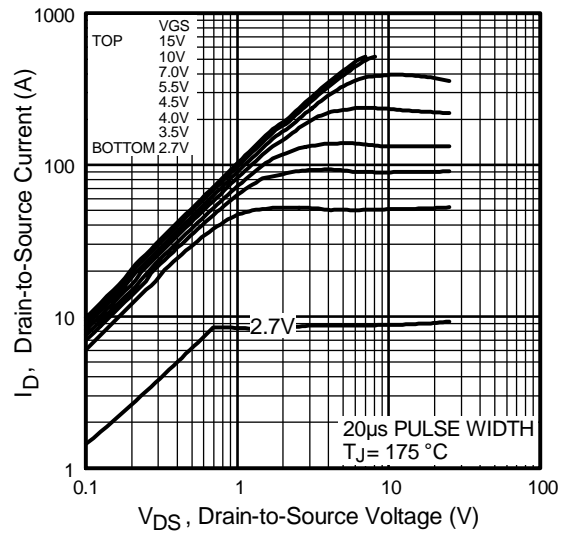

Fig 2. Typical Output Characteristics

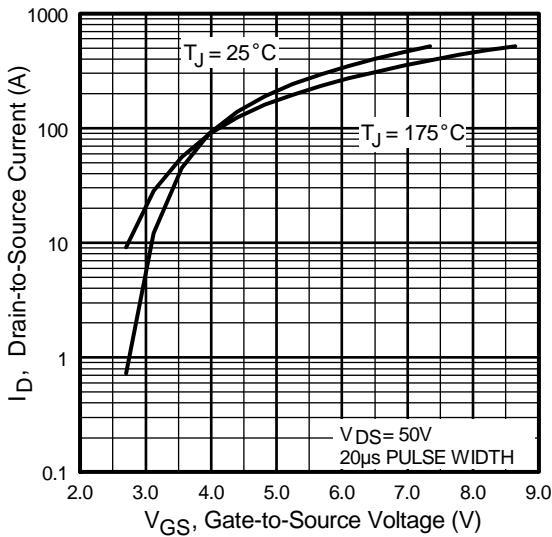

Fig 3. Typical Transfer Characteristics

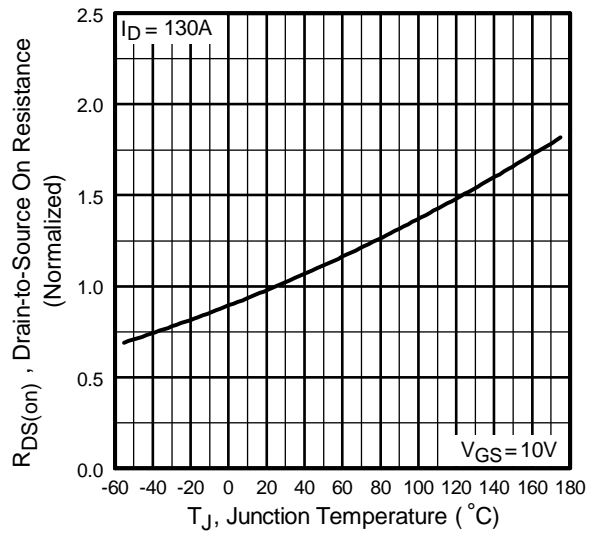

Fig 4. Normalized On-Resistance Vs. Temperature

IRL1004S/LPbF

International
IR Rectifier

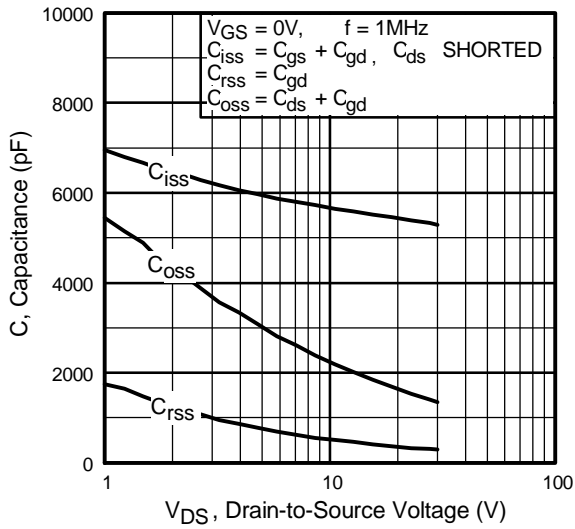

Fig 5. Typical Capacitance Vs. Drain-to-Source Voltage

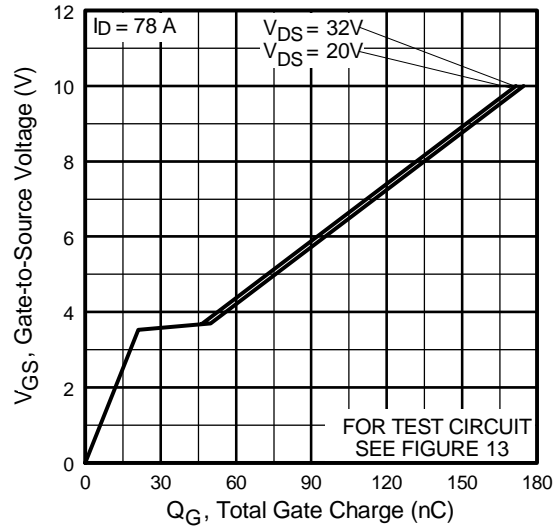

Fig 6. Typical Gate Charge Vs. Gate-to-Source Voltage

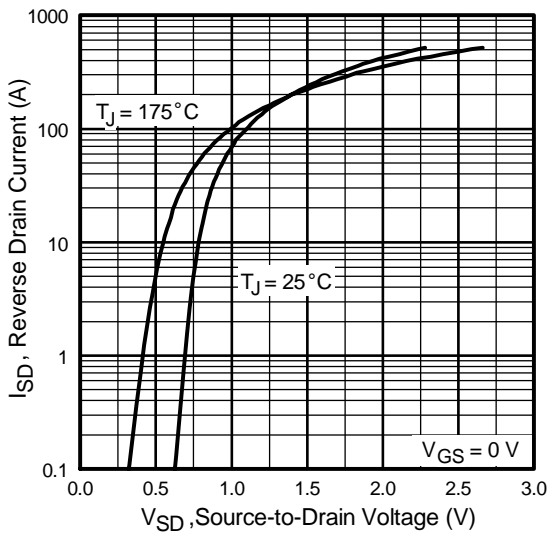

Fig 7. Typical Source-Drain Diode Forward Voltage

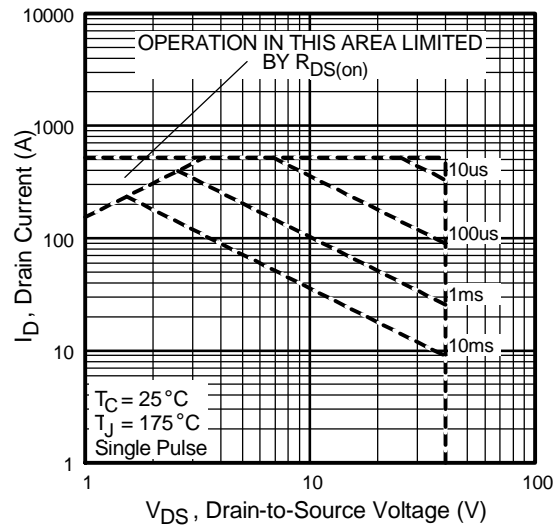

Fig 8. Maximum Safe Operating Area

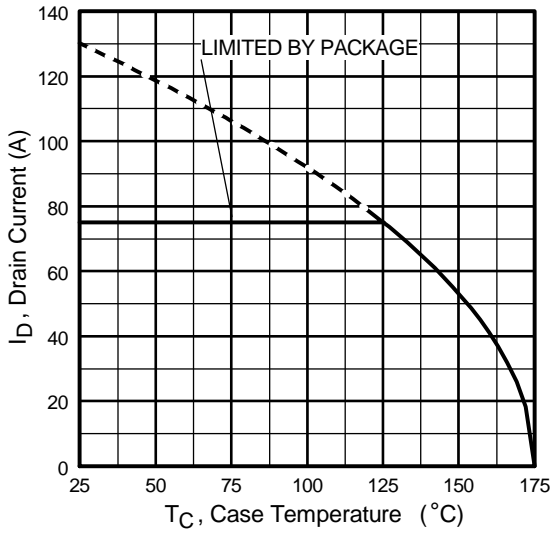

Fig 9. Maximum Drain Current Vs. Case Temperature

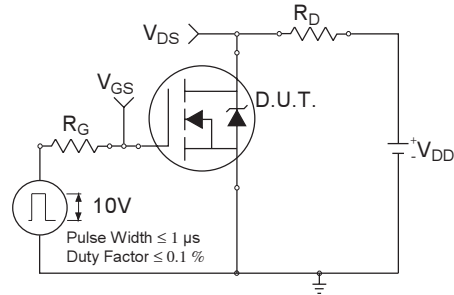

Fig 10a. Switching Time Test Circuit

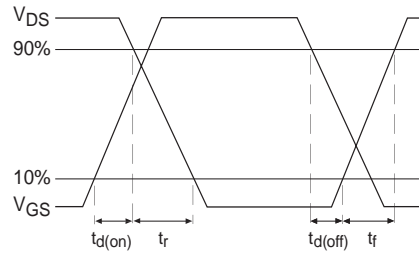

Fig 10b. Switching Time Waveforms

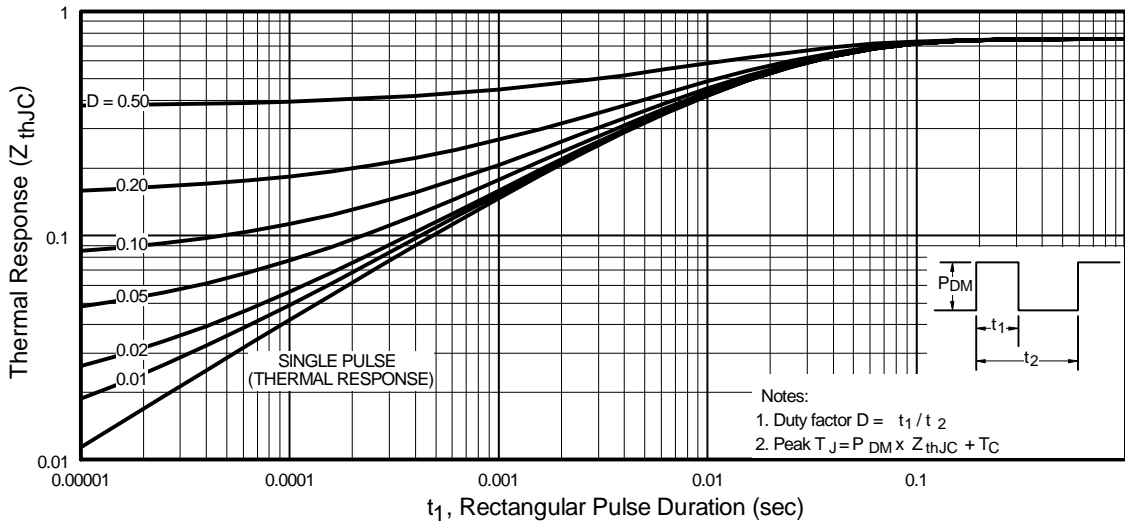

Fig 11. Maximum Effective Transient Thermal Impedance, Junction-to-Case

IRL1004S/LPbF

International
IRF Rectifier

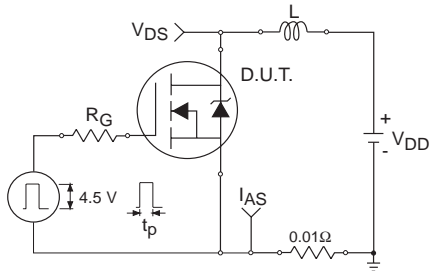

Fig 12a. Unclamped Inductive Test Circuit

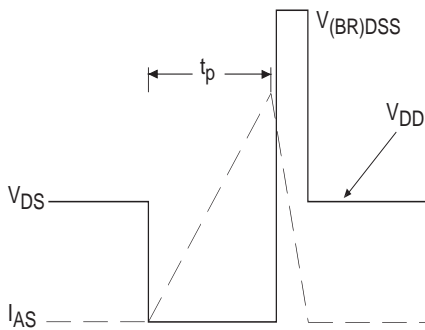

Fig 12b. Unclamped Inductive Waveforms

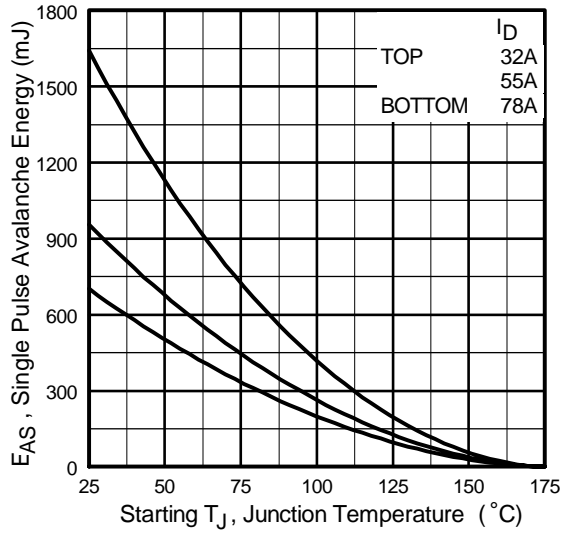

Fig 12c. Maximum Avalanche Energy Vs. Drain Current

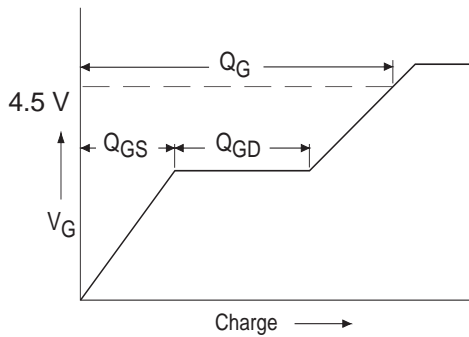

Fig 13a. Basic Gate Charge Waveform

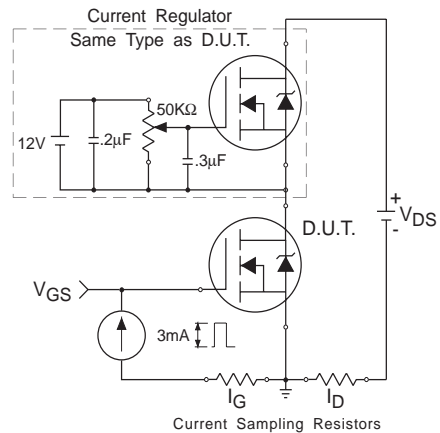
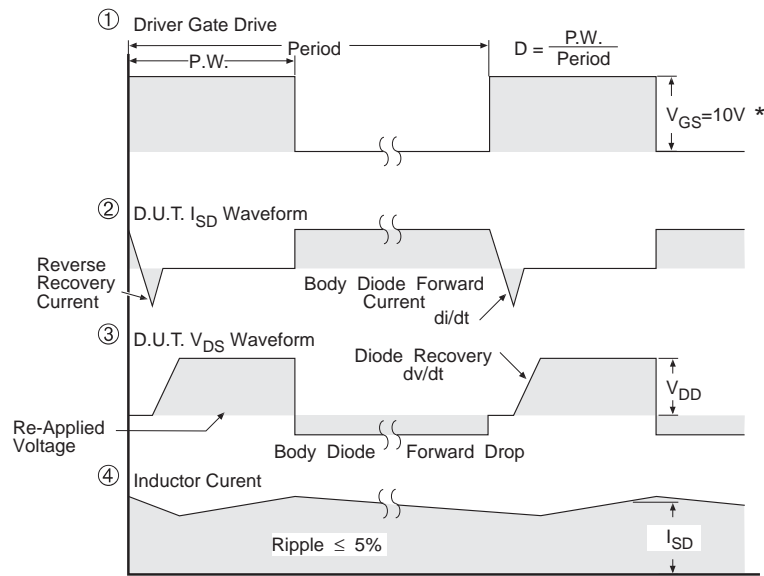
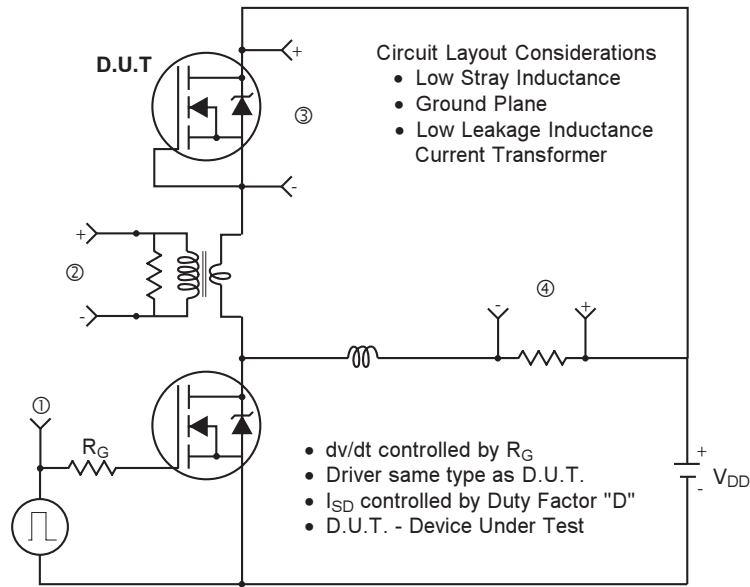

Fig 13b. Gate Charge Test Circuit

Peak Diode Recovery dv/dt Test Circuit



* $V_{GS} = 5V$ for Logic Level Devices

Fig 14. For N-channel HEXFET® Power MOSFETs

TO-262 Package Outline

Dimensions are shown in millimeters (inches)

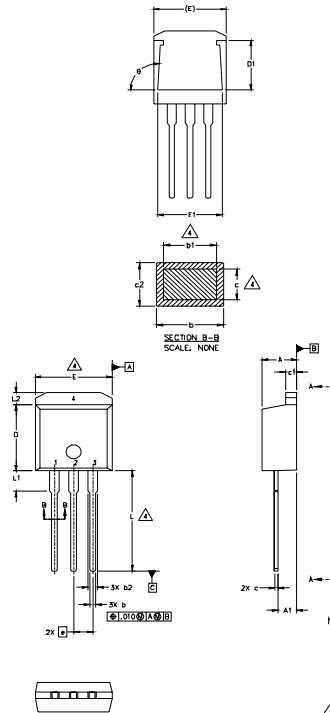

| SYMBOL | DIMENSIONS | | | | NOTES |
|--------|-------------|-------|--------|------|-------|
| | MILLIMETERS | | INCHES | | |
| | MIN. | MAX. | MIN. | MAX. | |
| A | 4.06 | 4.83 | .160 | .190 | 4 |
| A1 | 2.03 | 2.92 | .080 | .115 | |
| b | 0.51 | 0.99 | .020 | .039 | |
| b1 | 0.51 | 0.89 | .020 | .035 | |
| b2 | 1.14 | 1.40 | .045 | .055 | 4 |
| c | 0.38 | 0.63 | .015 | .025 | |
| c1 | 1.14 | 1.40 | .045 | .055 | 3 |
| c2 | 0.43 | .063 | .017 | .029 | |
| D | 8.51 | 9.65 | .335 | .380 | |
| D1 | 5.33 | | .210 | | 3 |
| E | 9.65 | 10.67 | .380 | .420 | |
| E1 | 6.22 | | .245 | | |
| e | 2.54 | BSC | .100 | BSC | |
| L | 13.46 | 14.09 | .530 | .555 | |
| L1 | 3.56 | 3.71 | .140 | .146 | |
| L2 | | 1.65 | | .065 | |

LEAD ASSIGNMENTS

| HEXFET | IGBT |
|------------|---------------|
| 1.- GATE | 1 - GATE |
| 2.- DRAIN | 2 - COLLECTOR |
| 3.- SOURCE | 3 - EMITTER |
| 4.- DRAIN | |

- NOTES:
1. DIMENSIONING AND TOLERANCING PER ASME Y14.5M-1994
 2. DIMENSIONS ARE SHOWN IN MILLIMETERS [INCHES].
 3. DIMENSION D & E DO NOT INCLUDE MOLD FLASH. MOLD FLASH SHALL NOT EXCEED 0.127 [0.005"] PER SIDE. THESE DIMENSIONS ARE MEASURED AT THE OUTMOST EXTREMES OF THE PLASTIC BODY.
 4. DIMENSION b1 AND c1 APPLY TO BASE METAL ONLY.
 5. CONTROLLING DIMENSION: INCH.

TO-262 Part Marking Information

EXAMPLE: THIS IS AN IRL3103L
LOT CODE 1789
ASSEMBLED ON WW 19, 1997
IN THE ASSEMBLY LINE "C"

Note: "P" in assembly line position indicates "Lead-Free"

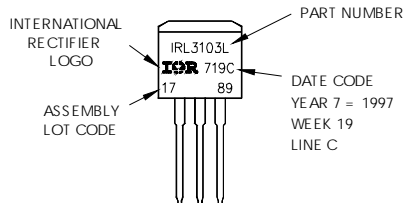

OR

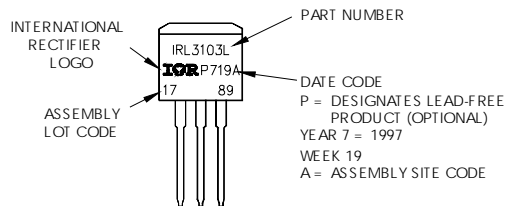

IRL1004S/LPbF

International
IR Rectifier

D²Pak Tape & Reel Information

Dimensions are shown in millimeters (inches)

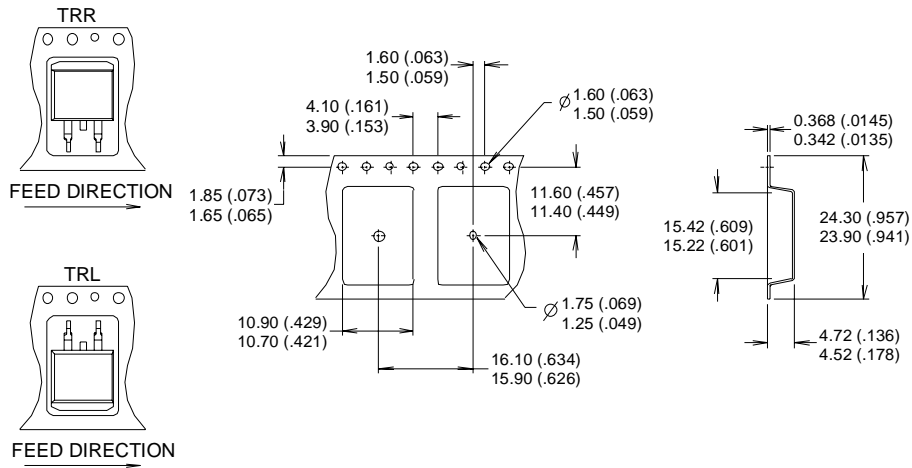

- NOTES :
1. CONFORMS TO EIA-418.
 2. CONTROLLING DIMENSION: MILLIMETER.
 - ③ DIMENSION MEASURED @ HUB.
 - ④ INCLUDES FLANGE DISTORTION @ OUTER EDGE.

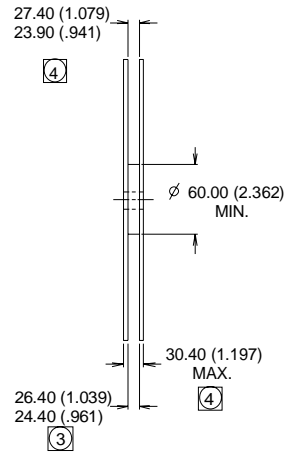

Data and specifications subject to change without notice.

International
IR Rectifier

IR WORLD HEADQUARTERS: 233 Kansas St., El Segundo, California 90245, USA Tel: (310) 252-7105

TAC Fax: (310) 252-7903

Visit us at www.irf.com for sales contact information. 07/04

Note: For the most current drawings please refer to the IR website at:
<http://www.irf.com/package/>