

# IRFH7914PbF

HEXFET® Power MOSFET

## Applications

- Control MOSFET of Sync-Buck Converters used for Notebook Processor Power
- Control MOSFET for Isolated DC-DC Converters in Networking Systems

$V_{DSS}$	$R_{DS(on)}$ max	$Q_g$
30V	8.7m $\Omega$ @ $V_{GS} = 10V$	8.3nC

## Benefits

- Very low  $R_{DS(ON)}$  at 4.5V  $V_{GS}$
- Low Gate Charge
- Fully Characterized Avalanche Voltage and Current
- 100% Tested for  $R_G$
- Lead-Free (Qualified up to 260°C Reflow)
- RoHS compliant (Halogen Free)
- Low Thermal Resistance
- Large Source Lead for more reliable Soldering

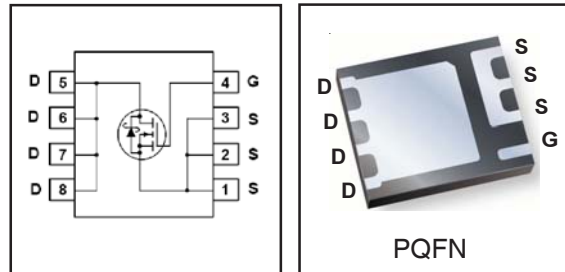

## Absolute Maximum Ratings

	Parameter	Max.	Units
$V_{DS}$	Drain-to-Source Voltage	30	V
$V_{GS}$	Gate-to-Source Voltage	$\pm 20$	
$I_D @ T_A = 25^\circ C$	Continuous Drain Current, $V_{GS} @ 10V$	15	A
$I_D @ T_A = 70^\circ C$	Continuous Drain Current, $V_{GS} @ 10V$	12	
$I_D @ T_C = 25^\circ C$	Continuous Drain Current, $V_{GS} @ 10V$	35	
$I_{DM}$	Pulsed Drain Current ①	110	
$P_D @ T_A = 25^\circ C$	Power Dissipation ⑤	3.1	W
$P_D @ T_A = 70^\circ C$	Power Dissipation ⑤	2.0	
	Linear Derating Factor ⑤	0.025	W/ $^\circ C$
$T_J$	Operating Junction and	-55 to + 150	$^\circ C$
$T_{STG}$	Storage Temperature Range		

## Thermal Resistance

	Parameter	Typ.	Max.	Units
$R_{\theta JC}$	Junction-to-Case ④	—	7.2	$^\circ C/W$
$R_{\theta JA}$	Junction-to-Ambient ⑤	—	40	

Notes ① through ⑤ are on page 9

www.irf.com

1  
07/15/08

# IRFH7914PbF

Static @  $T_J = 25^\circ\text{C}$  (unless otherwise specified)

International  
IR Rectifier

	Parameter	Min.	Typ.	Max.	Units	Conditions
$BV_{DSS}$	Drain-to-Source Breakdown Voltage	30	—	—	V	$V_{GS} = 0V, I_D = 250\mu A$
$\Delta BV_{DSS}/\Delta T_J$	Breakdown Voltage Temp. Coefficient	—	0.022	—	$V/^\circ C$	Reference to $25^\circ C, I_D = 1mA$
$R_{DS(on)}$	Static Drain-to-Source On-Resistance	—	7.5	8.7	m $\Omega$	$V_{GS} = 10V, I_D = 14A$ ③
		—	11.2	13		$V_{GS} = 4.5V, I_D = 11A$ ③
$V_{GS(th)}$	Gate Threshold Voltage	1.35	1.8	2.35	V	$V_{DS} = V_{GS}, I_D = 25\mu A$
$\Delta V_{GS(th)}$	Gate Threshold Voltage Coefficient	—	-6.08	—	$mV/^\circ C$	
$I_{DSS}$	Drain-to-Source Leakage Current	—	—	1.0	$\mu A$	$V_{DS} = 24V, V_{GS} = 0V$
		—	—	150		$V_{DS} = 24V, V_{GS} = 0V, T_J = 125^\circ C$
$I_{GSS}$	Gate-to-Source Forward Leakage	—	—	100	nA	$V_{GS} = 20V$
	Gate-to-Source Reverse Leakage	—	—	-100		$V_{GS} = -20V$
$g_{fs}$	Forward Transconductance	77	—	—	S	$V_{DS} = 15V, I_D = 11A$
$Q_g$	Total Gate Charge	—	8.3	12	nC	$V_{DS} = 15V$ $V_{GS} = 4.5V$ $I_D = 11A$ See Fig.17 & 18
$Q_{gs1}$	Pre-Vth Gate-to-Source Charge	—	2.1	—		
$Q_{gs2}$	Post-Vth Gate-to-Source Charge	—	1.0	—		
$Q_{gd}$	Gate-to-Drain Charge	—	2.8	—		
$Q_{godr}$	Gate Charge Overdrive	—	2.4	—		
$Q_{sw}$	Switch Charge ( $Q_{gs2} + Q_{gd}$ )	—	3.8	—		
$Q_{oss}$	Output Charge	—	4.8	—	nC	$V_{DS} = 16V, V_{GS} = 0V$
$R_G$	Gate Resistance	—	1.3	2.2	$\Omega$	
$t_{d(on)}$	Turn-On Delay Time	—	11	—	ns	$V_{DD} = 15V, V_{GS} = 4.5V$ $I_D = 11A$ $R_G = 1.8\Omega$ See Fig.15
$t_r$	Rise Time	—	11	—		
$t_{d(off)}$	Turn-Off Delay Time	—	12	—		
$t_f$	Fall Time	—	4.6	—		
$C_{iss}$	Input Capacitance	—	1160	—	pF	$V_{GS} = 0V$ $V_{DS} = 15V$ $f = 1.0MHz$
$C_{oss}$	Output Capacitance	—	220	—		
$C_{rss}$	Reverse Transfer Capacitance	—	100	—		

## Avalanche Characteristics

	Parameter	Typ.	Max.	Units
$E_{AS}$	Single Pulse Avalanche Energy ②	—	17	mJ
$I_{AR}$	Avalanche Current ①	—	11	A

## Diode Characteristics

	Parameter	Min.	Typ.	Max.	Units	Conditions
$I_S$	Continuous Source Current (Body Diode)	—	—	3.9	A	MOSFET symbol showing the integral reverse p-n junction diode.
$I_{SM}$	Pulsed Source Current (Body Diode) ①	—	—	110		
$V_{SD}$	Diode Forward Voltage	—	—	1.0	V	$T_J = 25^\circ C, I_S = 11A, V_{GS} = 0V$ ③
$t_{rr}$	Reverse Recovery Time	—	14	21	ns	$T_J = 25^\circ C, I_F = 11A, V_{DD} = 15V$
$Q_{rr}$	Reverse Recovery Charge	—	9.5	14	nC	$di/dt = 200A/\mu s$ ③
$t_{on}$	Forward Turn-On Time	Intrinsic turn-on time is negligible (turn-on is dominated by LS+LD)				

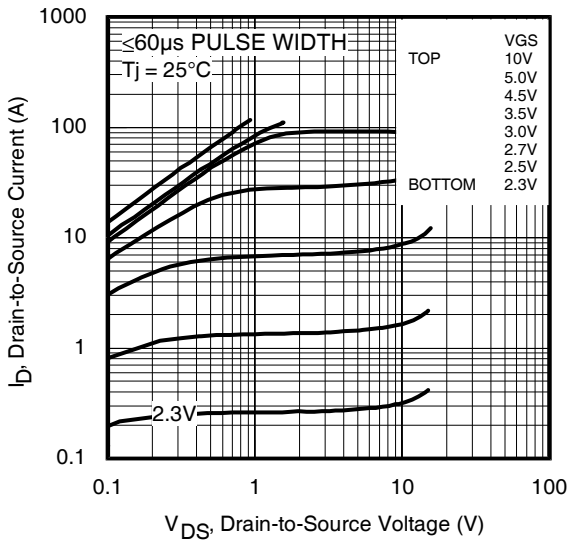

**Fig 1.** Typical Output Characteristics

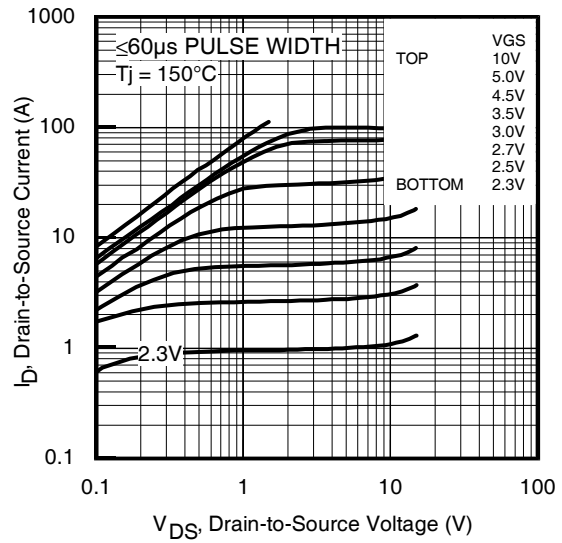

**Fig 2.** Typical Output Characteristics

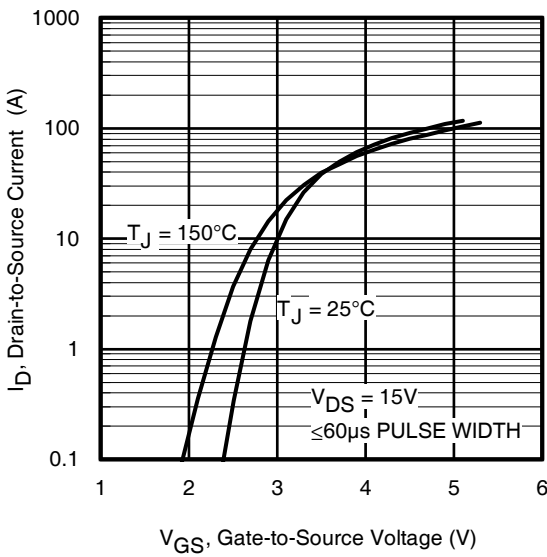

**Fig 3.** Typical Transfer Characteristics

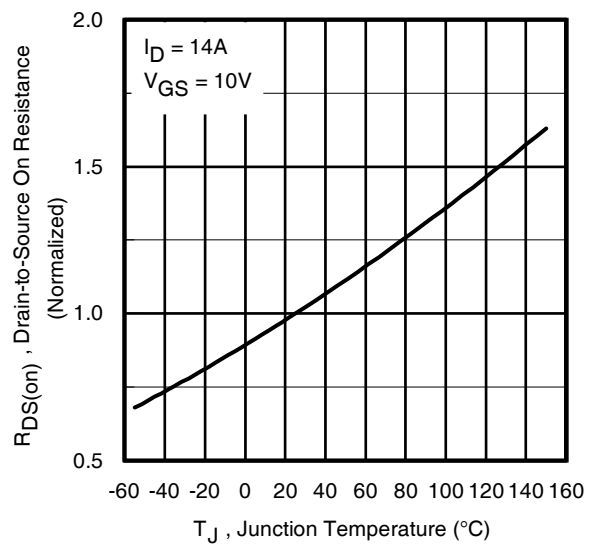

**Fig 4.** Normalized On-Resistance vs. Temperature

# IRFH7914PbF

International  
**IR** Rectifier

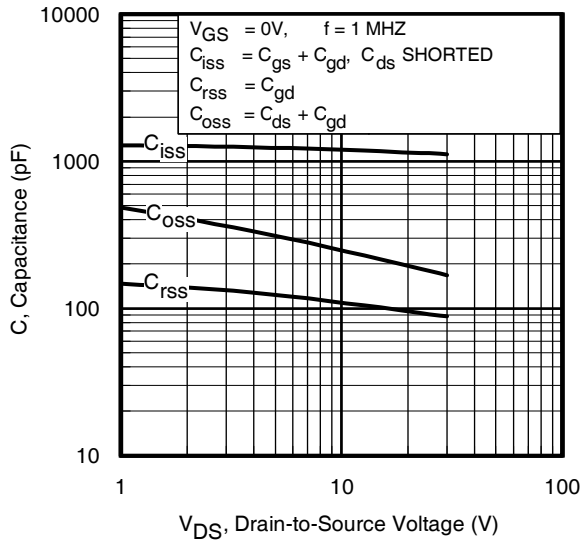

**Fig 5.** Typical Capacitance vs. Drain-to-Source Voltage

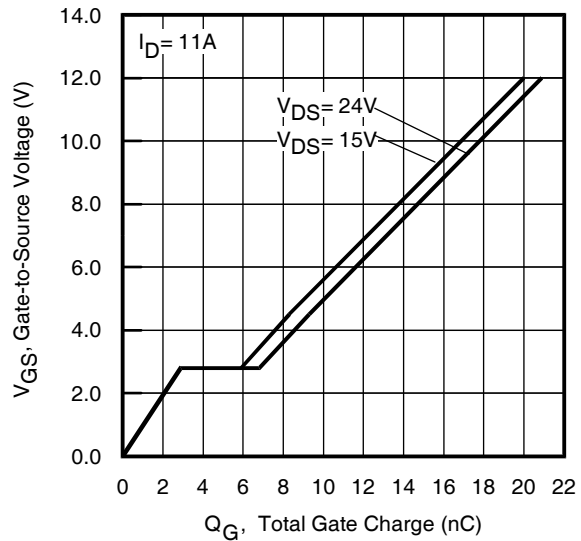

**Fig 6.** Typical Gate Charge vs. Gate-to-Source Voltage

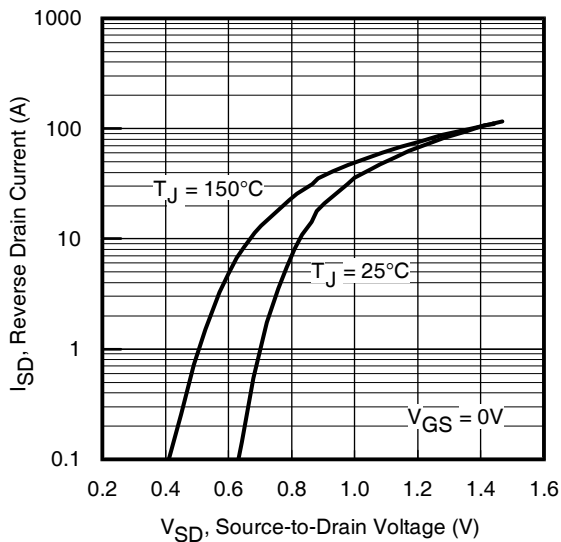

**Fig 7.** Typical Source-Drain Diode Forward Voltage

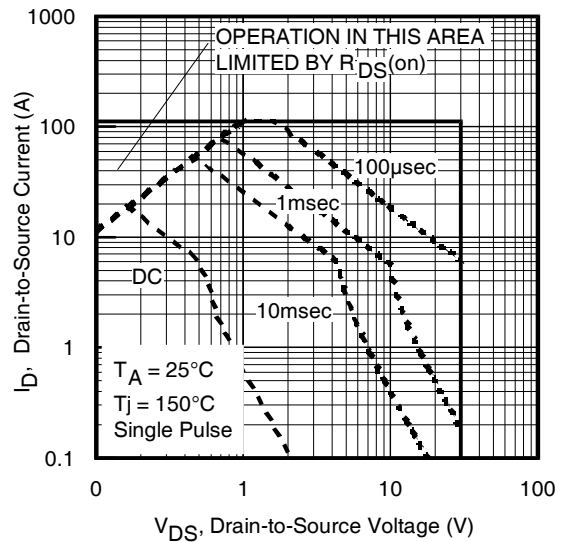

**Fig 8.** Maximum Safe Operating Area

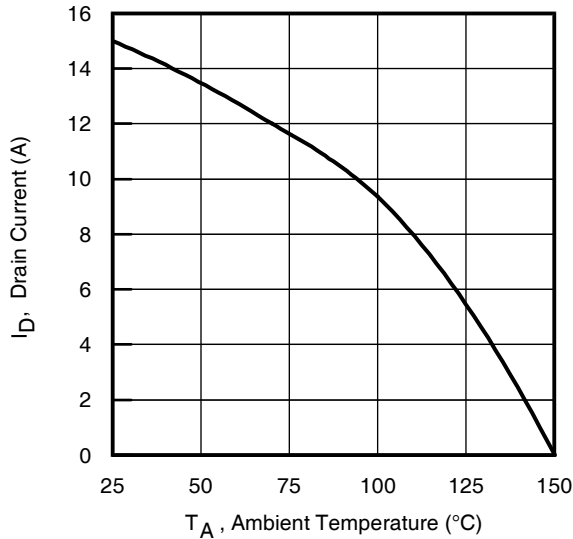

**Fig 9.** Maximum Drain Current vs. Ambient Temperature

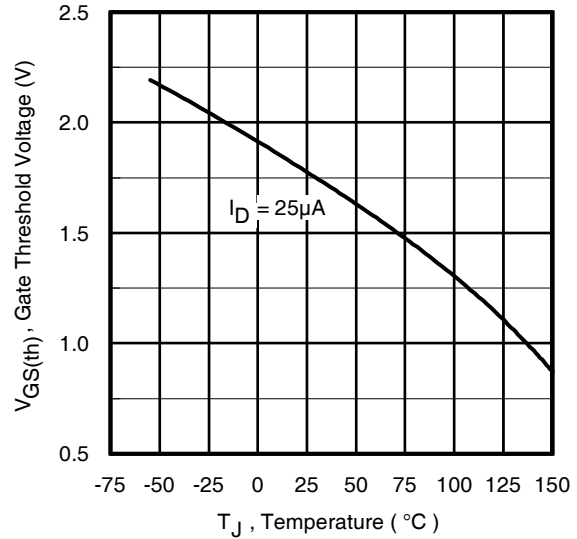

**Fig 10.** Threshold Voltage vs. Temperature

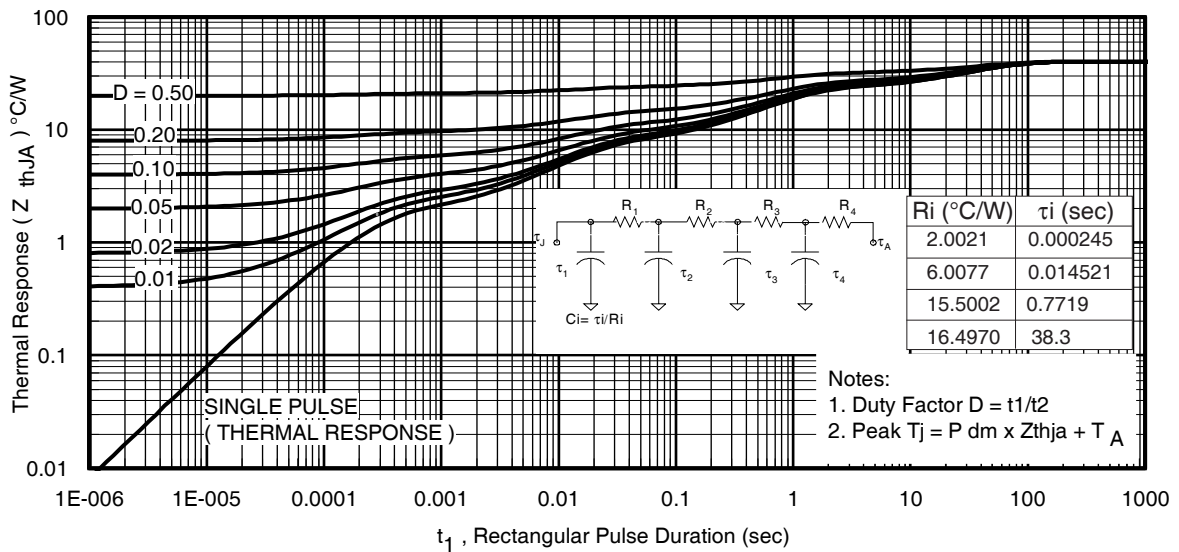

**Fig 11.** Maximum Effective Transient Thermal Impedance, Junction-to-Ambient

# IRFH7914PbF

International  
**IR** Rectifier

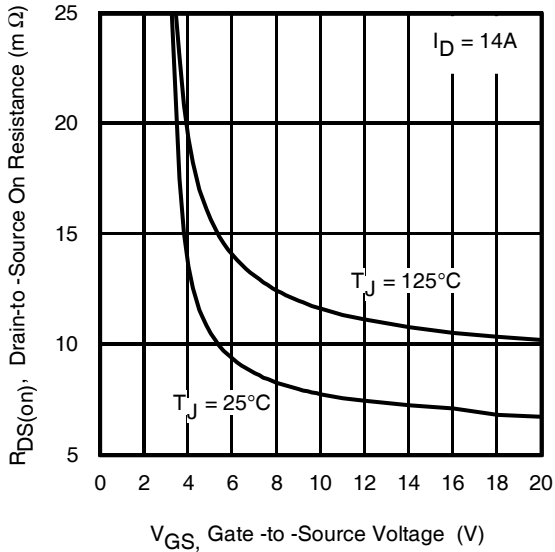

**Fig 12.** On-Resistance vs. Gate Voltage

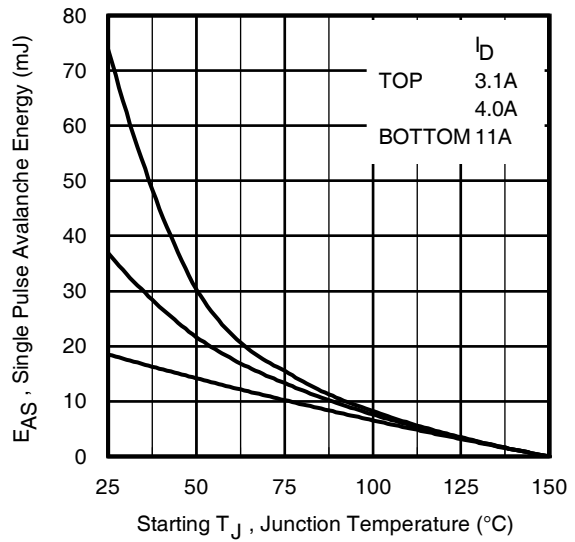

**Fig 13.** Maximum Avalanche Energy vs. Drain Current

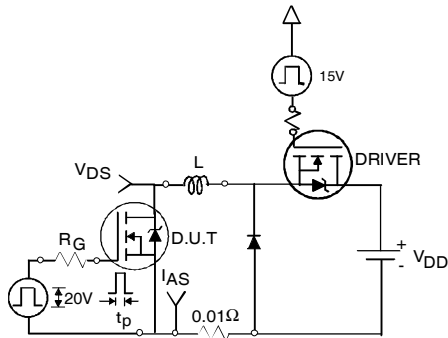

**Fig 14a.** Unclamped Inductive Test Circuit

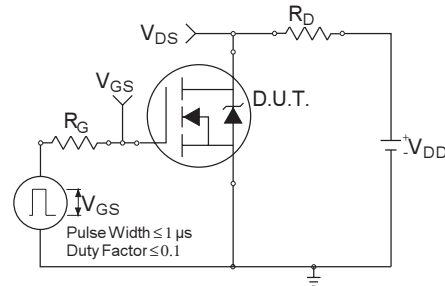

**Fig 15a.** Switching Time Test Circuit

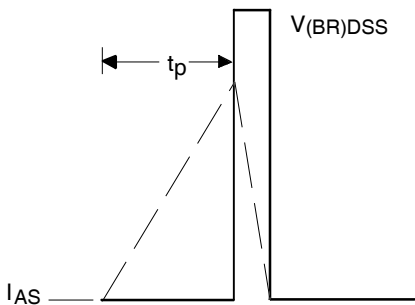

**Fig 14b.** Unclamped Inductive Waveforms

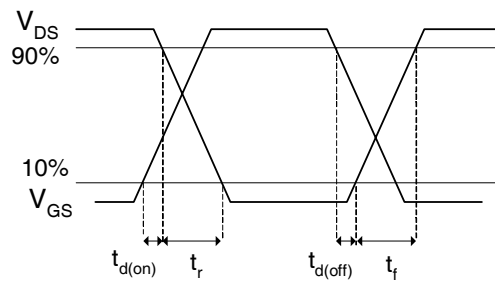

**Fig 15b.** Switching Time Waveforms

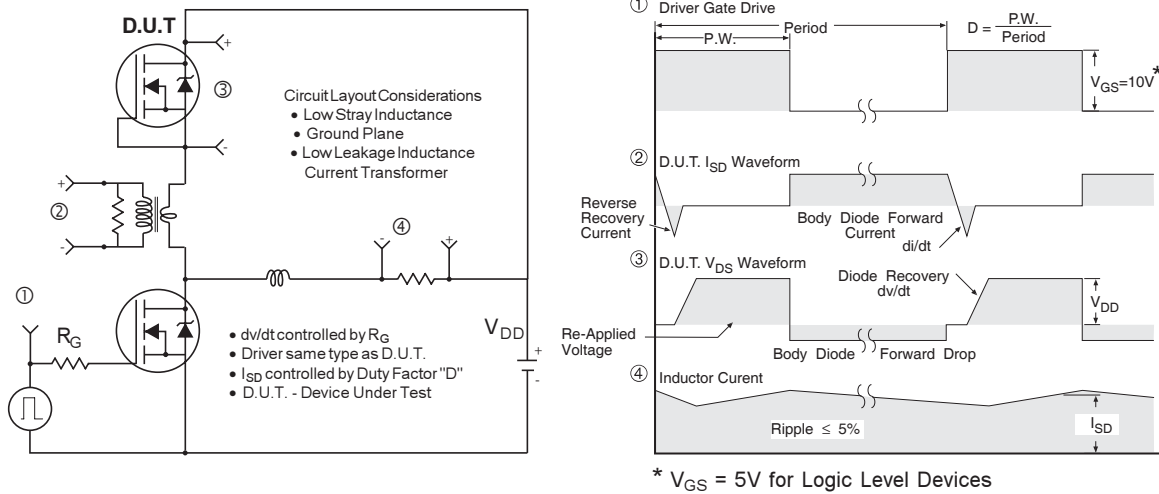

**Fig 16. Peak Diode Recovery dv/dt Test Circuit for N-Channel HEXFET® Power MOSFETs**

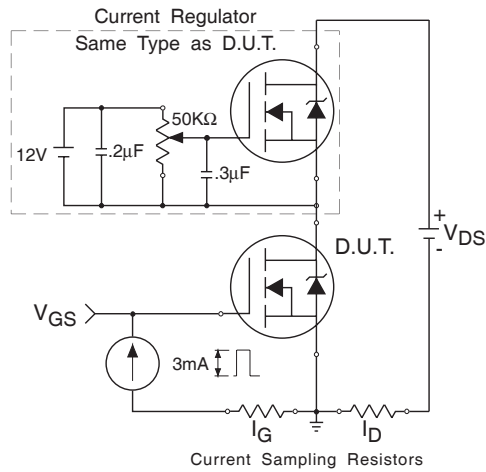

**Fig 17. Gate Charge Test Circuit**

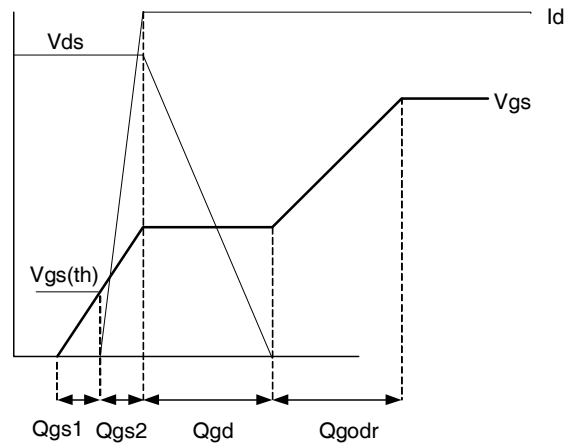
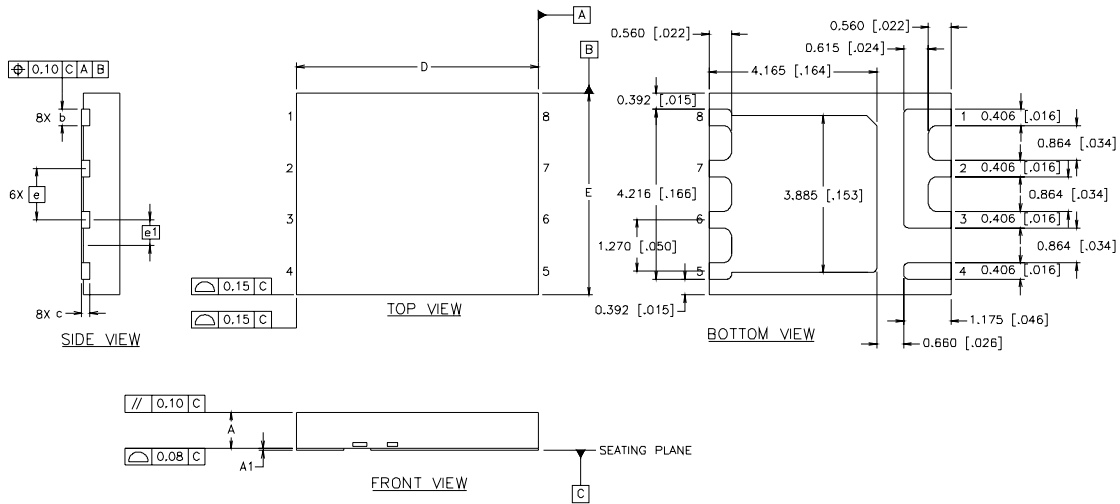

**Fig 18. Gate Charge Waveform**

# IRFH7914PbF

## PQFN Package Details

International  
**IR** Rectifier



DIM	INCHES		MILLIMETERS	
	MIN	MAX	MIN	MAX
A	.0315	.0394	0.800	1.000
A1	.0000	.0020	0.000	0.050
b	.0140	.0180	0.356	0.456
c	.0080 REF.		0.203 REF.	
D	.2362 BASIC		6.0 BASIC	
E	.1969 BASIC		5.0 BASIC	
e	.0500 BASIC		1.270 BASIC	
e1	.0250 BASIC		0.635 BASIC	

## PQFN Part Marking

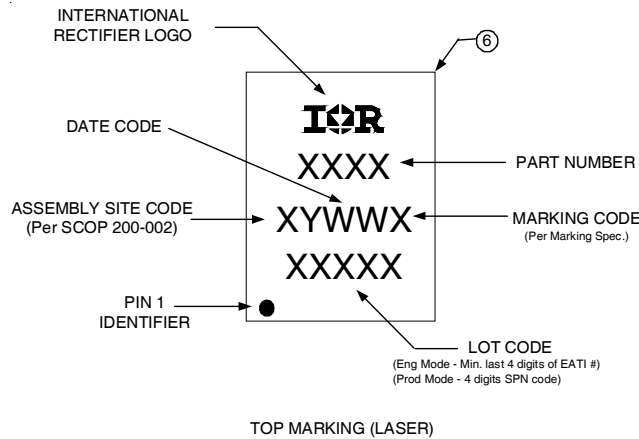

Note: For the most current drawing please refer to IR website at <http://www.irf.com/package/>



## PQFN Tape and Reel

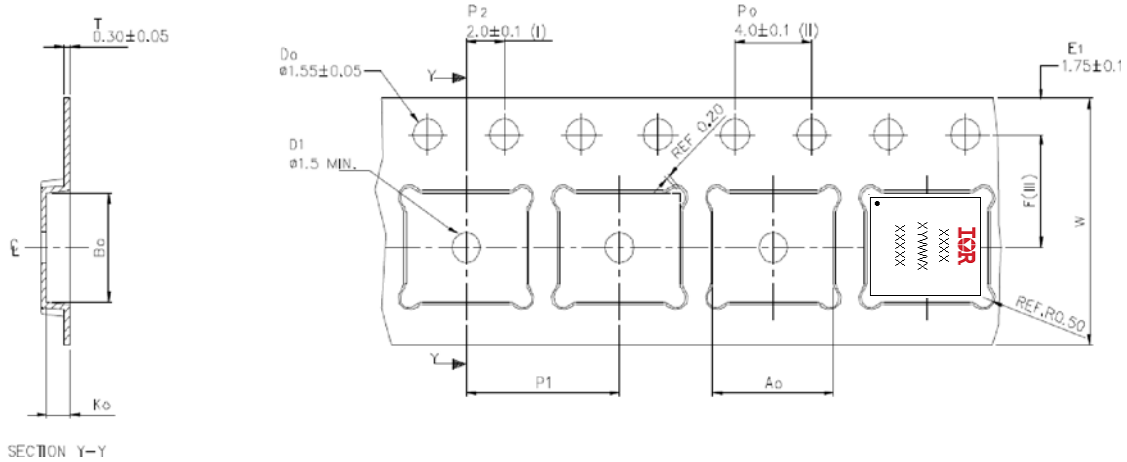

A <sub>0</sub>	6.30 +/− 0.1
B <sub>0</sub>	5.30 +/− 0.1
K <sub>0</sub>	1.20 +/− 0.1
F	5.50 +/− 0.1
P <sub>1</sub>	8.00 +/− 0.1
W	12.00 +/− 0.3

- (I) Measured from centreline of sprocket hole to centreline of pocket.
- (II) Cumulative tolerance of 10 sprocket holes is ± 0.20 .
- (III) Measured from centreline of sprocket hole to centreline of pocket.
- (IV) Other material available.
- (V) Typical SR of form tape Max 10<sup>9</sup> OHM/SQ

ALL DIMENSIONS IN MILLIMETRES UNLESS OTHERWISE STATED.

### Notes:

- ① Repetitive rating; pulse width limited by max. junction temperature.
- ② Starting T<sub>J</sub> = 25°C, L = 0.27mH, R<sub>G</sub> = 25Ω, I<sub>AS</sub> = 11A.
- ③ Pulse width ≤ 400μs; duty cycle ≤ 2%.
- ④ R<sub>thjc</sub> is guaranteed by design
- ⑤ When mounted on 1 inch square 2 oz copper pad on 1.5x1.5 in. board of FR-4 material.

**Note:** For the most current drawing please refer to IR website at <http://www.irf.com/package/>

Data and specifications subject to change without notice.  
 This product has been designed and qualified for the Consumer market.  
 Qualification Standards can be found on IR's Web site.

International  
**IR** Rectifier

**IR WORLD HEADQUARTERS:** 233 Kansas St., El Segundo, California 90245, USA Tel: (310) 252-7105  
 TAC Fax: (310) 252-7903

Visit us at [www.irf.com](http://www.irf.com) for sales contact information.07/08