

INTERNATIONAL RECTIFIER

INTERNATIONAL RECTIFIER 

HEXFET® TRANSISTORS
N-CHANNEL
HEXDIP™

1-WATT RATED POWER MOSFETs
IN A 4-PIN, DUAL-IN-LINE PACKAGE

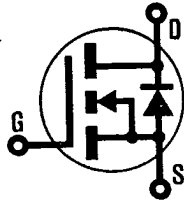

IRFD020
IRFD022

4-PIN DIP

50 Volt, 0.10 Ohm, 1-Watt HEXDIP

HEXFET technology is the key to International Rectifier's advanced line of power MOSFET transistors. Efficient geometry and unique processing of the HEXFET design achieve a very low on-state resistance combined with high transconductance and great device ruggedness. HEXFETs feature all of the established advantages of MOSFETs such as voltage control, very fast switching, ease of paralleling, and temperature stability of the electrical parameters.

The HEXDIP 4-pin, Dual-In-Line Package brings the advantages of HEXFETs to high volume applications where automatic PC Board insertion is desirable, such as circuit boards for computers, printers, telecommunications equipment and consumer products. Their compatibility with automatic insertion equipment, low-profile and end-stackable features represent the state-of-the-art in power device packaging

FEATURES:

- For Automatic Insertion
- Compact, End Stackable
- Fast Switching
- Low Drive Current
- Easily Paralleled
- Excellent Temperature Stability

Product Summary

Part Number	V _{DS}	R _{DS(on)}	I _D
IRFD020	50V	0.10Ω	2.4A
IRFD022	60V	0.12Ω	2.2A

CASE STYLE AND DIMENSIONS

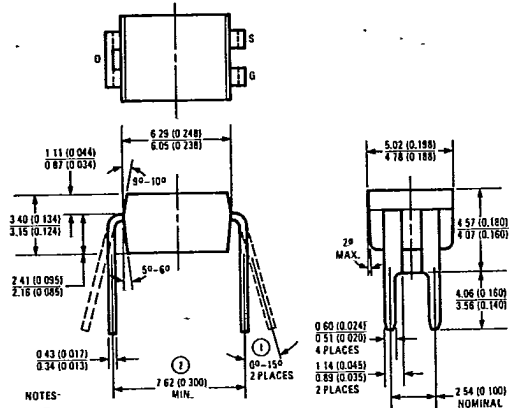
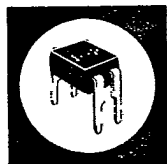
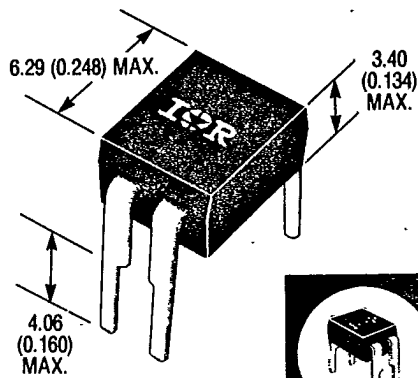

- NOTES:
 ① APPLIES TO SPREAD OF LEADS PRIOR TO INSTALLATION
 ② APPLIES TO INSTALLED LEAD CENTERS.

Case Style HD-1 (Similar to JEDEC Outline MO-001)
Dimensions in Millimeters and (Inches)

IRFD020, IRFD022 Devices

INTERNATIONAL RECTIFIER

T-35-25

Absolute Maximum Ratings

Parameter	IRFD020	IRFD022	Units
V _{DS} Drain - Source Voltage ①	50	50	V
V _{DGR} Drain - Gate Voltage (R _{GS} = 20 kΩ) ①	50	50	V
I _D @ T _C = 25°C Continuous Drain Current	2.4	2.2	A
I _D @ T _C = 100°C Continuous Drain Current	1.5	1.4	A
I _{DM} Pulsed Drain Current ②	19	18	A
V _{GS} Gate - Source Voltage	±20		V
P _D @ T _C = 25°C Max. Power Dissipation	1.0		W
Linear Derating Factor	0.0080		W/K ③
I _{LM} Inductive Current, Clamped	(See Fig. 14) L = 100 μH		A
I _L Unclamped Inductive Current (Avalanche Current) ④	(See Fig. 15)		A
T _J Operating Junction and Storage Temperature Range	-55 to 150		°C
T _{stg} Lead Temperature	300 (0.063 in. (1.6mm) from case for 10s)		°C

Electrical Characteristics @ T_C = 25°C (Unless Otherwise Specified)

Parameter	Type	Min.	Typ.	Max.	Units	Test Conditions
BV _{DSS} Drain - Source Breakdown Voltage	IRFD020	50	—	—	V	V _{GS} = 0V
	IRFD022	—	—	—	V	I _D = -250 μA
V _{GS(th)} Gate Threshold Voltage	ALL	2.0	—	4.0	V	V _{DS} = V _{GS} ; I _D = 250 μA
I _{GSS} Gate-Source Leakage Forward	ALL	—	—	500	nA	V _{GS} = 20V
I _{GSS} Gate-Source Leakage Reverse	ALL	—	—	-500	nA	V _{GS} = -20V
I _{DSS} Zero Gate Voltage Drain Current	ALL	—	—	250	μA	V _{DS} = Max. Rating, V _{GS} = 0V
		—	—	1000	μA	V _{DS} = Max. Rating × 0.8, V _{GS} = 0V, T _C = 125°C
I _{D(on)} On-State Drain Current ⑤	IRFD020	2.4	—	—	A	V _{DS} > I _{D(on)} × R _{DS(on)max} ; V _{GS} = 10V
	IRFD022	2.2	—	—	A	
R _{DS(on)} Static Drain-Source On-State Resistance ⑥	IRFD020	—	0.080	0.10	Ω	V _{GS} = 10V, I _D = 1.4A
	IRFD022	—	0.11	0.12	Ω	
g _{fs} Forward Transconductance ⑦	ALL	4.9	7.3	—	S/(V)	V _{DS} = 2 × V _{GS} ; I _{DS} = 7.5A
C _{iss} Input Capacitance	ALL	—	400	—	pF	V _{GS} = 0V, V _{DS} = 25V, f = 1.0 MHz
C _{oss} Output Capacitance	ALL	—	260	—	pF	See Fig. 10
C _{rss} Reverse Transfer Capacitance	ALL	—	44	—	pF	
t _{d(on)} Turn-On Delay Time	ALL	—	8.7	13	ns	V _{DD} = 25V, I _D ≈ 15A, R _G = 18Ω, R _D = 1.7Ω
t _r Rise Time	ALL	—	55	83	ns	See Fig. 16
t _{d(off)} Turn-Off Delay Time	ALL	—	16	24	ns	(MOSFET switching times are essentially independent of operating temperature.)
t _f Fall Time	ALL	—	26	39	ns	
Q _g Total Gate Charge (Gate-Source Plus Gate-Drain)	ALL	—	16	24	nC	V _{GS} = 10V, I _D = 15A, V _{DS} = 0.8 Max. Rating. See Fig. 17 for test circuit. (Gate charge is essentially independent of operating temperature.)
Q _{gs} Gate-Source Charge	ALL	—	4.7	7.1	nC	
Q _{gd} Gate-Drain ("Miller") Charge	ALL	—	4.7	7.1	nC	
L _D Internal Drain Inductance	ALL	—	4.0	—	nH	Measured from the drain lead, 6mm (0.25 in.) from package to center of die.
L _S Internal Source Inductance	ALL	—	6.0	—	nH	Measured from the source lead, 6mm (0.25 in.) from package to source bonding pad.

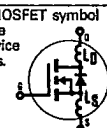

Thermal Resistance

R _{thJA} Junction-to-Ambient	ALL	—	—	120	K/W ⑧	Typical socket mount
---------------------------------------	-----	---	---	-----	-------	----------------------

Source-Drain Diode Ratings and Characteristics

I_S Continuous Source Current (Body Diode)	IRFD020	—	—	2.4	A	Modified MOSFET symbol showing the integral reverse P-N junction rectifier. 
	IRFD022	—	—	2.2	A	
I_{SM} Pulse Source Current (Body Diode) ②	IRFD020	—	—	19	A	
	IRFD022	—	—	18	A	
V_{SD} Diode Forward Voltage ②	ALL	—	—	1.4	V	$T_C = 25^\circ\text{C}, I_S = 2.4\text{A}, V_{GS} = 0\text{V}$
t_{rr} Reverse Recovery Time	ALL	57	130	310	ns	$T_J = 25^\circ\text{C}, I_F = 15\text{A}, dI_F/dt = 100\text{A}/\mu\text{s}$
Q_{RR} Reverse Recovered Charge	ALL	0.17	0.34	0.85	μC	$T_J = 25^\circ\text{C}, I_F = 15\text{A}, dI_F/dt = 100\text{A}/\mu\text{s}$
t_{on} Forward Turn-on Time	ALL	Intrinsic turn-on time is negligible. Turn-on speed is substantially controlled by $L_S + L_D$.				

- ① $T_J = 25^\circ\text{C}$ to 150°C
- ② Repetitive Rating: Pulse width limited by max. junction temperature. See Transient Thermal Impedance Curve (Fig. 5).
- ③ @ $V_{dd} = 25\text{V}, T_J = 25^\circ\text{C}$
 $L = 100 \mu\text{H}, R_G = 25\Omega$
- ④ Pulse Test: Pulse width $\leq 300 \mu\text{s}$, Duty Cycle $\leq 2\%$
- ⑤ $\text{K/W} = \text{C/W}$
 $\text{W/K} = \text{W}/^\circ\text{C}$

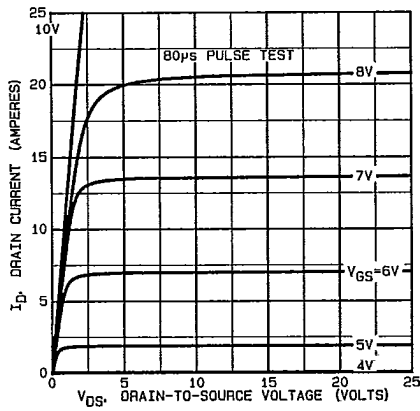

Fig. 1 — Typical Output Characteristics

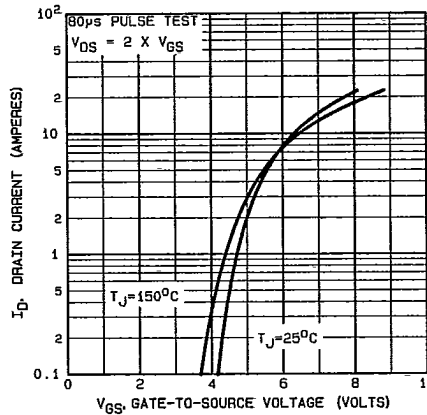

Fig. 2 — Typical Transfer Characteristics

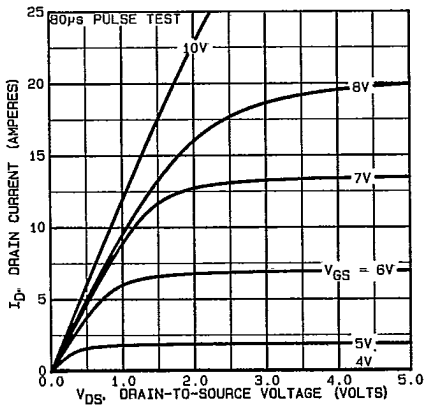

Fig. 3 — Typical Saturation Characteristics

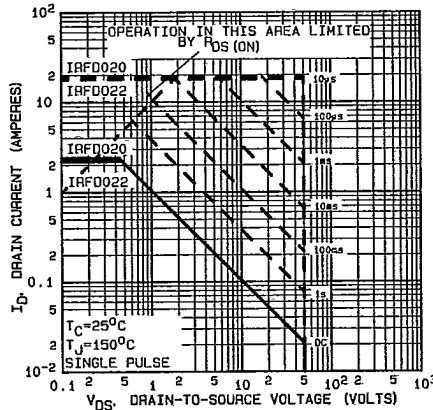

Fig. 4 — Maximum Safe Operating Area

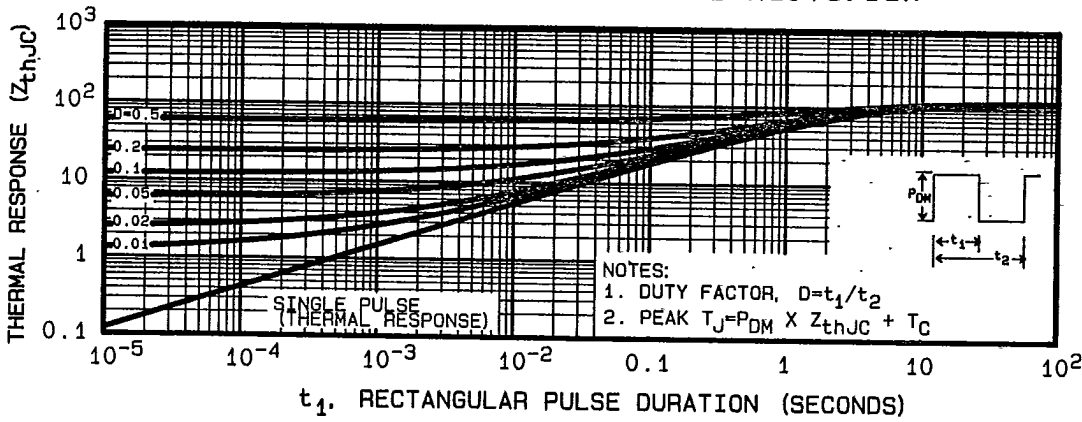

Fig. 5 — Maximum Effective Transient Thermal Impedance, Junction-to-Case Vs. Pulse Duration

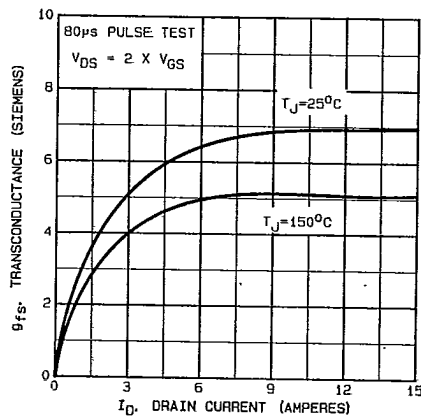

Fig. 6 — Typical Transconductance Vs. Drain Current

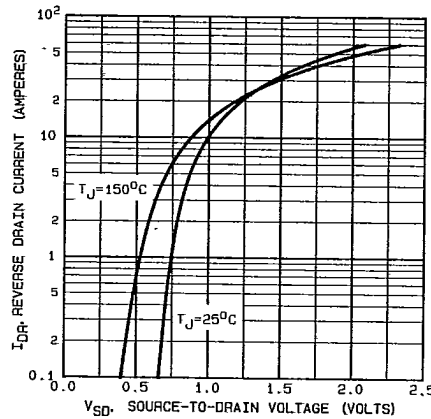

Fig. 7 — Typical Source-Drain Diode Forward Voltage

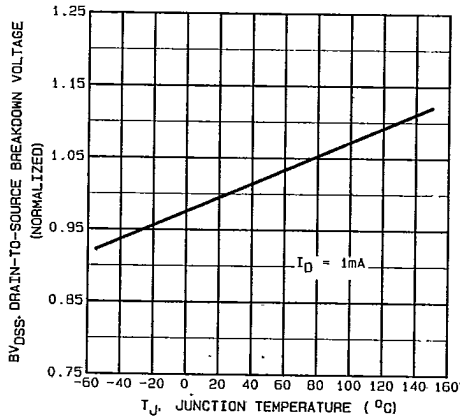

Fig. 8 — Breakdown Voltage Vs. Temperature

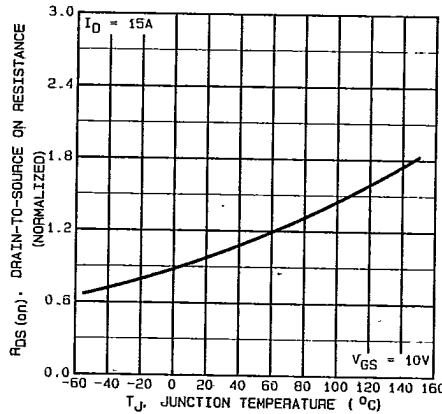

Fig. 9 — Normalized On-Resistance Vs. Temperature

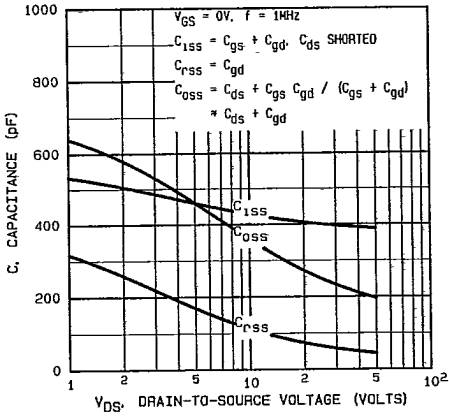

Fig. 10 — Typical Capacitance Vs. Drain-to-Source Voltage

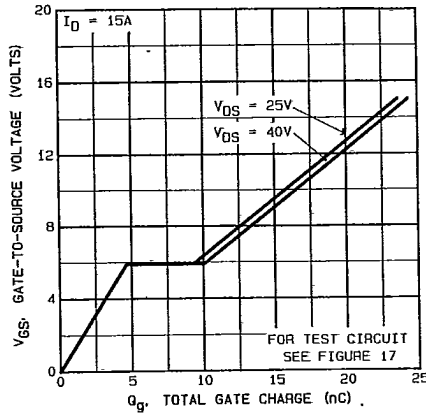

Fig. 11 — Typical Gate Charge Vs. Gate-to-Source Voltage

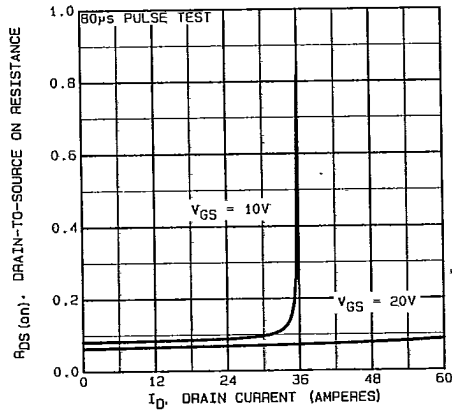

Fig. 12 — Typical On-Resistance Vs. Drain Current

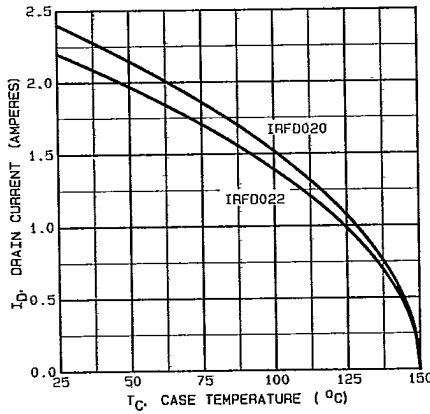

Fig. 13 — Maximum Drain Current Vs. Case Temperature

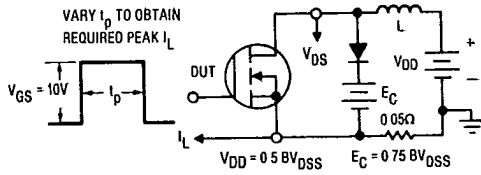

Fig. 14a — Clamped Inductive Test Circuit

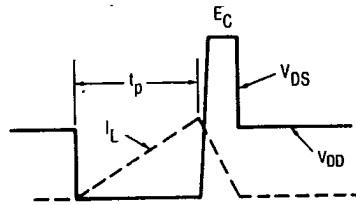

Fig. 14b — Clamped Inductive Waveforms

IRFD020, IRFD022 Devices

INTERNATIONAL RECTIFIER

T-35-25

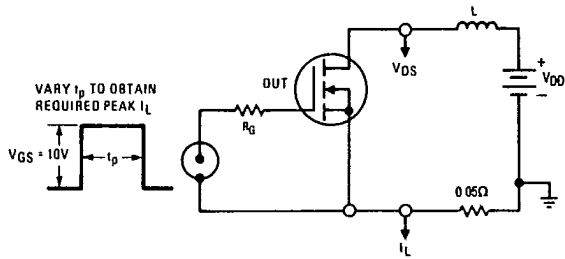

Fig. 15a — Unclamped Inductive Test Circuit

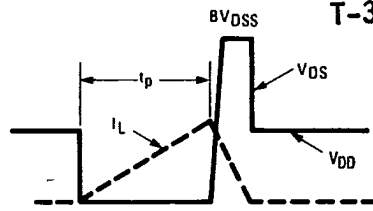

Fig. 15b — Unclamped Inductive Load Test Waveforms

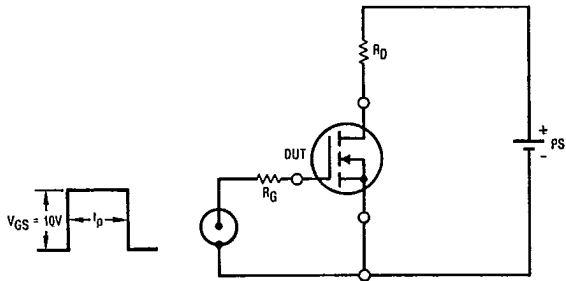

Fig. 16 — Switching Time Test Circuit

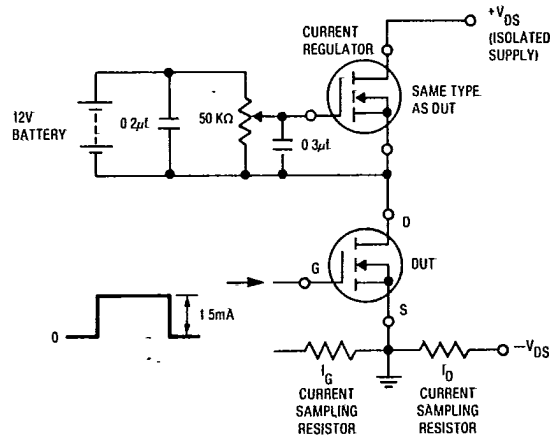
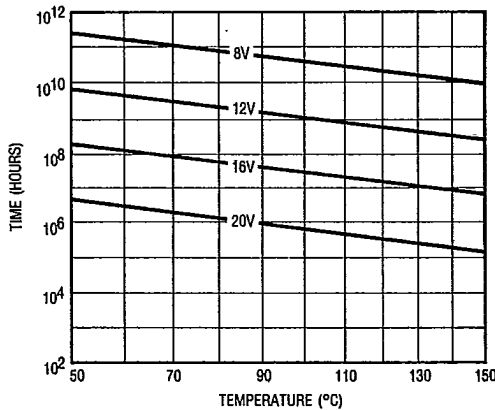
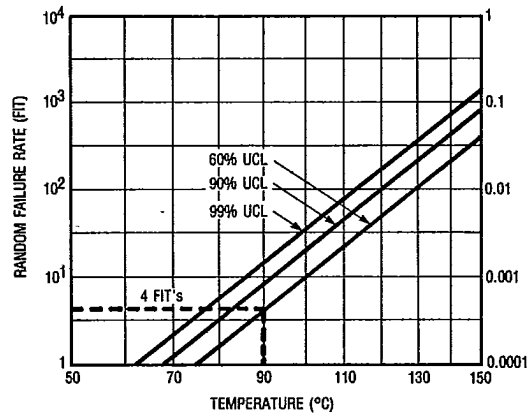

Fig. 17 — Gate Charge Test Circuit



***Fig. 18 — Typical Time to Accumulated 1% Gate Failure**



***Fig. 19 — Typical High Temperature Reverse Bias (HTRB) Failure Rate**

*The data shown is correct as of April 15, 1987. This information is updated on a quarterly basis; for the latest reliability data, please contact your local IR field office.