

7.4 x 3.4 x 1.8 mm SMD CERAMIC RESONATOR

AWSZT-MGD

Pb in ceramic
(exempt per RoHS 2002/95/EC Annex (7))

RoHS
Compliant

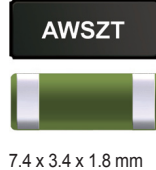

FEATURES:

- Low resonant impedance
- IR reflow capable
- Low cost

APPLICATIONS:

- Remote controls, Microprocessor clocks, Mobile phones, DVD & CD-Roms, Electric appliances
- Consumer electronics

ELECTRICAL CHARACTERISTICS:

Item	Requirement
Frequency Range	2.00MHz to 8.00MHz
Resonant Impedance	See Table
Frequency Tolerance	± 0.5%
Frequency Stability	±0.3% max. (-25°C to +85°C)*
Withstanding Voltage	50V (DC , 1 min)
Rating Voltage	
(1) D.C. Voltage	6 V.D.C. max
(2) A.C. Voltage	15 Vp-p. max
Load Capacitance	30pF ±20% (C1=C2)
Insulation Resistance	100MΩ min. (10V, 1min)
Operation Temperature	-25°C to +85°C*
Storage Temperature	-55°C to +85°C
Aging Rate (Fosc)	±0.3% max. (10 years)

Table

Frequency Range (MHz)	Resonant Impedance (Ro)(Ω)
2.00 MHz - 2.99 MHz	100 max
3.00 MHz - 3.49 MHz	50 max
3.50 MHz - 8.00 MHz	30 max

* Please contact ABRACON for tighter stability and/or wider temperature range

TEST CONDITION AND TEST CIRCUIT:

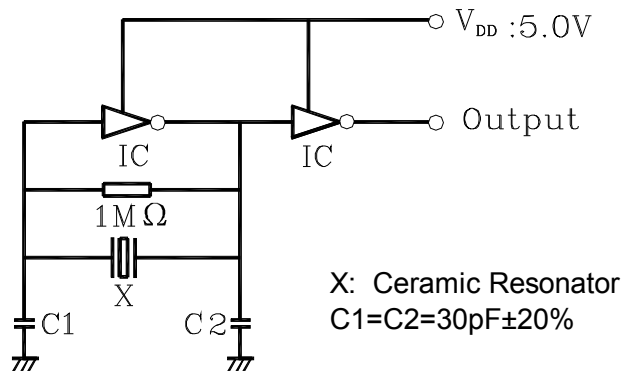

Parts shall be measured under a condition (Temp.: 20±15°C, Humidity: 65±20% R.H.) unless the standard condition (Temp: 25±3°C, Humidity: 65±10% R.H.) is regulated to measure

OPTIONS & PART IDENTIFICATION:

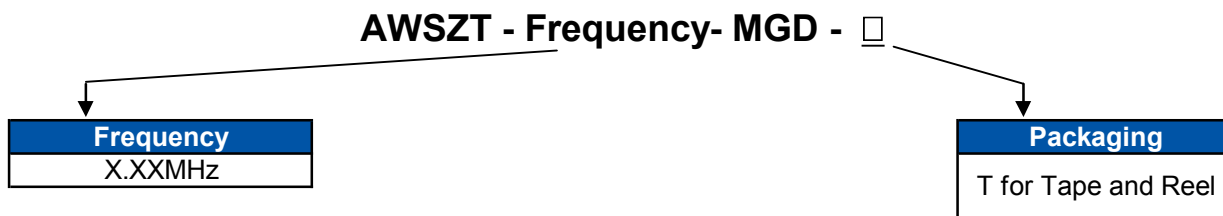

7.4 x 3.4 x 1.8 mm SMD CERAMIC RESONATOR

AWSZT



7.4 x 3.4 x 1.8 mm

AWSZT-MGD

Pb in ceramic
(exempt per RoHS 2002/95/EC Annex (7))

RoHS
Compliant

OUTLINE DRAWING:

Dimensions: mm

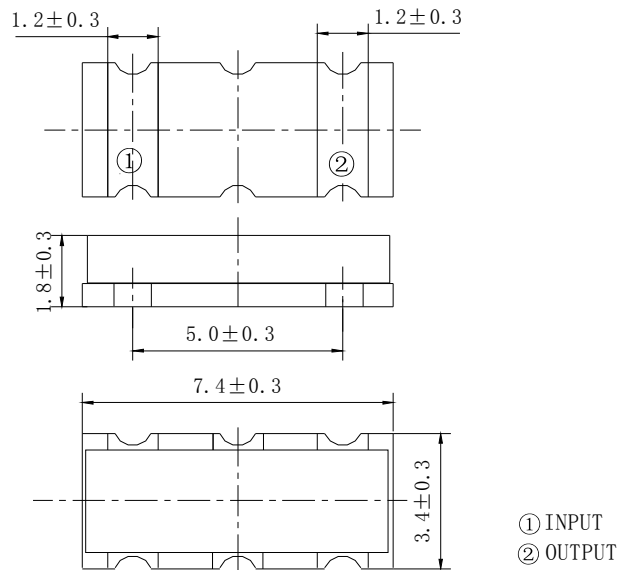

RECOMMENDED LAND PATTERN

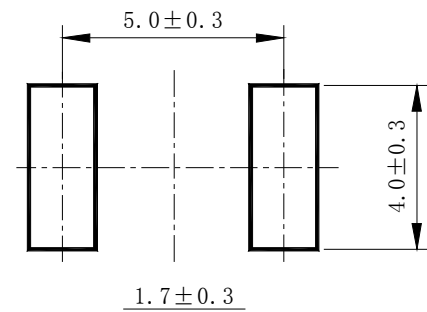

TAPE & REEL: (4,000pcs/reel)

Dimensions: mm

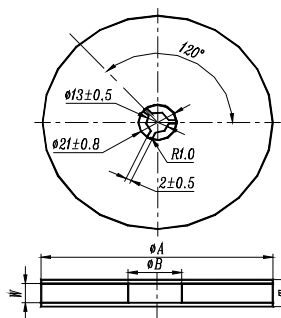

φ A	φ B	W	T	Pieces per reel	Carrier tape size
330 ± 3	80min	16.4min	22.4max	4000typ.	16

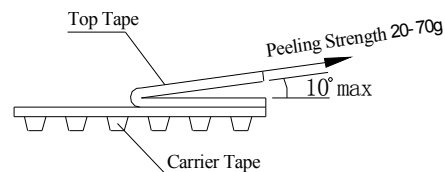
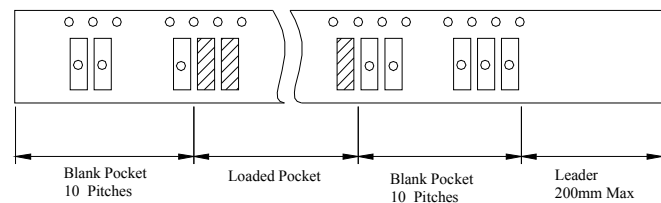

7.4 x 3.4 x 1.8 mm SMD CERAMIC RESONATOR

AWSZT

AWSZT-MGD

Pb in ceramic
(exempt per RoHS 2002/95/EC Annex (7))

RoHS
Compliant



7.4 x 3.4 x 1.8 mm

REFLOW PROFILE:

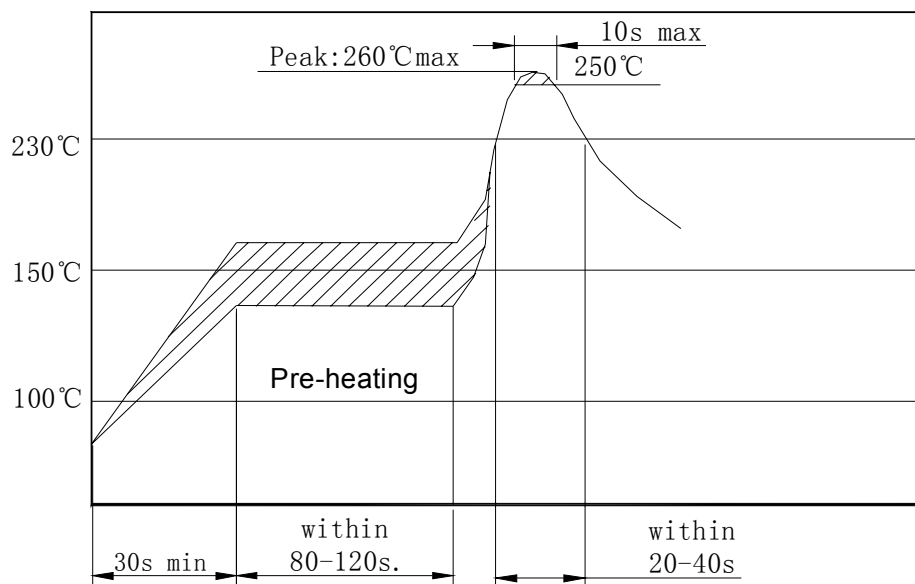

CAUTION

- Do not apply excess mechanical stress to the component body or terminations. Do not attempt to re-form or bend the components as this will cause damage to the component.
- This component is not hermetically sealed. Do not clean or wash the component.
- Reflow soldering: Do not use strong acidity flux, such as flux with chlorine content of greater than 0.2wt% during reflow Soldering.
- Do not expose the component to open flame.
- This specification applies to the functionality of the component as a single unit. Customers are advised to insure that the component is thoroughly evaluated in the particular application.
- Shelf life: The warranted shelf life of this product is six months after the delivery date under the conditions of sealed, unopened, original packaging.
- Storage conditions: If the product is to be stored for a period greater than six months after the delivery date, it is recommended that customers confirm the solderability and characteristics for the product prior to use.
- This product is not recommended for use in the following applications: Automotive, Medical, Military, Safety, or any other high-reliability, life-dependant application. Contact Abracon Corporation prior to using this product when in doubt.

ATTENTION: Abracon Corporation's products are COTS – Commercial-Off-The-Shelf products; suitable for Commercial, Industrial and, where designated, Automotive Applications. Abracon's products are not specifically designed for Military, Aviation, Aerospace, Life-dependant Medical applications or any application requiring high reliability where component failure could result in loss of life and/or property. For applications requiring high reliability and/or presenting an extreme operating environment, written consent and authorization from Abracon Corporation is required. Please contact Abracon Corporation for more information.

ABRACON IS
ISO9001:2008
CERTIFIED

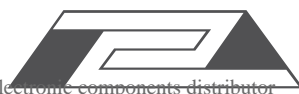

ABRACON
CORPORATION

Visit www.abracon.com for Terms & Conditions of Sale **Revised: 09.05.10**

30332 Esperanza, Rancho Santa Margarita, California 92688

tel 949-546-8000 | fax 949-546-8001 | www.abracon.com