

## AOD407

### P-Channel Enhancement Mode Field Effect Transistor

#### General Description

The AOD407 uses advanced trench technology to provide excellent  $R_{DS(ON)}$ , low gate charge and low gate resistance. With the excellent thermal resistance of the DPAK package, this device is well suited for high current load applications.

- RoHS Compliant
- Halogen Free\*

#### Features

- $V_{DS}$  (V) = -60V
- $I_D$  = -12A ( $V_{GS}$  = -10V)
- $R_{DS(ON)} < 115m\Omega$  ( $V_{GS}$  = -10V)
- $R_{DS(ON)} < 150m\Omega$  ( $V_{GS}$  = -4.5V)
- 100% UIS tested
- 100% RG tested

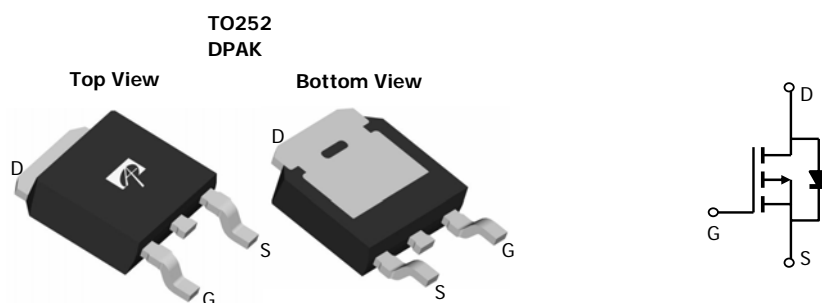

#### Absolute Maximum Ratings $T_A=25^\circ\text{C}$ unless otherwise noted

Parameter	Symbol	Maximum	Units
Drain-Source Voltage	$V_{DS}$	-60	V
Gate-Source Voltage	$V_{GS}$	$\pm 20$	V
Continuous Drain Current <sup>G</sup>	$I_D$	$T_C=25^\circ\text{C}$	-12
		$T_C=100^\circ\text{C}$	-10
Pulsed Drain Current <sup>C</sup>	$I_{DM}$	-30	A
Avalanche Current <sup>C</sup>	$I_{AR}$	-12	A
Repetitive avalanche energy $L=0.1mH$ <sup>C</sup>	$E_{AR}$	23	mJ
Power Dissipation <sup>B</sup>	$P_D$	$T_C=25^\circ\text{C}$	50
		$T_C=100^\circ\text{C}$	25
Power Dissipation <sup>A</sup>	$P_{DSM}$	$T_A=25^\circ\text{C}$	2.5
		$T_A=70^\circ\text{C}$	1.6
Junction and Storage Temperature Range	$T_J, T_{STG}$	-55 to 175	$^\circ\text{C}$

#### Thermal Characteristics

Parameter	Symbol	Typ	Max	Units
Maximum Junction-to-Ambient <sup>A</sup>	$R_{\theta JA}$	$t \leq 10s$	16.7	$^\circ\text{C/W}$
Maximum Junction-to-Ambient <sup>A</sup>		Steady-State	40	$^\circ\text{C/W}$
Maximum Junction-to-Case <sup>B</sup>	$R_{\theta JC}$	2.5	3	$^\circ\text{C/W}$

Electrical Characteristics ( $T_J=25^\circ\text{C}$  unless otherwise noted)

Symbol	Parameter	Conditions	Min	Typ	Max	Units
<b>STATIC PARAMETERS</b>						
$BV_{DSS}$	Drain-Source Breakdown Voltage	$I_D=-250\mu\text{A}$ , $V_{GS}=0\text{V}$	-60			V
$I_{DSS}$	Zero Gate Voltage Drain Current	$V_{DS}=-48\text{V}$ , $V_{GS}=0\text{V}$ $T_J=55^\circ\text{C}$		-0.003	-1	$\mu\text{A}$
$I_{GSS}$	Gate-Body leakage current	$V_{DS}=0\text{V}$ , $V_{GS}=\pm 20\text{V}$			$\pm 100$	nA
$V_{GS(th)}$	Gate Threshold Voltage	$V_{DS}=V_{GS}$ , $I_D=-250\mu\text{A}$	-1.5	-2.1	-3	V
$I_{D(ON)}$	On state drain current	$V_{GS}=-10\text{V}$ , $V_{DS}=-5\text{V}$	-30			A
$R_{DS(ON)}$	Static Drain-Source On-Resistance	$V_{GS}=-10\text{V}$ , $I_D=-12\text{A}$ $T_J=125^\circ\text{C}$		91	115	$\text{m}\Omega$
		$V_{GS}=-4.5\text{V}$ , $I_D=-8\text{A}$		114	150	$\text{m}\Omega$
$g_{FS}$	Forward Transconductance	$V_{DS}=-5\text{V}$ , $I_D=-12\text{A}$		12.8		S
$V_{SD}$	Diode Forward Voltage	$I_S=-1\text{A}$ , $V_{GS}=0\text{V}$		-0.76	-1	V
$I_S$	Maximum Body-Diode Continuous Current				-12	A
<b>DYNAMIC PARAMETERS</b>						
$C_{iss}$	Input Capacitance	$V_{GS}=0\text{V}$ , $V_{DS}=-30\text{V}$ , $f=1\text{MHz}$		987	1185	pF
$C_{oss}$	Output Capacitance			114		pF
$C_{rss}$	Reverse Transfer Capacitance			46		pF
$R_g$	Gate resistance	$V_{GS}=0\text{V}$ , $V_{DS}=0\text{V}$ , $f=1\text{MHz}$		7	10	$\Omega$
<b>SWITCHING PARAMETERS</b>						
$Q_g(10\text{V})$	Total Gate Charge (10V)	$V_{GS}=-10\text{V}$ , $V_{DS}=-30\text{V}$ , $I_D=-12\text{A}$		15.8	20	nC
$Q_g(4.5\text{V})$	Total Gate Charge (4.5V)			7.4	9	nC
$Q_{gs}$	Gate Source Charge			3		nC
$Q_{gd}$	Gate Drain Charge			3.5		nC
$t_{D(on)}$	Turn-On Delay Time	$V_{GS}=-10\text{V}$ , $V_{DS}=-30\text{V}$ , $R_L=2.5\Omega$ , $R_{GEN}=3\Omega$		9		ns
$t_r$	Turn-On Rise Time			10		ns
$t_{D(off)}$	Turn-Off Delay Time			25		ns
$t_f$	Turn-Off Fall Time			11		ns
$t_{rr}$	Body Diode Reverse Recovery Time	$I_F=-12\text{A}$ , $dI/dt=100\text{A}/\mu\text{s}$		27.5	35	ns
$Q_{rr}$	Body Diode Reverse Recovery Charge	$I_F=-12\text{A}$ , $dI/dt=100\text{A}/\mu\text{s}$		30		nC

A: The value of  $R_{\theta JA}$  is measured with the device mounted on 1 in 2 FR-4 board with 2oz. Copper, in a still air environment with  $T_A=25^\circ\text{C}$ . The Power dissipation  $P_{DSM}$  is based on  $R_{\theta JA}$  and the maximum allowed junction temperature of  $150^\circ\text{C}$ . The value in any given application depends on the user's specific board design, and the maximum temperature of  $175^\circ\text{C}$  may be used if the PCB allows it.

B: The power dissipation  $P_D$  is based on  $T_{J(MAX)}=175^\circ\text{C}$ , using junction-to-case thermal resistance, and is more useful in setting the upper dissipation limit for cases where additional heatsinking is used.

C: Repetitive rating, pulse width limited by junction temperature  $T_{J(MAX)}=175^\circ\text{C}$ .

D: The  $R_{\theta JA}$  is the sum of the thermal impedance from junction to case  $R_{\theta JC}$  and case to ambient.

E: The static characteristics in Figures 1 to 6 are obtained using  $<300 \mu\text{s}$  pulses, duty cycle 0.5% max.

F: These curves are based on the junction-to-case thermal impedance which is measured with the device mounted to a large heatsink, assuming a maximum junction temperature of  $T_{J(MAX)}=175^\circ\text{C}$ .

G: The maximum current rating is limited by bond-wires.

H: These tests are performed with the device mounted on 1 in 2 FR-4 board with 2oz. Copper, in a still air environment with  $T_A=25^\circ\text{C}$ . The SOA curve provides a single pulse rating.

\*This device is guaranteed green after data code 8X11 (Sep 1<sup>ST</sup> 2008).

Rev 7 : May 2010

THIS PRODUCT HAS BEEN DESIGNED AND QUALIFIED FOR THE CONSUMER MARKET. APPLICATIONS OR USES AS CRITICAL COMPONENTS IN LIFE SUPPORT DEVICES OR SYSTEMS ARE NOT AUTHORIZED. AOS DOES NOT ASSUME ANY LIABILITY ARISING OUT OF SUCH APPLICATIONS OR USES OF ITS PRODUCTS. AOS RESERVES THE RIGHT TO IMPROVE PRODUCT DESIGN, FUNCTIONS AND RELIABILITY WITHOUT NOTICE

TYPICAL ELECTRICAL AND THERMAL CHARACTERISTICS

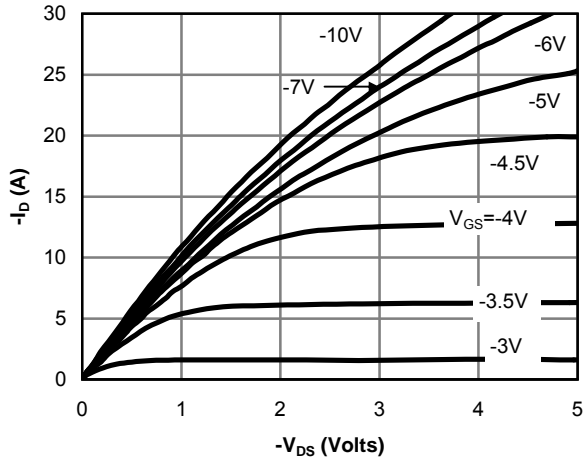

Fig 1: On-Region Characteristics

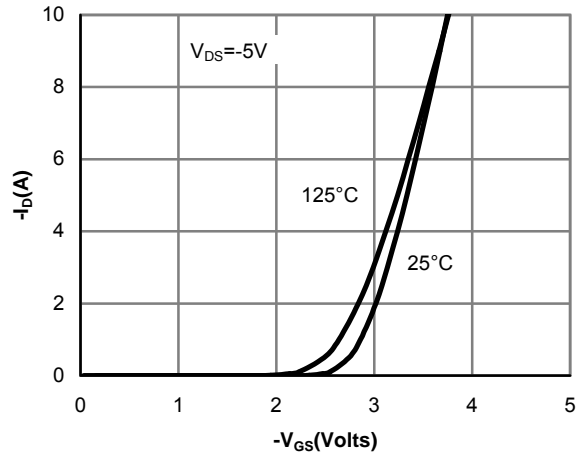

Figure 2: Transfer Characteristics

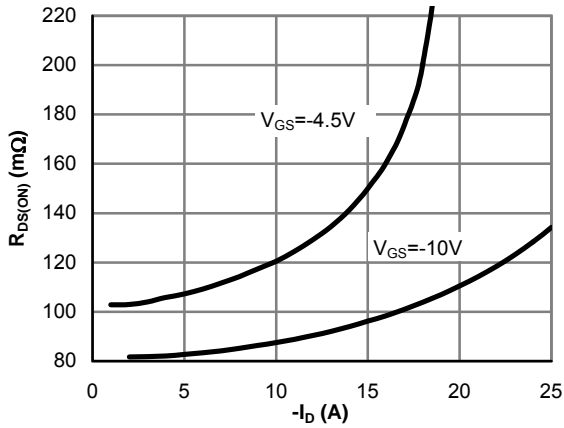

Figure 3: On-Resistance vs. Drain Current and Gate Voltage

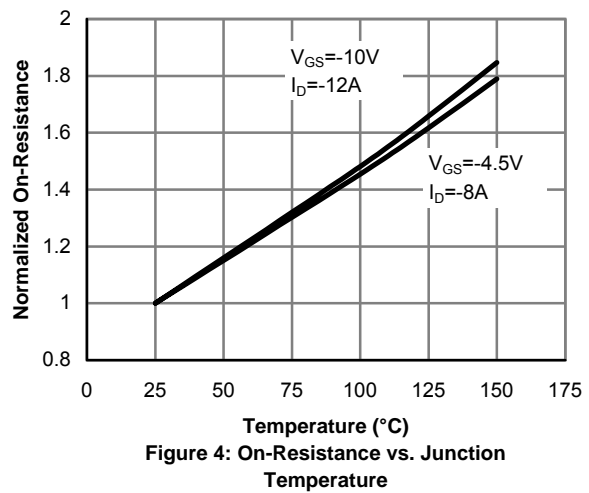

Figure 4: On-Resistance vs. Junction Temperature

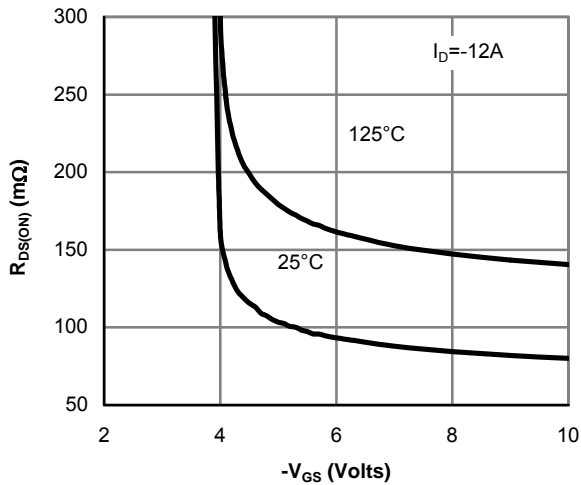

Figure 5: On-Resistance vs. Gate-Source Voltage

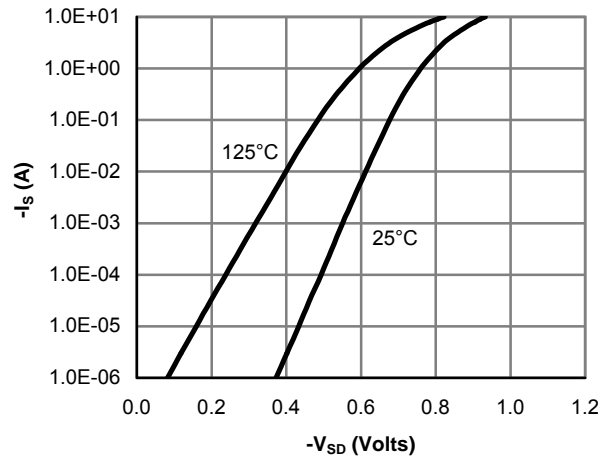

Figure 6: Body-Diode Characteristics

TYPICAL ELECTRICAL AND THERMAL CHARACTERISTICS

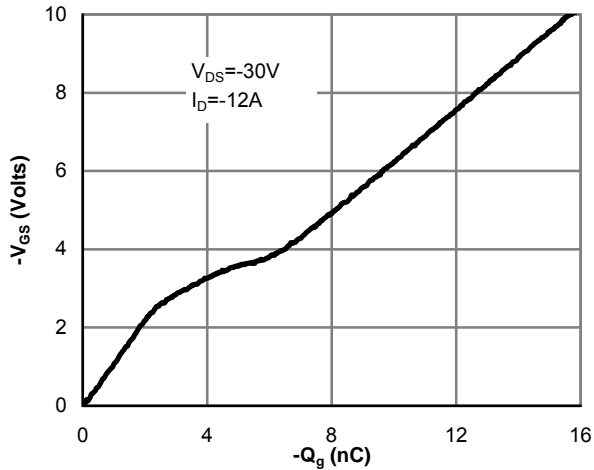

Figure 7: Gate-Charge Characteristics

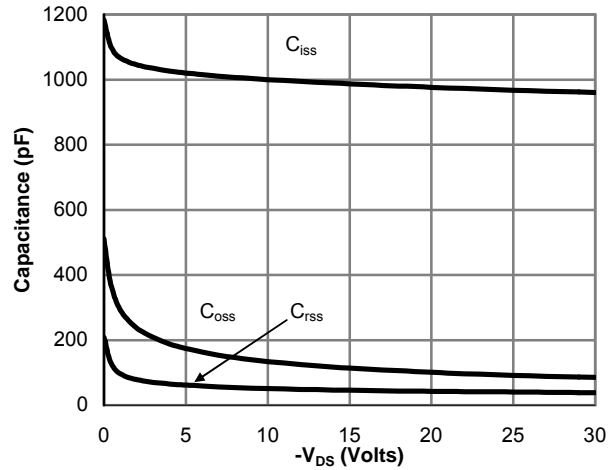

Figure 8: Capacitance Characteristics

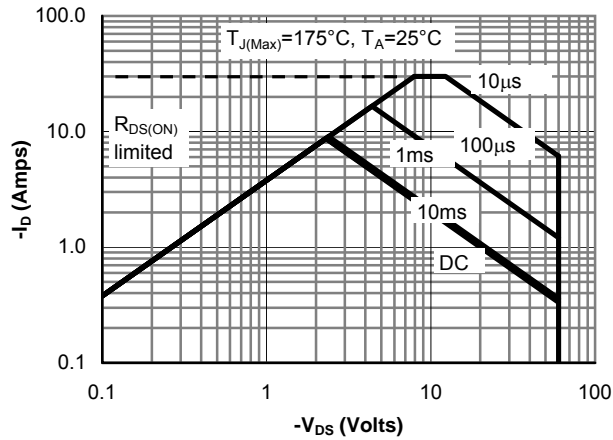

Figure 9: Maximum Forward Biased Safe Operating Area (Note F)

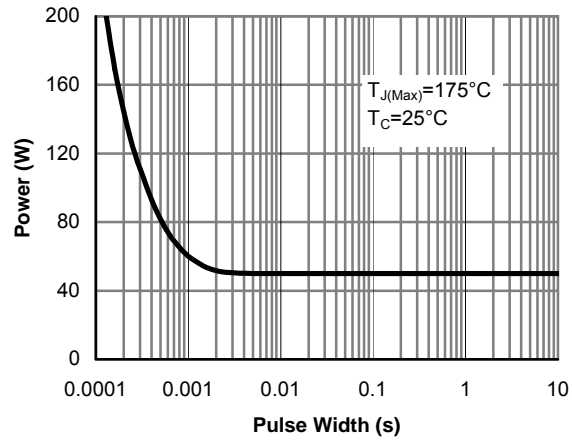

Figure 10: Single Pulse Power Rating Junction-to-Case (Note F)

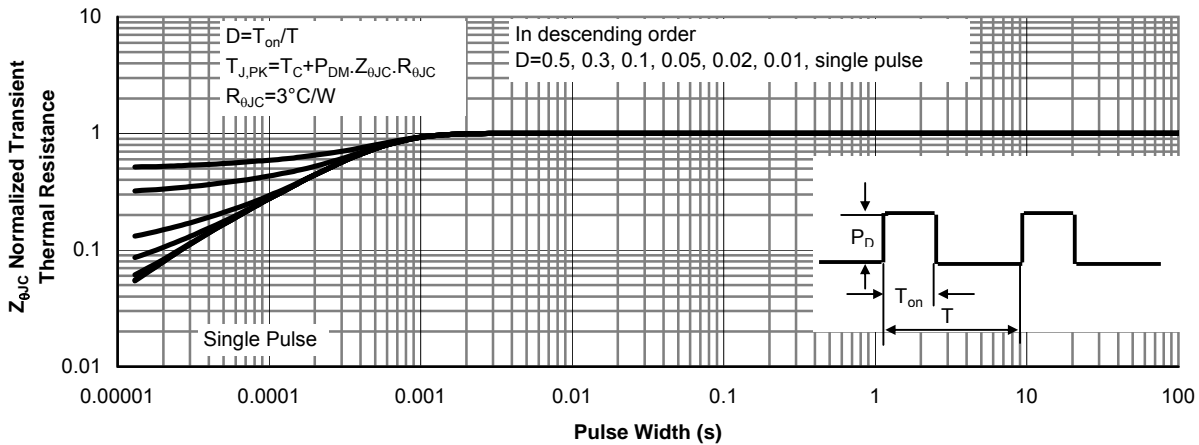

Figure 11: Normalized Maximum Transient Thermal Impedance (Note F)

TYPICAL ELECTRICAL AND THERMAL CHARACTERISTICS

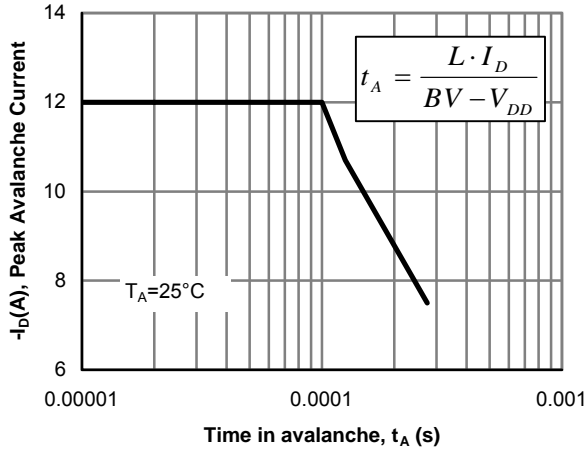

Figure 12: Single Pulse Avalanche capability

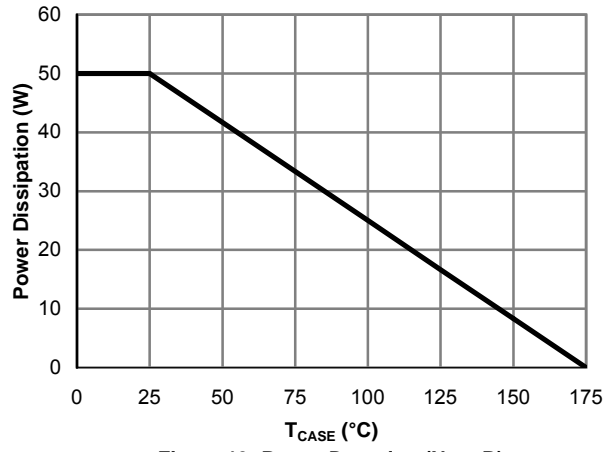

Figure 13: Power De-rating (Note B)

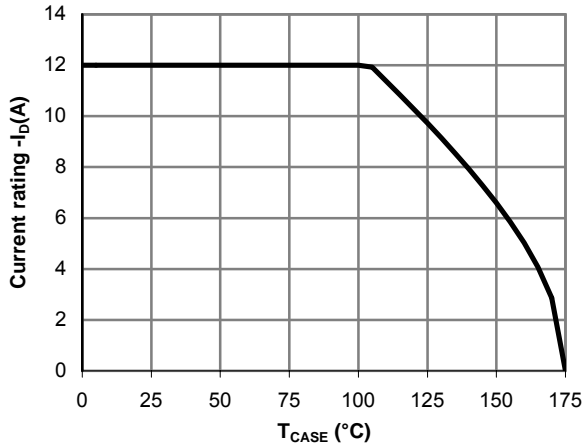

Figure 14: Current De-rating (Note B)

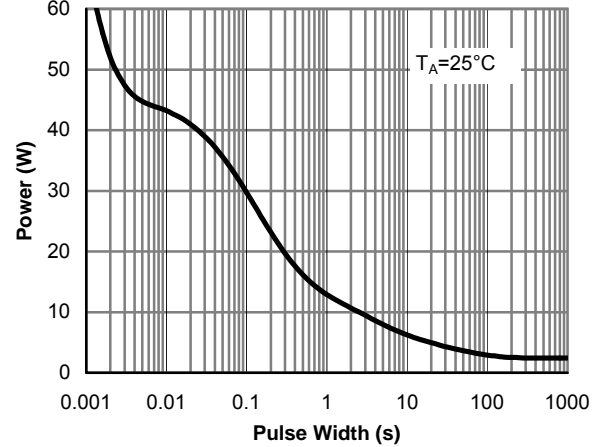

Figure 15: Single Pulse Power Rating Junction-to-Ambient (Note H)

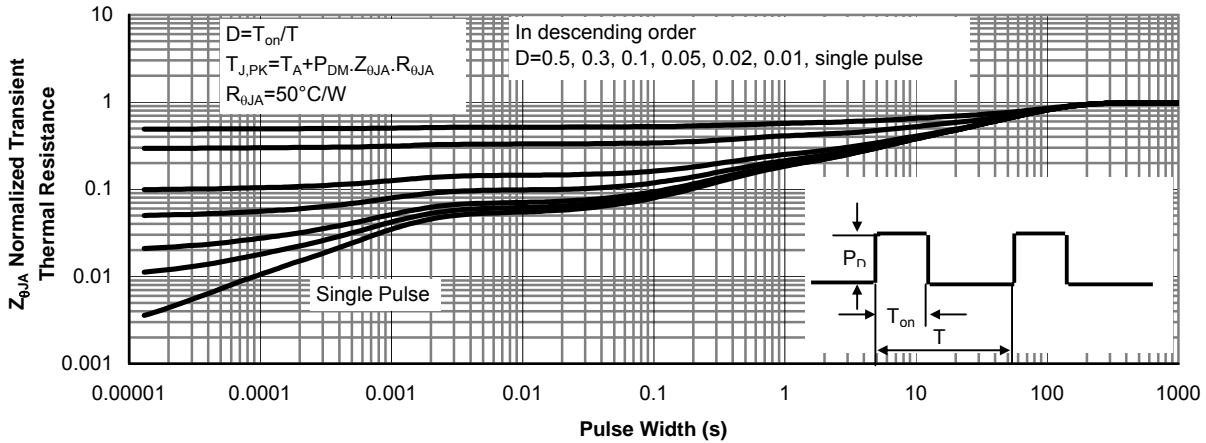
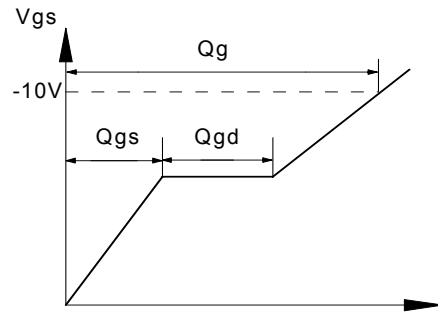
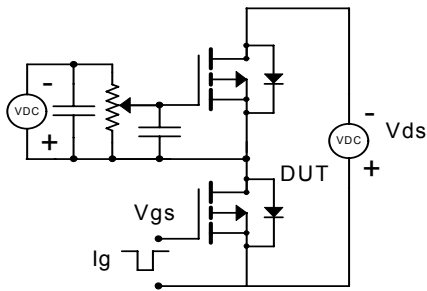
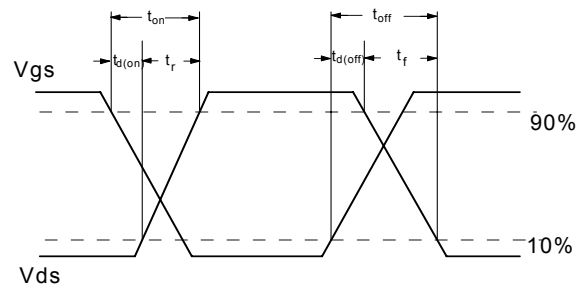
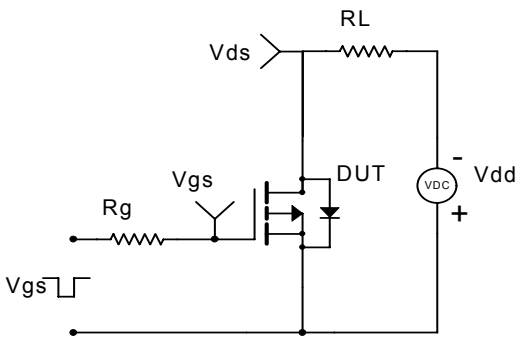

Figure 16: Normalized Maximum Transient Thermal Impedance (Note H)

Gate Charge Test Circuit & Waveform



Resistive Switching Test Circuit & Waveforms



Unclamped Inductive Switching (UIS) Test Circuit & Waveforms

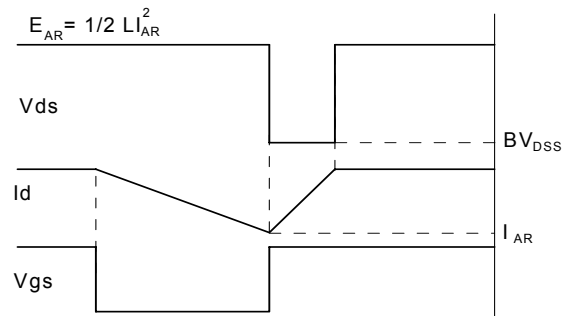
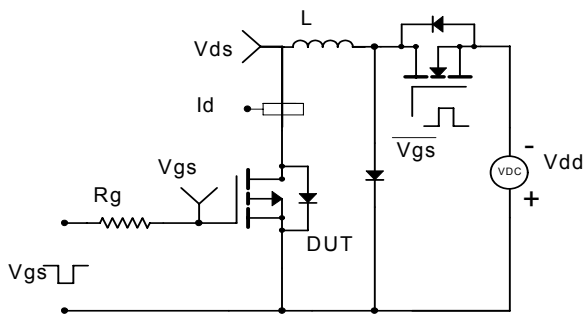

Diode Recovery Test Circuit & Waveforms

