

IRF3007SPbF

IRF3007LPbF

HEXFET® Power MOSFET

Typical Applications

- Industrial Motor Drive

Features

- Ultra Low On-Resistance
- 175°C Operating Temperature
- Fast Switching
- Repetitive Avalanche Allowed up to T_{jmax}
- Lead-Free

Description

This design of HEXFET® Power MOSFETs utilizes the latest processing techniques to achieve extremely low on-resistance per silicon area. Additional features of this HEXFET power MOSFET are a 175°C junction operating temperature, fast switching speed and improved repetitive avalanche rating. These combine to make this design an extremely efficient and reliable device for use in a wide variety of applications.

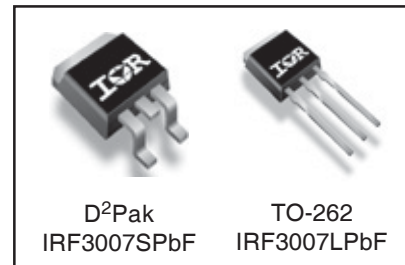
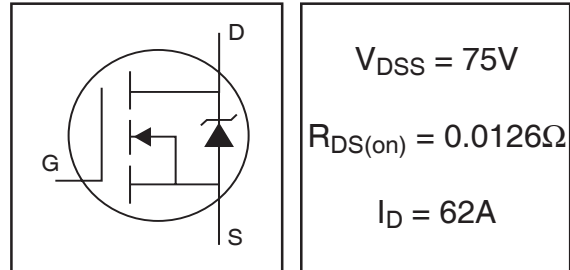

Absolute Maximum Ratings

| | Parameter | Max. | Units |
|----------------------------|--|--------------------------|-------|
| $I_D @ T_C = 25^\circ C$ | Continuous Drain Current, $V_{GS} @ 10V$ | 62 | A |
| $I_D @ T_C = 100^\circ C$ | Continuous Drain Current, $V_{GS} @ 10V$ | 44 | |
| I_{DM} | Pulsed Drain Current ① | 320 | |
| $P_D @ T_C = 25^\circ C$ | Power Dissipation | 120 | W |
| | Linear Derating Factor | 0.8 | W/°C |
| V_{GS} | Gate-to-Source Voltage | ± 20 | V |
| E_{AS} | Single Pulse Avalanche Energy ② | 290 | mJ |
| $E_{AS} (6 \text{ sigma})$ | Single Pulse Avalanche Energy Tested Value ③ | 946 | |
| I_{AR} | Avalanche Current ④ | See Fig.12a, 12b, 15, 16 | A |
| E_{AR} | Repetitive Avalanche Energy ⑤ | | mJ |
| T_J | Operating Junction and | -55 to + 175 | °C |
| T_{STG} | Storage Temperature Range | | |
| | Soldering Temperature, for 10 seconds | 300 (1.6mm from case) | |

Thermal Resistance

| | Parameter | Typ. | Max. | Units |
|-----------------|---|------|------|-------|
| $R_{\theta JC}$ | Junction-to-Case | — | 1.25 | °C/W |
| $R_{\theta JA}$ | Junction-to-Ambient (PCB Mounted, steady state)** | — | 62 | |

** This is applied to D²Pak, when mounted on 1" square PCB (FR-4 or G-10 Material).
 For recommended footprint and soldering techniques refer to application note #AN-994.

www.irf.com

1

07/23/10

Electrical Characteristics @ T_J = 25°C (unless otherwise specified)

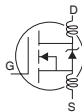
| | Parameter | Min. | Typ. | Max. | Units | Conditions |
|--------------------------------------|--------------------------------------|------|-------|------|-------|--|
| V _{(BR)DSS} | Drain-to-Source Breakdown Voltage | 75 | — | — | V | V _{GS} = 0V, I _D = 250μA |
| ΔV _{(BR)DSS/ΔT_J} | Breakdown Voltage Temp. Coefficient | — | 0.084 | — | V/°C | Reference to 25°C, I _D = 1mA |
| R _{DS(on)} | Static Drain-to-Source On-Resistance | — | 10.5 | 12.6 | mΩ | V _{GS} = 10V, I _D = 48A ④ |
| V _{GS(th)} | Gate Threshold Voltage | 2.0 | — | 4.0 | V | V _{DS} = 10V, I _D = 250μA |
| g _{fs} | Forward Transconductance | 180 | — | — | S | V _{DS} = 25V, I _D = 48A |
| I _{DSS} | Drain-to-Source Leakage Current | — | — | 20 | μA | V _{DS} = 75V, V _{GS} = 0V |
| | | — | — | 250 | | V _{DS} = 60V, V _{GS} = 0V, T _J = 150°C |
| I _{GSS} | Gate-to-Source Forward Leakage | — | — | 200 | nA | V _{GS} = 20V |
| | Gate-to-Source Reverse Leakage | — | — | -200 | | V _{GS} = -20V |
| Q _g | Total Gate Charge | — | 89 | 130 | nC | I _D = 48A |
| Q _{gs} | Gate-to-Source Charge | — | 21 | 32 | | V _{DS} = 60V |
| Q _{gd} | Gate-to-Drain ("Miller") Charge | — | 30 | 45 | | V _{GS} = 10V |
| t _{d(on)} | Turn-On Delay Time | — | 12 | — | ns | V _{DD} = 38V |
| t _r | Rise Time | — | 80 | — | | I _D = 48A |
| t _{d(off)} | Turn-Off Delay Time | — | 55 | — | | R _G = 4.6Ω |
| t _f | Fall Time | — | 49 | — | | V _{GS} = 10V ④ |
| L _D | Internal Drain Inductance | — | 4.5 | — | nH | Between lead, 6mm (0.25in.) from package and center of die contact |
| L _S | Internal Source Inductance | — | 7.5 | — | |  |
| C _{iss} | Input Capacitance | — | 3270 | — | pF | V _{GS} = 0V |
| C _{oss} | Output Capacitance | — | 520 | — | | V _{DS} = 25V |
| C _{rss} | Reverse Transfer Capacitance | — | 78 | — | | f = 1.0MHz, See Fig. 5 |
| C _{oss} | Output Capacitance | — | 3500 | — | | V _{GS} = 0V, V _{DS} = 1.0V, f = 1.0MHz |
| C _{oss} | Output Capacitance | — | 340 | — | | V _{GS} = 0V, V _{DS} = 60V, f = 1.0MHz |
| C _{oss eff.} | Effective Output Capacitance ⑤ | — | 640 | — | | V _{GS} = 0V, V _{DS} = 0V to 60V |

Source-Drain Ratings and Characteristics

| | Parameter | Min. | Typ. | Max. | Units | Conditions |
|-----------------|---|--|------|------|-------|---|
| I _S | Continuous Source Current (Body Diode) | — | — | 80⑥ | A | MOSFET symbol showing the integral reverse p-n junction diode. |
| I _{SM} | Pulsed Source Current (Body Diode) ① | — | — | 320 | | |
| V _{SD} | Diode Forward Voltage | — | — | 1.3 | V | T _J = 25°C, I _S = 48A, V _{GS} = 0V ④ |
| t _{rr} | Reverse Recovery Time | — | 85 | 130 | ns | T _J = 25°C, I _F = 48A, V _{DD} = 38V |
| Q _{rr} | Reverse Recovery Charge | — | 280 | 420 | nC | di/dt = 100A/μs ④ |
| t _{on} | Forward Turn-On Time | Intrinsic turn-on time is negligible (turn-on is dominated by L _S +L _D) | | | | |

Notes:

- ① Repetitive rating; pulse width limited by max. junction temperature. (See fig. 11).
- ② Starting T_J = 25°C, L = 0.24mH
R_G = 25Ω, I_{AS} = 48A, V_{GS} = 10V (See Figure 12).
- ③ I_{SD} ≤ 48A, di/dt ≤ 330A/μs, V_{DD} ≤ V_{(BR)DSS}, T_J ≤ 175°C
- ④ Pulse width ≤ 400μs; duty cycle ≤ 2%.
- ⑤ C_{oss eff.} is a fixed capacitance that gives the same charging time as C_{oss} while V_{DS} is rising from 0 to 80% V_{DSS}.
- ⑥ Limited by T_{Jmax}, see Fig.12a, 12b, 15, 16 for typical repetitive avalanche performance.
- ⑦ This value determined from sample failure population. 100% tested to this value in production.

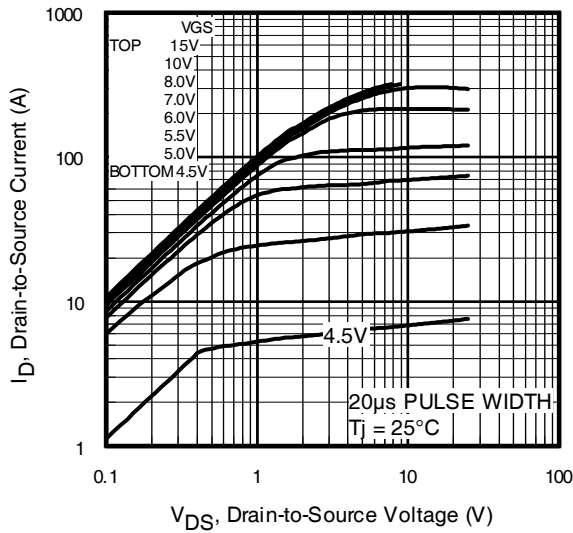

Fig 1. Typical Output Characteristics

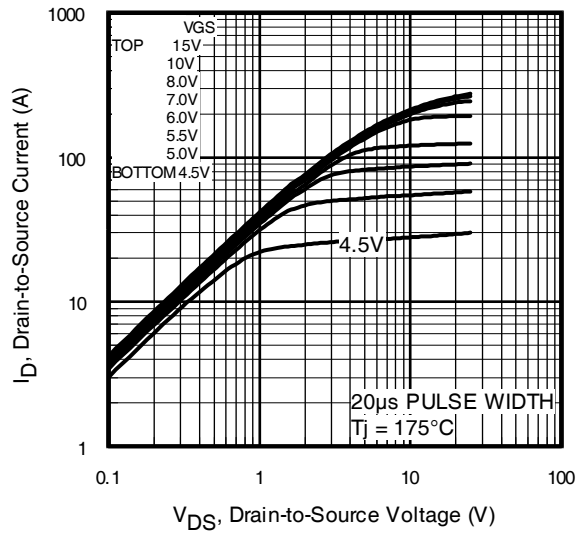

Fig 2. Typical Output Characteristics

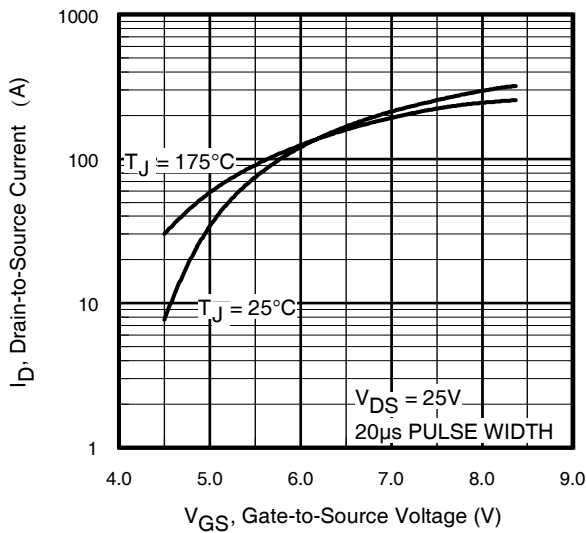

Fig 3. Typical Transfer Characteristics

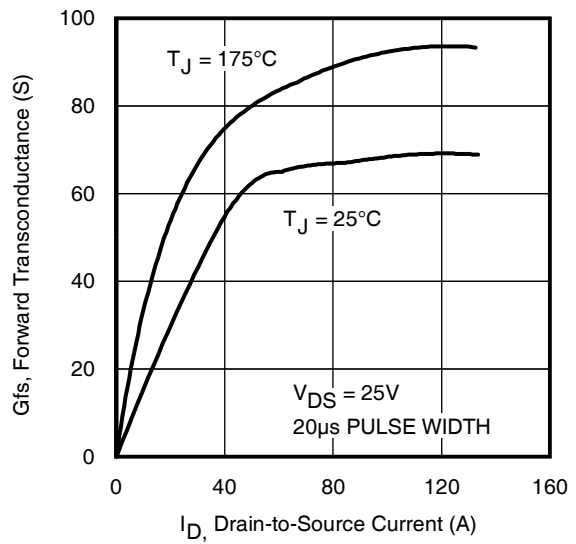

Fig 4. Typical Forward Transconductance Vs. Drain Current

IRF3007S/LPbF

International
IR Rectifier

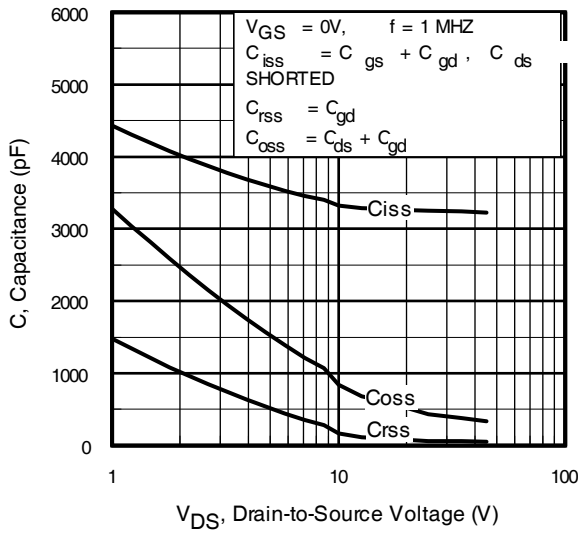

Fig 5. Typical Capacitance Vs. Drain-to-Source Voltage

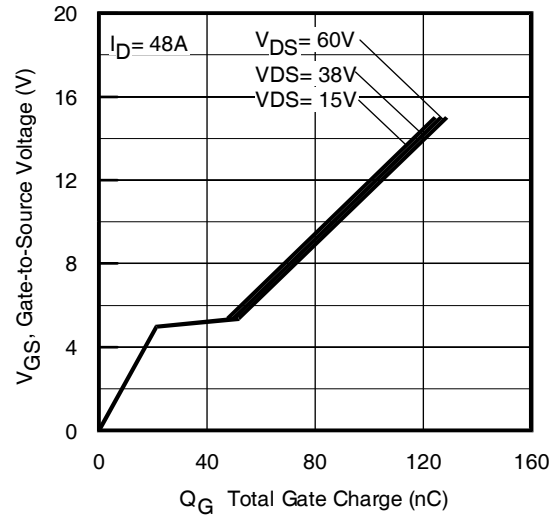

Fig 6. Typical Gate Charge Vs. Gate-to-Source Voltage

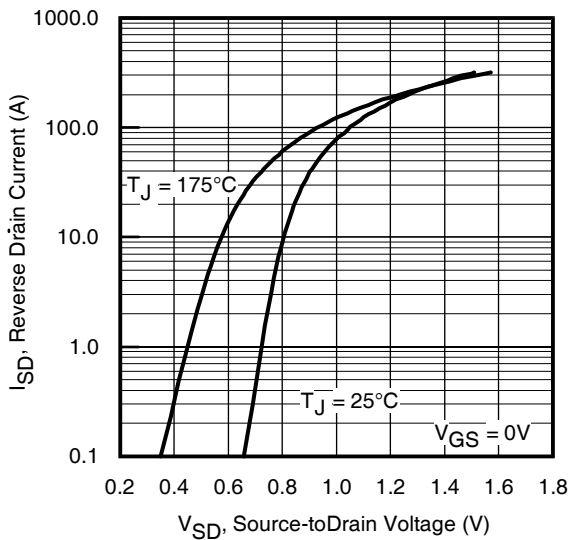

Fig 7. Typical Source-Drain Diode Forward Voltage

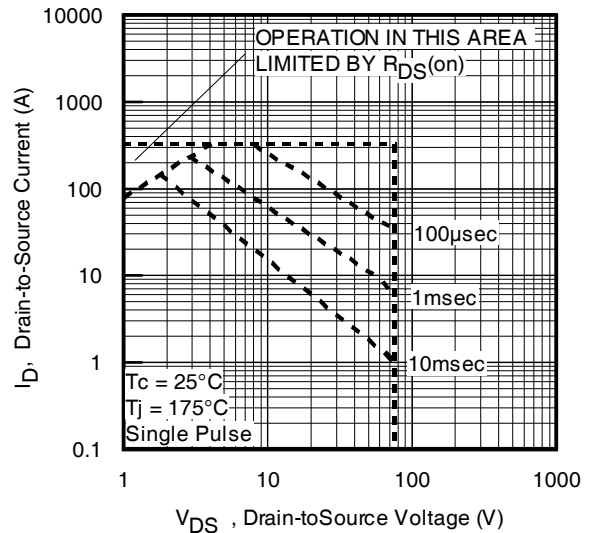

Fig 8. Maximum Safe Operating Area

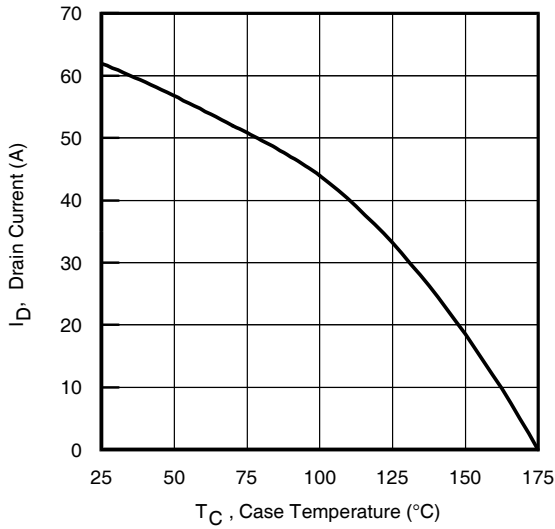

Fig 9. Maximum Drain Current Vs. Case Temperature

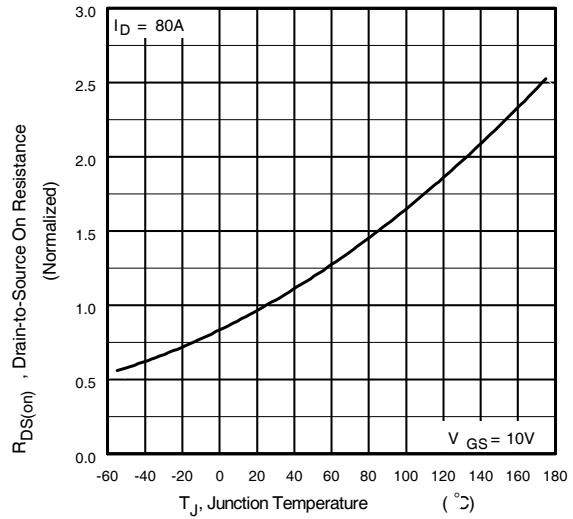

Fig 10. Normalized On-Resistance Vs. Temperature

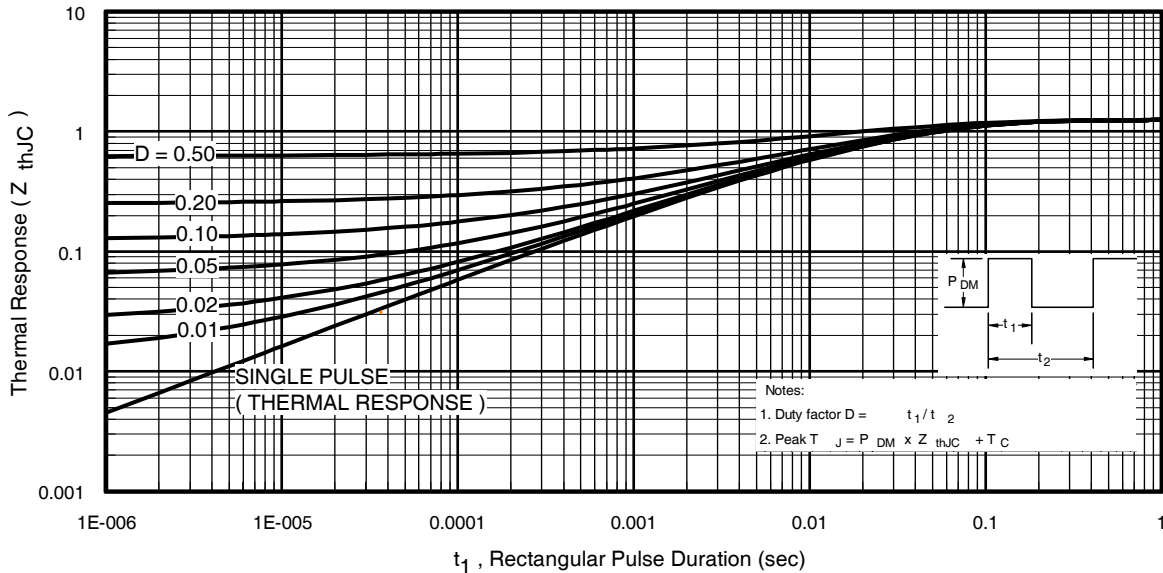

Fig 11. Maximum Effective Transient Thermal Impedance, Junction-to-Case

IRF3007S/LPbF

International
IR Rectifier

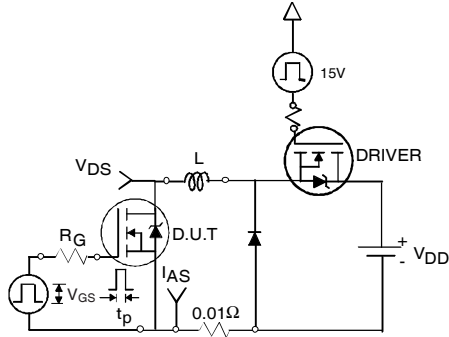

Fig 12a. Unclamped Inductive Test Circuit



Fig 12b. Unclamped Inductive Waveforms



Fig 13a. Basic Gate Charge Waveform



Fig 13b. Gate Charge Test Circuit

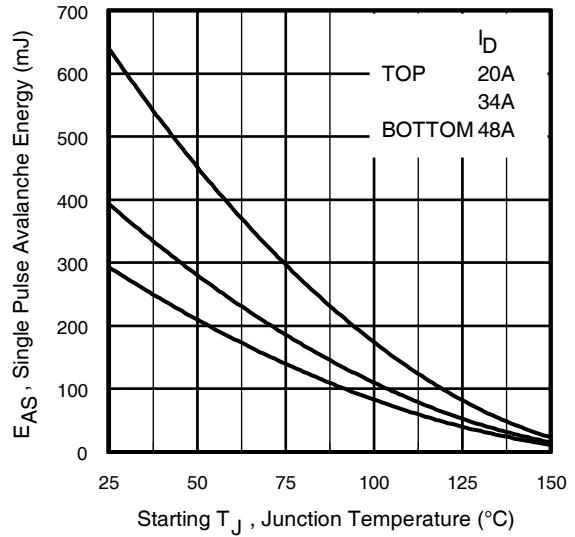

Fig 12c. Maximum Avalanche Energy Vs. Drain Current

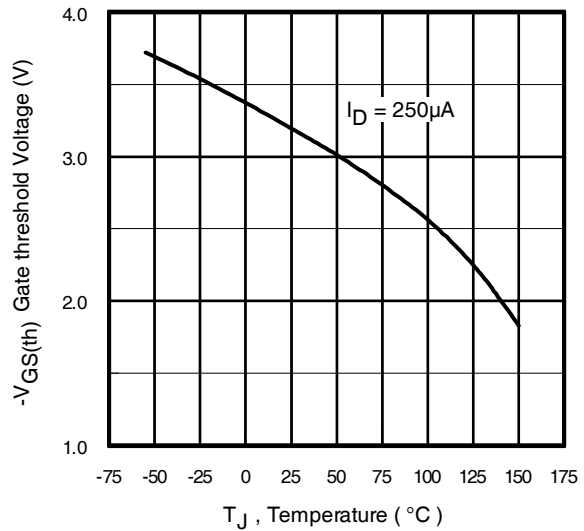

Fig 14. Threshold Voltage Vs. Temperature

www.irf.com

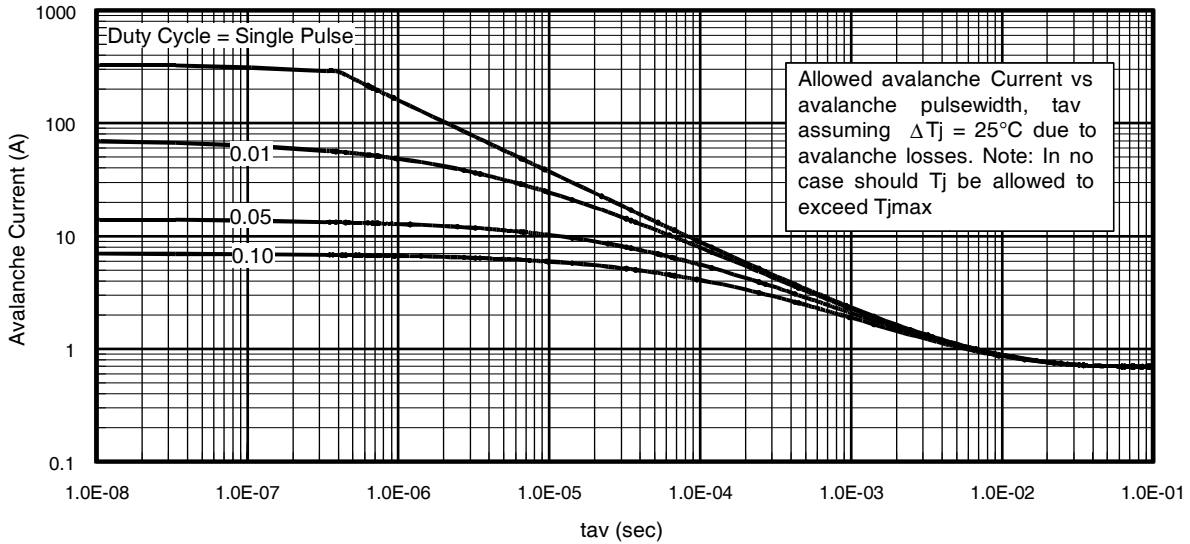

Fig 15. Typical Avalanche Current Vs.Pulsewidth

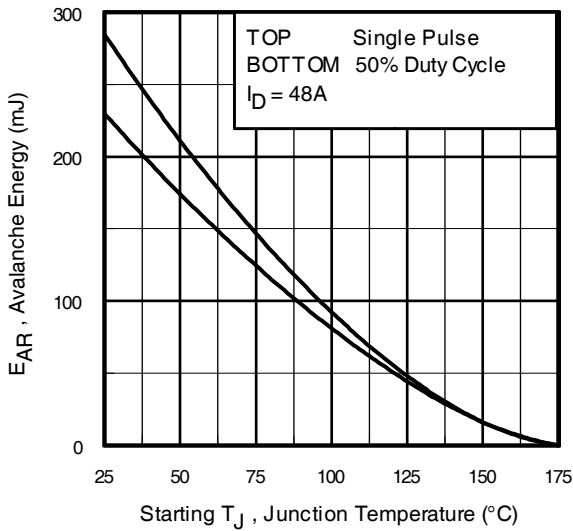

Fig 16. Maximum Avalanche Energy Vs. Temperature

Notes on Repetitive Avalanche Curves , Figures 15, 16:
(For further info, see AN-1005 at www.irf.com)

1. Avalanche failures assumption:
Purely a thermal phenomenon and failure occurs at a temperature far in excess of T_{jmax} . This is validated for every part type.
2. Safe operation in Avalanche is allowed as long as T_{jmax} is not exceeded.
3. Equation below based on circuit and waveforms shown in Figures 12a, 12b.
4. $P_{D(ave)}$ = Average power dissipation per single avalanche pulse.
5. BV = Rated breakdown voltage (1.3 factor accounts for voltage increase during avalanche).
6. I_{av} = Allowable avalanche current.
7. ΔT = Allowable rise in junction temperature, not to exceed T_{jmax} (assumed as 25°C in Figure 15, 16).
 t_{av} = Average time in avalanche.
 D = Duty cycle in avalanche = $t_{av} \cdot f$
 $Z_{thJC}(D, t_{av})$ = Transient thermal resistance, see figure 11)

$$P_{D(ave)} = 1/2 (1.3 \cdot BV \cdot I_{av}) = \Delta T / Z_{thJC}$$

$$I_{av} = 2\Delta T / [1.3 \cdot BV \cdot Z_{th}]$$

$$E_{AS(AR)} = P_{D(ave)} \cdot t_{av}$$

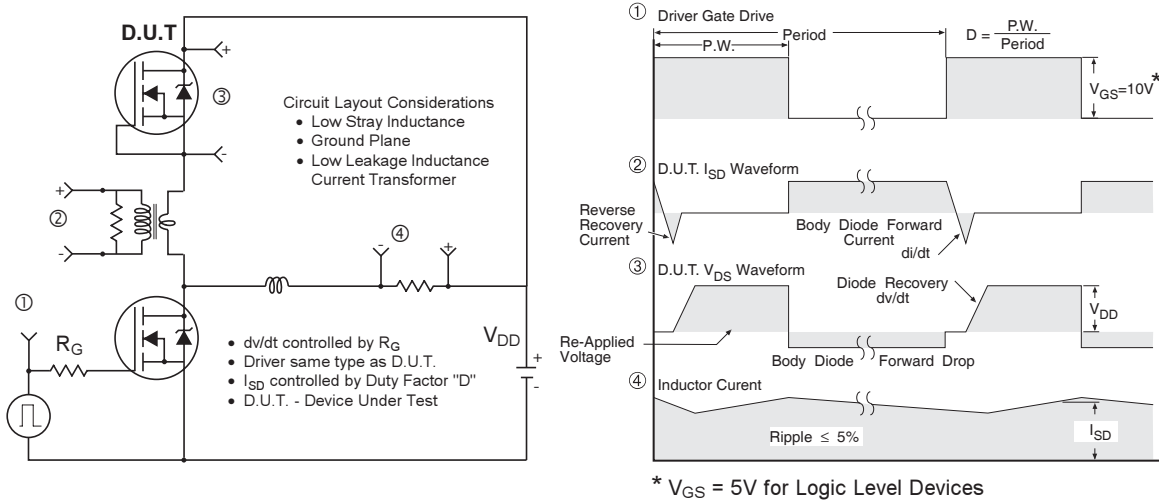

Fig 17. Peak Diode Recovery dv/dt Test Circuit for N-Channel HEXFET® Power MOSFETs

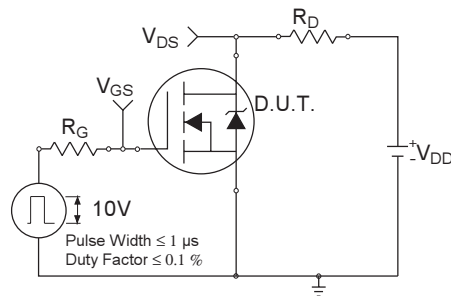

Fig 18a. Switching Time Test Circuit

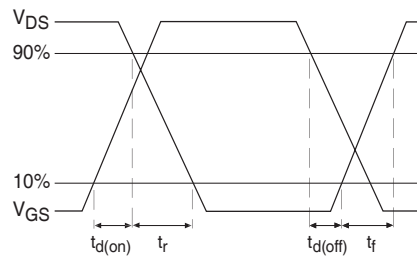
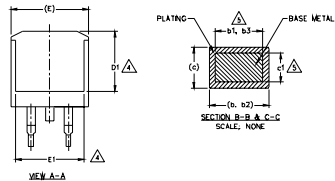
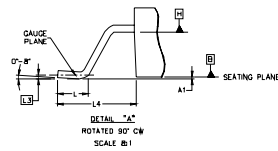
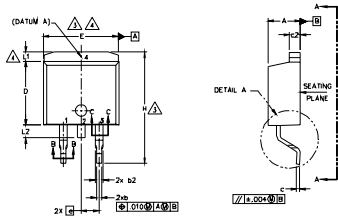

Fig 18b. Switching Time Waveforms

International
IR Rectifier
D²Pak (TO-263AB) Package Outline
 Dimensions are shown in millimeters (inches)

IRF3007S/LPbF



| SYMBOL | DIMENSIONS | | | | NOTES |
|--------|-------------|-------|----------|------|-------|
| | MILLIMETERS | | INCHES | | |
| | MIN. | MAX. | MIN. | MAX. | |
| A | 4.06 | 4.83 | .160 | .190 | |
| A1 | 0.00 | 0.254 | .000 | .010 | |
| b | 0.51 | 0.99 | .020 | .039 | 5 |
| b1 | 0.51 | 0.89 | .020 | .035 | |
| b2 | 1.14 | 1.78 | .045 | .070 | |
| b3 | 1.14 | 1.73 | .045 | .068 | 5 |
| c | 0.38 | 0.74 | .015 | .029 | |
| c1 | 0.38 | 0.58 | .015 | .023 | 5 |
| c2 | 1.14 | 1.65 | .045 | .065 | |
| D | 8.38 | 9.65 | .330 | .380 | 3 |
| D1 | 6.86 | - | .270 | - | 4 |
| E | 9.65 | 10.67 | .380 | .420 | 3,4 |
| E1 | 6.22 | - | .245 | - | 4 |
| e | 2.54 BSC | | .100 BSC | | |
| H | 14.61 | 15.88 | .575 | .625 | |
| L | 1.78 | 2.79 | .070 | .110 | |
| L1 | - | 1.65 | - | .066 | 4 |
| L2 | - | 1.78 | - | .070 | |
| L3 | 0.25 BSC | | .010 BSC | | |
| L4 | 4.78 | 5.28 | .188 | .208 | |

- NOTES:
1. DIMENSIONING AND TOLERANCING PER ASME Y14.5M-1994
 2. DIMENSIONS ARE SHOWN IN MILLIMETERS [INCHES].
 3. DIMENSION D & E DO NOT INCLUDE MOLD FLASH. MOLD FLASH SHALL NOT EXCEED 0.127 [0.005] PER SIDE. THESE DIMENSIONS ARE MEASURED AT THE OUTMOST EXTREMES OF THE PLASTIC BODY AT DATUM H.
 4. THERMAL PAD CONTOUR OPTIONAL WITHIN DIMENSION E, L1, D1 & E1.
 5. DIMENSION b1 AND c1 APPLY TO BASE METAL ONLY.
 6. DATUM A & B TO BE DETERMINED AT DATUM PLANE H.
 7. CONTROLLING DIMENSION: INCH.
 8. OUTLINE CONFORMS TO JEDEC OUTLINE TO-263AB.

D²Pak (TO-263AB) Part Marking Information

EXAMPLE: THIS IS AN IRF530S WITH
 LOT CODE 8024
 ASSEMBLED ON WW 02, 2000
 IN THE ASSEMBLY LINE "L"

Note: "P" in assembly line position
 indicates "Lead - Free"

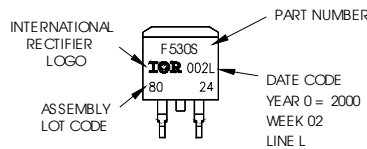

OR

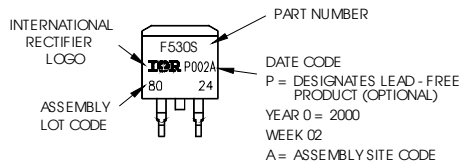

Notes:

1. For an Automotive Qualified version of this part please see <http://www.irf.com/product-info/auto/>
 2. For the most current drawing please refer to IR website at <http://www.irf.com/package/>
- www.irf.com

IRF3007S/LPbF

TO-262 Package Outline

Dimensions are shown in millimeters (inches)

International
IR Rectifier

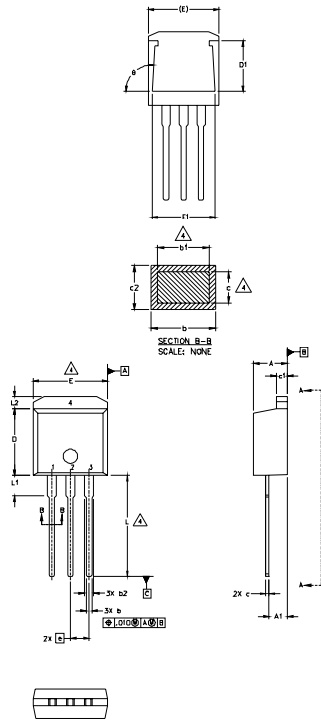

| SYMBOL | DIMENSIONS | | | | NOTES |
|--------|-------------|-------|----------|------|-------|
| | MILLIMETERS | | INCHES | | |
| | MIN. | MAX. | MIN. | MAX. | |
| A | 4.06 | 4.83 | .160 | .190 | |
| A1 | 2.03 | 2.92 | .080 | .115 | |
| b | 0.51 | 0.99 | .020 | .039 | |
| b1 | 0.51 | 0.89 | .020 | .035 | 4 |
| b2 | 1.14 | 1.40 | .045 | .055 | |
| c | 0.38 | 0.63 | .015 | .025 | 4 |
| c1 | 1.14 | 1.40 | .045 | .055 | |
| c2 | 0.43 | .063 | .017 | .029 | |
| D | 8.51 | 9.65 | .335 | .380 | 3 |
| D1 | 5.33 | | .210 | | |
| E | 9.65 | 10.67 | .380 | .420 | 3 |
| E1 | 6.22 | | .245 | | |
| e | 2.54 BSC | | .100 BSC | | |
| L | 13.46 | 14.09 | .530 | .555 | |
| L1 | 3.56 | 3.71 | .140 | .146 | |
| L2 | | 1.65 | | .065 | |

LEAD ASSIGNMENTS

HEXFET

- 1.- GATE
- 2.- DRAIN
- 3.- SOURCE
- 4.- DRAIN

IGBT

- 1 - GATE
- 2 - COLLECTOR
- 3 - EMITTER

ES-

DIMENSIONING AND TOLERANCING PER ASME Y14.6M-1994

DIMENSIONS ARE SHOWN IN MILLIMETERS [INCHES].

DIMENSION D & E DO NOT INCLUDE MOLD FLASH. MOLD FLASH SHALL NOT EXCEED 0.127 [0.005"] PER SIDE. THESE DIMENSIONS ARE MEASURED AT THE OUTMOST EXTREMES OF THE PLASTIC BODY.

DIMENSION b1 AND c1 APPLY TO BASE METAL ONLY.

5. CONTROLLING DIMENSION: INCH.

TO-262 Part Marking Information

EXAMPLE: THIS IS AN IRL3103L

LOT CODE 1789

ASSEMBLED ON WW 19, 1997
IN THE ASSEMBLY LINE "C"

Note: "P" in assembly line
position indicates "Lead-Free"

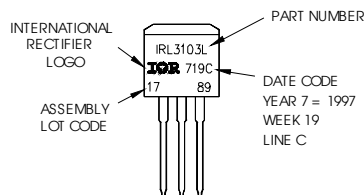

OR

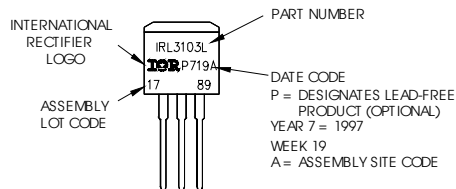

Notes:

1. For an Automotive Qualified version of this part please see <http://www.irf.com/product-info/autol>
2. For the most current drawing please refer to IR website at <http://www.irf.com/package/>

D²Pak Tape & Reel Information

Dimensions are shown in millimeters (inches)

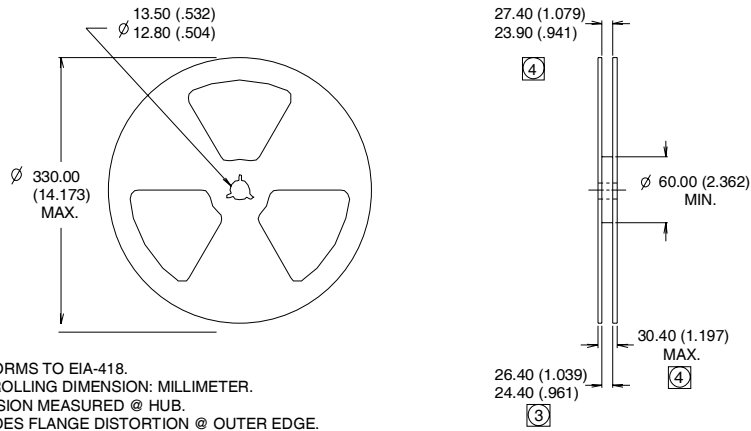
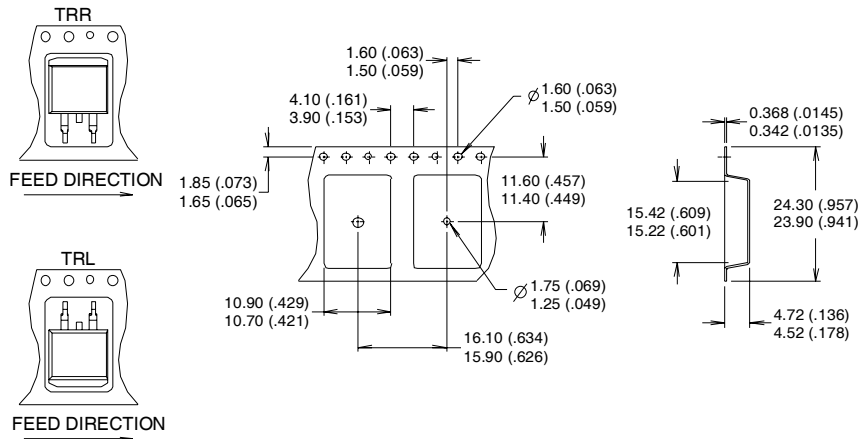

- NOTES :
1. COMFORMS TO EIA-418.
 2. CONTROLLING DIMENSION: MILLIMETER.
 - ③ DIMENSION MEASURED @ HUB.
 - ④ INCLUDES FLANGE DISTORTION @ OUTER EDGE.

Data and specifications subject to change without notice.
 This product has been designed and qualified for the Industrial market.
 Qualification Standards can be found on IR's Web site.