

Applications

- High Frequency DC-DC Isolated Converters with Synchronous Rectification for Telecom and Industrial use
- High Frequency Buck Converters for Computer Processor Power
- Lead-Free

HEXFET® Power MOSFET

V_{DSS}	R_{DS(on)} max	I_D
30V	12.5mΩ	62A

Benefits

- Ultra-Low Gate Impedance
- Very Low R_{DS(on)}
- Fully Characterized Avalanche Voltage and Current

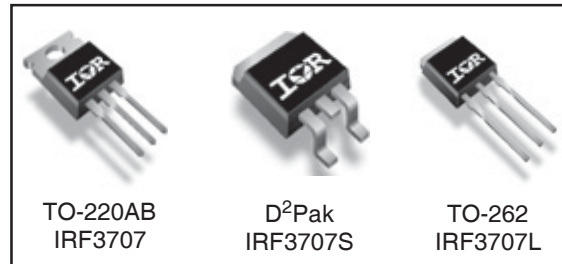

Absolute Maximum Ratings

Symbol	Parameter	Max.	Units
V _{DS}	Drain-Source Voltage	30	V
V _{GS}	Gate-to-Source Voltage	± 20	V
I _D @ T _C = 25°C	Continuous Drain Current, V _{GS} @ 10V	62	A
I _D @ T _C = 70°C	Continuous Drain Current, V _{GS} @ 10V	52	
I _{DM}	Pulsed Drain Current ^①	248	
P _D @ T _C = 25°C	Maximum Power Dissipation ^③	87	W
P _D @ T _C = 70°C	Maximum Power Dissipation ^③	61	W
	Linear Derating Factor	0.59	mW/°C
T _J , T _{STG}	Junction and Storage Temperature Range	-55 to + 175	°C

Thermal Resistance

	Parameter	Typ.	Max.	Units
R _{θJC}	Junction-to-Case	—	1.73	°C/W
R _{θCS}	Case-to-Sink, Flat, Greased Surface ^④	0.50	—	
R _{θJA}	Junction-to-Ambient ^④	—	62	
R _{θJA}	Junction-to-Ambient (PCB mount)*	—	40	

* When mounted on 1" square PCB (FR-4 or G-10 Material) .
For recommended footprint and soldering techniques refer to application note #AN-994

Notes ① through ④ are on page 10

www.irf.com

IRF3707S/LPbF

International
IR Rectifier

Static @ $T_J = 25^\circ\text{C}$ (unless otherwise specified)

	Parameter	Min.	Typ.	Max.	Units	Conditions
$V_{(BR)DSS}$	Drain-to-Source Breakdown Voltage	30	—	—	V	$V_{GS} = 0V, I_D = 250\mu A$
$\Delta V_{(BR)DSS}/\Delta T_J$	Breakdown Voltage Temp. Coefficient	—	0.027	—	V/°C	Reference to $25^\circ\text{C}, I_D = 1\text{mA}$
$R_{DS(on)}$	Static Drain-to-Source On-Resistance	—	9.0	12.5	m Ω	$V_{GS} = 10V, I_D = 15A$ ③
		—	12.6	17		$V_{GS} = 4.5V, I_D = 12A$ ③
$V_{GS(th)}$	Gate Threshold Voltage	1.0	—	3.0	V	$V_{DS} = V_{GS}, I_D = 250\mu A$
I_{DSS}	Drain-to-Source Leakage Current	—	—	20	μA	$V_{DS} = 24V, V_{GS} = 0V$
		—	—	100		$V_{DS} = 24V, V_{GS} = 0V, T_J = 125^\circ\text{C}$
I_{GSS}	Gate-to-Source Forward Leakage	—	—	200	nA	$V_{GS} = 16V$
	Gate-to-Source Reverse Leakage	—	—	-200		$V_{GS} = -16V$

Dynamic @ $T_J = 25^\circ\text{C}$ (unless otherwise specified)

Symbol	Parameter	Min.	Typ.	Max.	Units	Conditions
g_{fs}	Forward Transconductance	37	—	—	S	$V_{DS} = 15V, I_D = 49.6A$
Q_g	Total Gate Charge	—	19	—	nC	$I_D = 24.8A$
Q_{gs}	Gate-to-Source Charge	—	8.2	—		$V_{DS} = 15V$
Q_{gd}	Gate-to-Drain ("Miller") Charge	—	6.3	—		$V_{GS} = 4.5V$ ③
Q_{oss}	Output Gate Charge	—	18	27		$V_{GS} = 0V, V_{DS} = 15V$
$t_{d(on)}$	Turn-On Delay Time	—	8.5	—	ns	$V_{DD} = 15V$
t_r	Rise Time	—	78	—		$I_D = 24.8A$
$t_{d(off)}$	Turn-Off Delay Time	—	11.8	—		$R_G = 1.8\Omega$
t_f	Fall Time	—	3.3	—		$V_{GS} = 4.5V$ ③
C_{iss}	Input Capacitance	—	1990	—	pF	$V_{GS} = 0V$
C_{oss}	Output Capacitance	—	707	—		$V_{DS} = 15V$
C_{rss}	Reverse Transfer Capacitance	—	50	—		$f = 1.0\text{MHz}$

Avalanche Characteristics

Symbol	Parameter	Typ.	Max.	Units
E_{AS}	Single Pulse Avalanche Energy②	—	213	mJ
I_{AR}	Avalanche Current①	—	62	A

Diode Characteristics

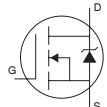
Symbol	Parameter	Min.	Typ.	Max.	Units	Conditions
I_S	Continuous Source Current (Body Diode)	—	—	62	A	MOSFET symbol showing the integral reverse p-n junction diode. 
I_{SM}	Pulsed Source Current (Body Diode) ①	—	—	248		
V_{SD}	Diode Forward Voltage	—	0.88	1.3	V	$T_J = 25^\circ\text{C}, I_S = 31A, V_{GS} = 0V$ ③
		—	0.8	—		$T_J = 125^\circ\text{C}, I_S = 31A, V_{GS} = 0V$ ③
t_{rr}	Reverse Recovery Time	—	39	59	ns	$T_J = 25^\circ\text{C}, I_F = 31A, V_R = 20V$
Q_{rr}	Reverse Recovery Charge	—	49	74	nC	$di/dt = 100A/\mu s$ ③
t_{rr}	Reverse Recovery Time	—	42	63	ns	$T_J = 125^\circ\text{C}, I_F = 31A, V_R = 20V$
Q_{rr}	Reverse Recovery Charge	—	62	93	nC	$di/dt = 100A/\mu s$ ③

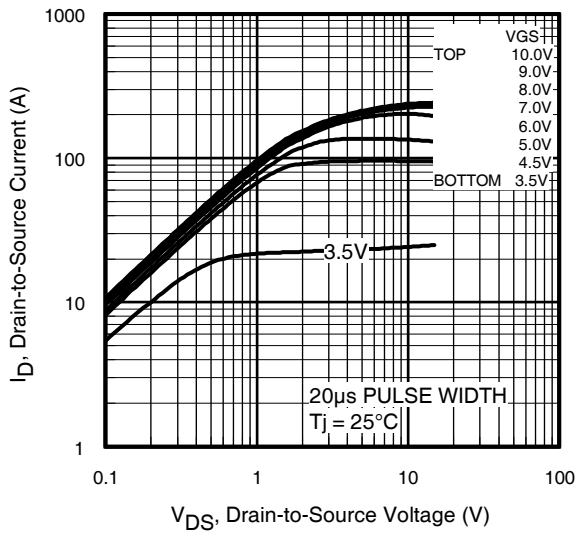

Fig 1. Typical Output Characteristics

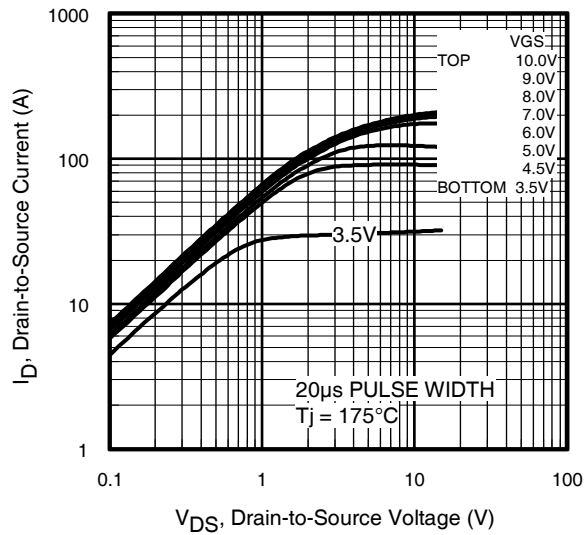

Fig 2. Typical Output Characteristics

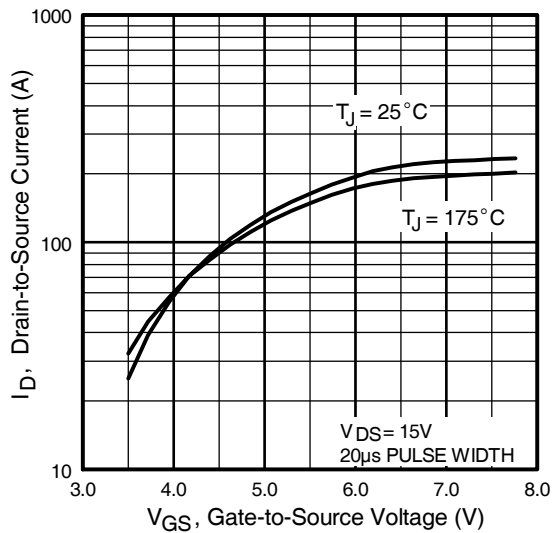

Fig 3. Typical Transfer Characteristics

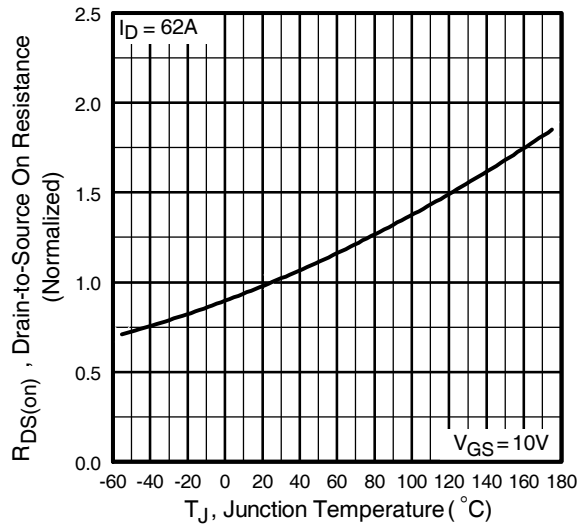

Fig 4. Normalized On-Resistance Vs. Temperature

IRF3707S/LPbF

International
IR Rectifier

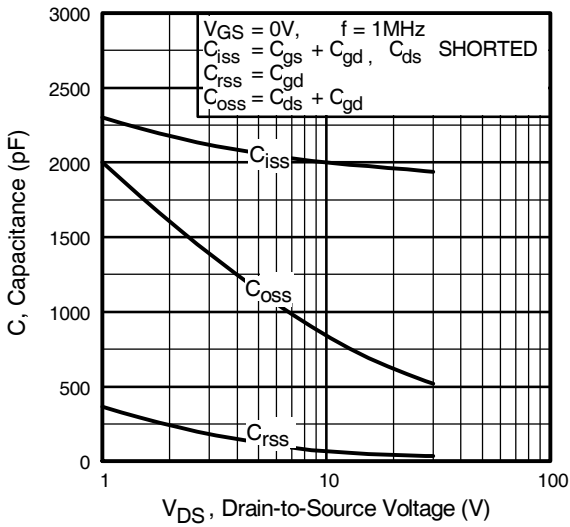

Fig 5. Typical Capacitance Vs. Drain-to-Source Voltage

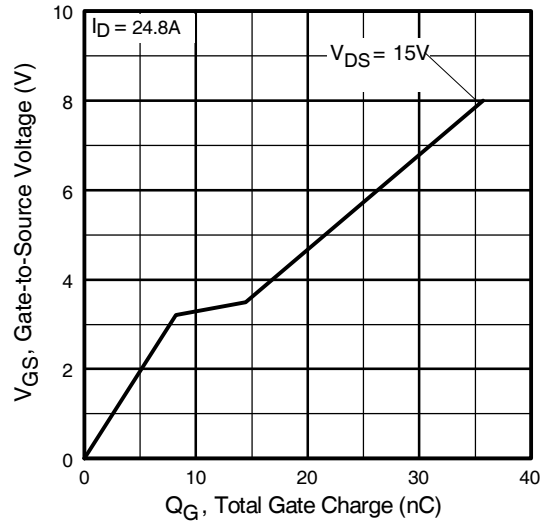

Fig 6. Typical Gate Charge Vs. Gate-to-Source Voltage

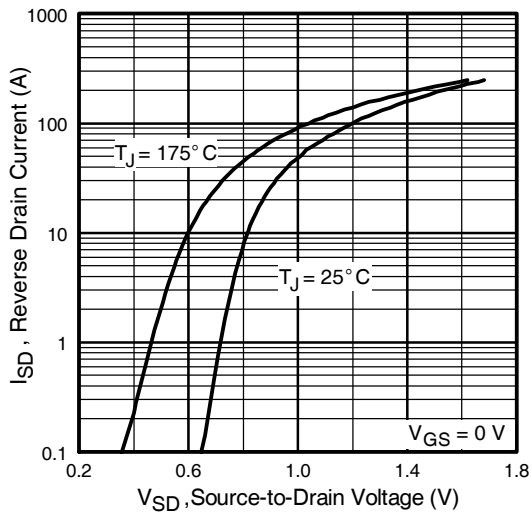

Fig 7. Typical Source-Drain Diode Forward Voltage

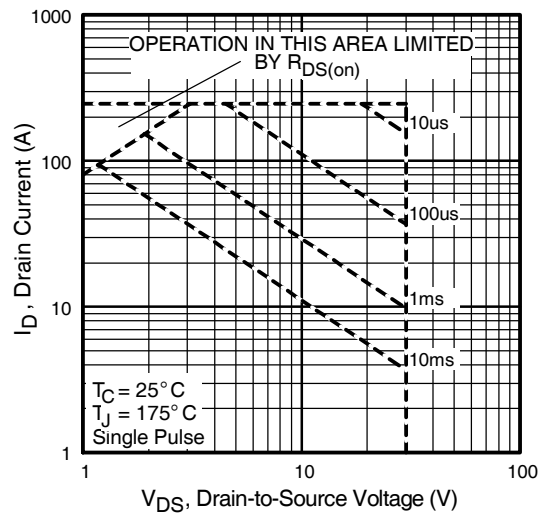

Fig 8. Maximum Safe Operating Area

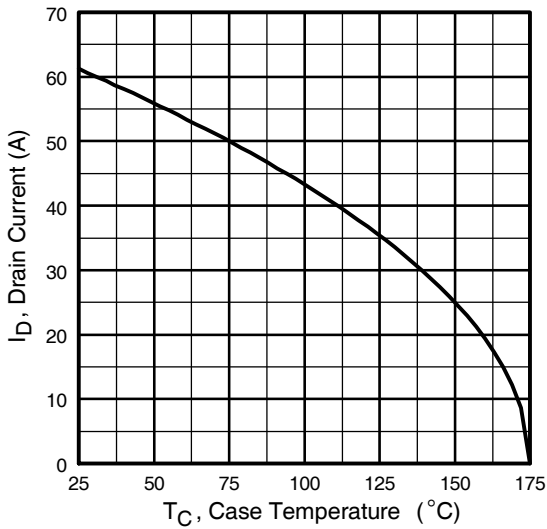

Fig 9. Maximum Drain Current Vs. Case Temperature

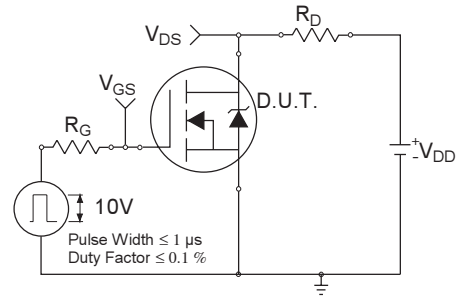

Fig 10a. Switching Time Test Circuit

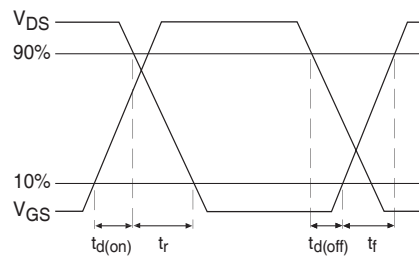

Fig 10b. Switching Time Waveforms

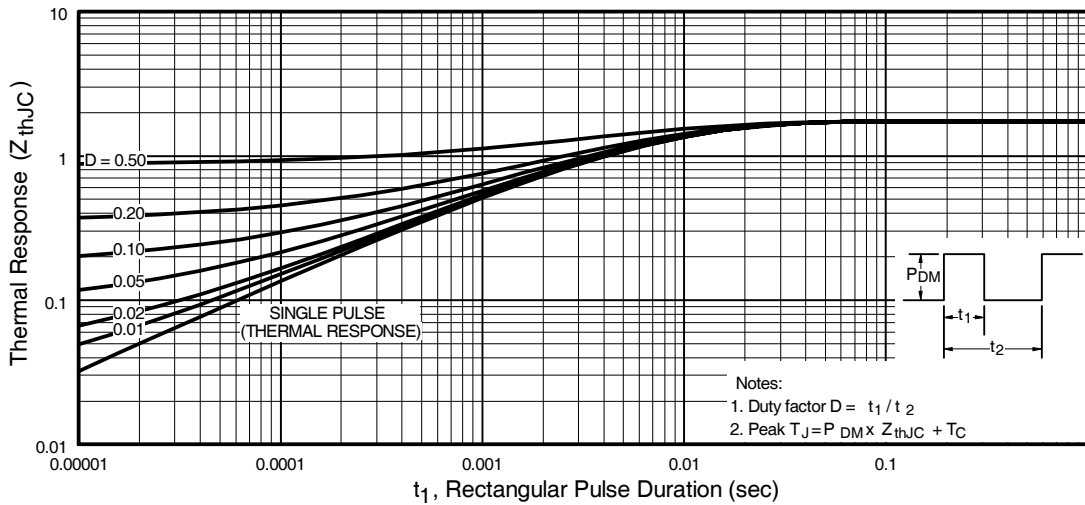

Fig 11. Maximum Effective Transient Thermal Impedance, Junction-to-Ambient

IRF3707S/LPbF

International
IR Rectifier

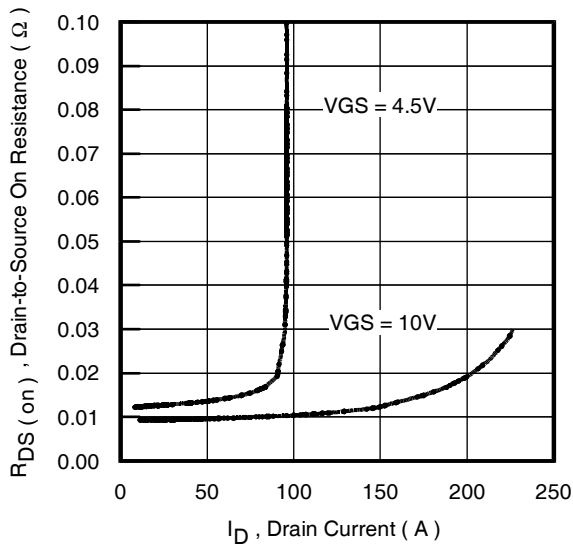

Fig 12. On-Resistance Vs. Drain Current

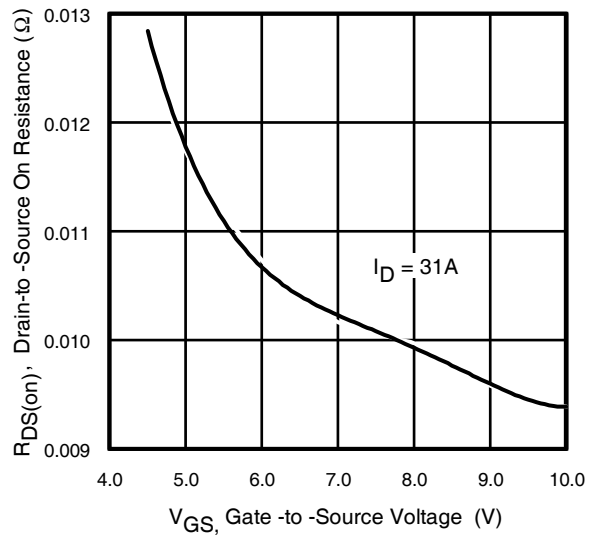

Fig 13. On-Resistance Vs. Gate Voltage

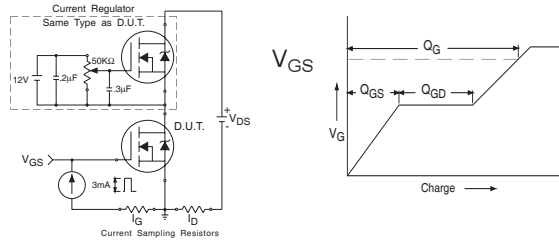

Fig 14a&b. Basic Gate Charge Test circuit and Waveforms

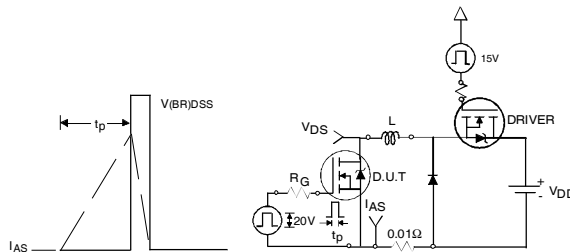

Fig 15a&b. Unclamped Inductive Test circuit and Waveforms

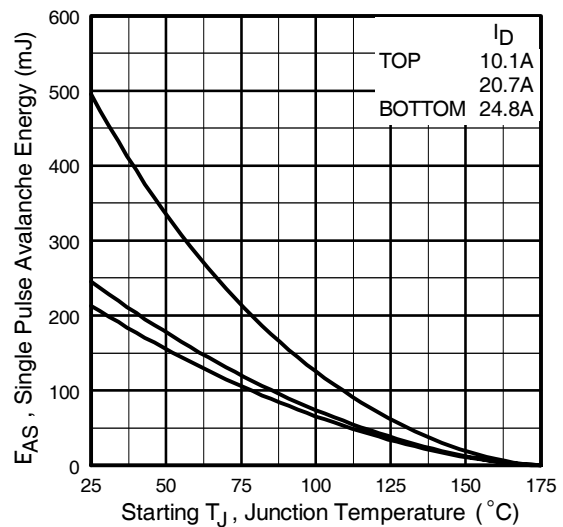
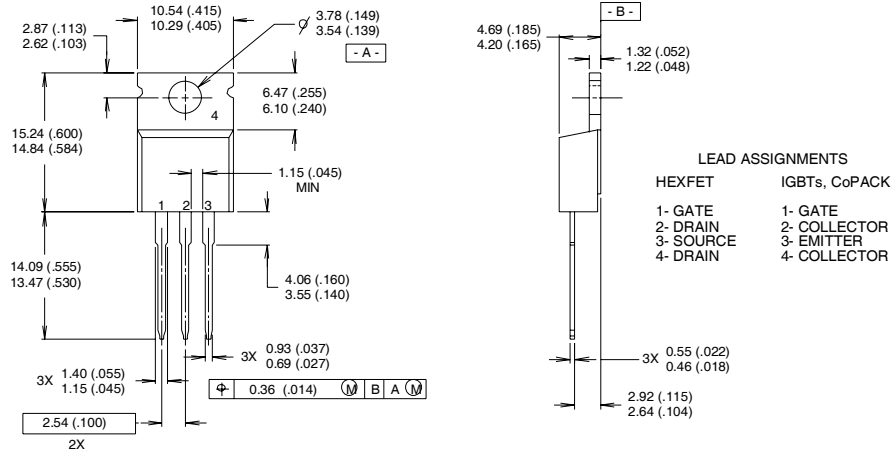

Fig 15c. Maximum Avalanche Energy Vs. Drain Current

TO-220AB Package Outline

Dimensions are shown in millimeters (inches)



- NOTES:
- 1 DIMENSIONING & TOLERANCING PER ANSI Y14.5M, 1982.
 - 2 CONTROLLING DIMENSION : INCH
 - 3 OUTLINE CONFORMS TO JEDEC OUTLINE TO-220AB.
 - 4 HEATSINK & LEAD MEASUREMENTS DO NOT INCLUDE BURRS.

TO-220AB Part Marking Information

EXAMPLE: THIS IS AN IRF1010
 LOT CODE 1789
 ASSEMBLED ON WW 19, 1997
 IN THE ASSEMBLY LINE "C"
Note: "P" in assembly line
 position indicates "Lead-Free"

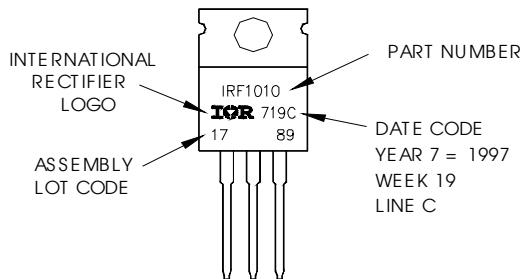

IRF3707S/LPbF

International
IR Rectifier

D²Pak Package Outline

Dimensions are shown in millimeters (inches)

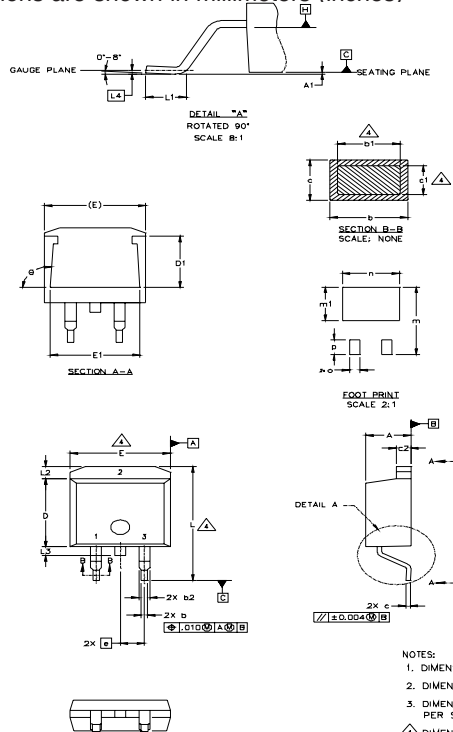

SYMBOL	DIMENSIONS				NOTES
	MILLIMETERS		INCHES		
	MIN.	MAX.	MIN.	MAX.	
A	4.06	4.83	.160	.190	4
A1		0.127	.005		
b	0.51	0.99	.020	.039	
b1	0.51	0.89	.020	.035	
b2	1.14	1.40	.045	.055	4
c	0.43	0.63	.017	.025	
c1	0.38	0.74	.015	.029	3
c2	1.14	1.40	.045	.055	
D	8.51	9.65	.335	.380	3
D1	5.33		.210		
E	9.65	10.67	.380	.420	
E1	6.22		.245		
e	2.54 BSC		.100 BSC		
L	14.61	15.88	.575	.625	
L1	1.78	2.79	.070	.110	
L2		1.65		.065	
L3	1.27	1.78	.050	.070	
L4	0.25 BSC		.010 BSC		
m	17.78		.700		
m1	8.89		.350		
n	11.43		.450		
o	2.08		.082		
p	3.81		.150		
θ	90°	93°	90°	93°	

LEAD ASSIGNMENTS

HEXFET	IGBTs, CoPACK	DIODES
1.- GATE	1.- GATE	1.- ANODE *
2.- DRAIN	2.- COLLECTOR	2.- CATHODE
3.- SOURCE	3.- EMITTER	3.- ANODE

* PART DEPENDENT.

NOTES:

1. DIMENSIONING AND TOLERANCING PER ASME Y14.5M-1994
2. DIMENSIONS ARE SHOWN IN MILLIMETERS [INCHES]
3. DIMENSION D & E DO NOT INCLUDE MOLD FLASH. MOLD FLASH SHALL NOT EXCEED 0.127 (.005") PER SIDE. THESE DIMENSIONS ARE MEASURED AT THE OUTMOST EXTREMES OF THE PLASTIC BODY.
4. DIMENSION b1 AND c1 APPLY TO BASE METAL ONLY.
5. CONTROLLING DIMENSION: INCH.

D²Pak Part Marking Information (Lead-Free)

EXAMPLE: THIS IS AN IRF530S WITH
LOT CODE 8024
ASSEMBLED ON WW 02, 2000
IN THE ASSEMBLY LINE "L"

Note: "P" in assembly line
position indicates "Lead-Free"

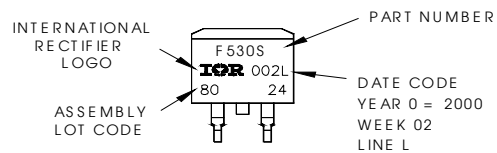

OR

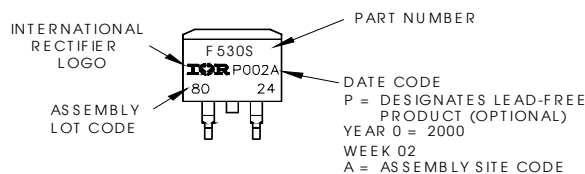

TO-262 Package Outline

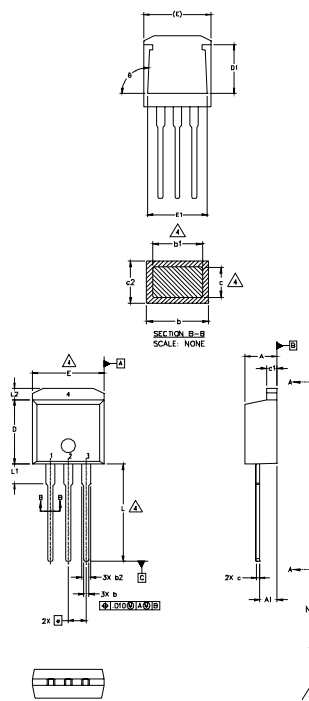

SYMBOL	DIMENSIONS				NOTES
	MILLIMETERS		INCHES		
	MIN.	MAX.	MIN.	MAX.	
A	4.06	4.83	.160	.190	4
A1	2.03	2.92	.080	.115	
b	0.51	0.99	.020	.039	
b1	0.51	0.89	.020	.035	
b2	1.14	1.40	.045	.055	4
c	0.38	0.63	.015	.025	
c1	1.14	1.40	.045	.055	
c2	0.43	.063	.017	.029	3
D	8.51	9.65	.335	.380	
D1	5.33		.210		3
E	9.65	10.67	.380	.420	
E1	6.22		.245		
e	2.54 BSC		.100 BSC		
L	13.46	14.09	.530	.555	
L1	3.56	3.71	.140	.146	
L2		1.65		.065	

LEAD ASSIGNMENTS

	IGBT
HEXFET	1- GATE
1.- GATE	2- COLLECTOR
2.- DRAIN	3- EMITTER
3.- SOURCE	
4.- DRAIN	

- NOTES:
1. DIMENSIONING AND TOLERANCING PER ASME Y14.5M-1994
 2. DIMENSIONS ARE SHOWN IN MILLIMETERS [INCHES].
 3. DIMENSION D & E DO NOT INCLUDE MOLD FLASH. MOLD FLASH SHALL NOT EXCEED 0.127 [0.005"] PER SIDE. THESE DIMENSIONS ARE MEASURED AT THE OUTMOST EXTREMES OF THE PLASTIC BODY.
 4. DIMENSION b1 AND c1 APPLY TO BASE METAL ONLY.
 5. CONTROLLING DIMENSION: INCH.

TO-262 Part Marking Information

EXAMPLE: THIS IS AN IRL3103L
LOT CODE 1789
ASSEMBLED ON WW 19, 1997
IN THE ASSEMBLY LINE "C"

Note: "P" in assembly line position indicates "Lead-Free"

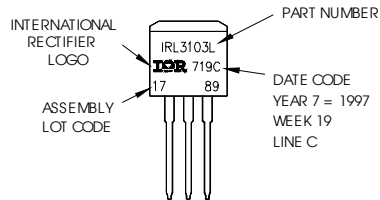

OR

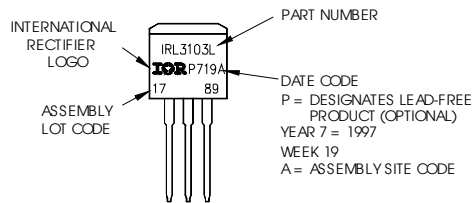

D²Pak Tape & Reel Information

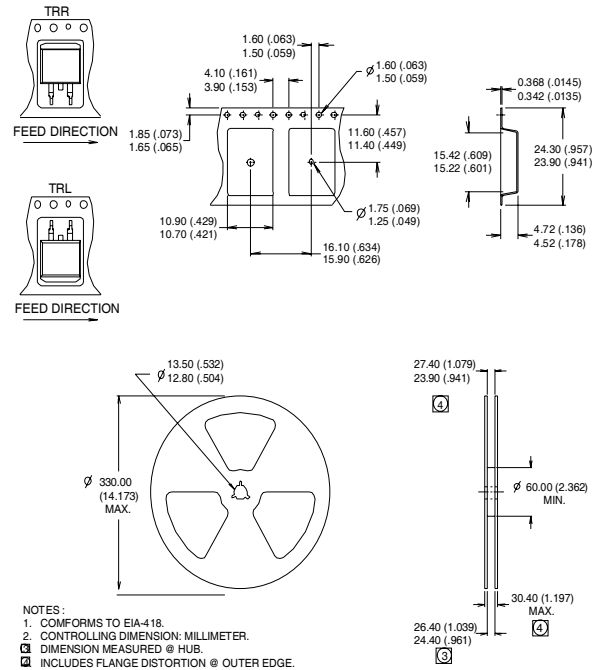

Notes:

- ① Repetitive rating; pulse width limited by max. junction temperature.
- ② Starting $T_J = 25^\circ\text{C}$, $L = 0.7 \text{ mH}$
 $R_G = 25\Omega$, $I_{AS} = 24.8 \text{ A}$.
- ③ Pulse width $\leq 300\mu\text{s}$; duty cycle $\leq 2\%$.
- ④ This is only applied to TO-220AB package

Data and specifications subject to change without notice.

International
IR Rectifier

IR WORLD HEADQUARTERS: 233 Kansas St., El Segundo, California 90245, USA Tel: (310) 252-7105
TAC Fax: (310) 252-7903

Visit us at www.irf.com for sales contact information.07/04

www.irf.com

Note: For the most current drawings please refer to the IR website at:
<http://www.irf.com/package/>