

IRFHM9331PbF

HEXFET® Power MOSFET

V_{DS}	-30	V
$R_{DS(on) max}$ (@ $V_{GS} = -10V$)	14.6	mΩ
Q_g (typical)	32	nC
I_D (@ $T_A = 25^\circ C$)	-11	A

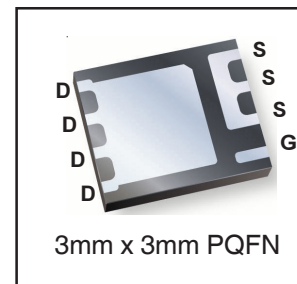
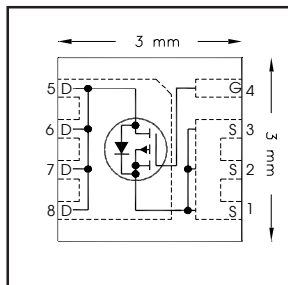

Applications

- System/load switch

Features and Benefits

Features

Low Thermal Resistance to PCB (<6.0°C/W)
Compatible with Existing Surface Mount Techniques
RoHS Compliant Containing no Lead, no Bromide and no Halogen
MSL1, Consumer Qualification

results in

⇒

Benefits

Enable better thermal dissipation
Easier Manufacturing
Environmentally Friendlier
Increased Reliability

Orderable part number	Package Type	Standard Pack		Note
		Form	Quantity	
IRFHM9331TRPBF	PQFN 3mm x 3mm	Tape and Reel	4000	

Absolute Maximum Ratings

	Parameter	Max.	Units
V_{DS}	Drain-to-Source Voltage	-30	V
V_{GS}	Gate-to-Source Voltage	± 25	
$I_D @ T_A = 25^\circ C$	Continuous Drain Current, $V_{GS} @ -10V$	-11	A
$I_D @ T_A = 70^\circ C$	Continuous Drain Current, $V_{GS} @ -10V$	-9	
$I_D @ T_C = 25^\circ C$	Continuous Drain Current, $V_{GS} @ -10V$	-24 ^⑦	
$I_D @ T_C = 70^\circ C$	Continuous Drain Current, $V_{GS} @ -10V$	-24	
I_{DM}	Pulsed Drain Current ^①	-90	
$P_D @ T_A = 25^\circ C$	Power Dissipation ^④	2.8	W
$P_D @ T_A = 70^\circ C$	Power Dissipation ^④	1.8	
	Linear Derating Factor	0.02	W/°C
T_J T_{STG}	Operating Junction and Storage Temperature Range	-55 to + 150	°C

Notes ^① through ^⑦ are on page 2

www.irf.com

Static @ $T_J = 25^\circ\text{C}$ (unless otherwise specified)

	Parameter	Min.	Typ.	Max.	Units	Conditions
BV_{DSS}	Drain-to-Source Breakdown Voltage	-30	—	—	V	$V_{GS} = 0V, I_D = -250\mu A$
$\Delta BV_{DSS}/\Delta T_J$	Breakdown Voltage Temp. Coefficient	—	0.02	—	V/ $^\circ\text{C}$	Reference to $25^\circ\text{C}, I_D = -1\text{mA}$
$R_{DS(on)}$	Static Drain-to-Source On-Resistance	—	10.0	—	m Ω	$V_{GS} = -20V, I_D = -11A$ ③
		—	11.7	14.6		$V_{GS} = -10V, I_D = -11A$ ③
$V_{GS(th)}$	Gate Threshold Voltage	-1.3	-1.8	-2.4	V	$V_{DS} = V_{GS}, I_D = -25\mu A$
$\Delta V_{GS(th)}$	Gate Threshold Voltage Coefficient	—	-5.1	—	mV/ $^\circ\text{C}$	
I_{DSS}	Drain-to-Source Leakage Current	—	—	-1.0	μA	$V_{DS} = -24V, V_{GS} = 0V$
		—	—	-150		$V_{DS} = -24V, V_{GS} = 0V, T_J = 125^\circ\text{C}$
I_{GSS}	Gate-to-Source Forward Leakage	—	—	-10	μA	$V_{GS} = -25V$
	Gate-to-Source Reverse Leakage	—	—	10		$V_{GS} = 25V$
g_{fs}	Forward Transconductance	16	—	—	S	$V_{DS} = -10V, I_D = -9.0A$
Q_g	Total Gate Charge ⑥	—	16	—	nC	$V_{DS} = -15V, V_{GS} = -4.5V, I_D = -9.0A$
Q_g	Total Gate Charge ⑥	—	32	48	nC	$V_{GS} = -10V$ $V_{DS} = -15V$ $I_D = -9.0A$
Q_{gs}	Gate-to-Source Charge ⑥	—	4.4	—		
Q_{gd}	Gate-to-Drain Charge ⑥	—	8	—		
R_G	Gate Resistance ⑥	—	16	—	Ω	
$t_{d(on)}$	Turn-On Delay Time	—	11	—	ns	$V_{DD} = -15V, V_{GS} = -4.5V$ ⑦ $I_D = -1.0A$ $R_G = 6.8\Omega$ See Figs. 19a & 19b
t_r	Rise Time	—	27	—		
$t_{d(off)}$	Turn-Off Delay Time	—	72	—		
t_f	Fall Time	—	60	—		
C_{iss}	Input Capacitance	—	1543	—	pF	$V_{GS} = 0V$ $V_{DS} = -25V$ $f = 1.0\text{KHz}$
C_{oss}	Output Capacitance	—	310	—		
C_{rss}	Reverse Transfer Capacitance	—	208	—		

Avalanche Characteristics

	Parameter	Typ.	Max.	Units
E_{AS}	Single Pulse Avalanche Energy ②	—	76	mJ
I_{AR}	Avalanche Current ①	—	-9.0	A

Diode Characteristics

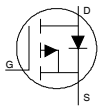
	Parameter	Min.	Typ.	Max.	Units	Conditions
I_S	Continuous Source Current (Body Diode)	—	—	-2.8	A	MOSFET symbol showing the integral reverse p-n junction diode. 
I_{SM}	Pulsed Source Current (Body Diode) ①	—	—	-90		
V_{SD}	Diode Forward Voltage	—	—	-1.2	V	$T_J = 25^\circ\text{C}, I_S = -2.8A, V_{GS} = 0V$ ③
t_{rr}	Reverse Recovery Time	—	64	96	ns	$T_J = 25^\circ\text{C}, I_F = -2.8A, V_{DD} = -24V$
Q_{rr}	Reverse Recovery Charge	—	25	38	nC	$di/dt = 100/\mu s$ ③

Thermal Resistance

	Parameter	Typ.	Max.	Units
$R_{\theta JC}$	Junction-to-Case ④	—	6	$^\circ\text{C/W}$
$R_{\theta JA}$	Junction-to-Ambient ④	—	45	
$R_{\theta JA}$	Junction-to-Ambient ($t < 10s$) ④	—	30	

Notes:

- ① Repetitive rating; pulse width limited by max. junction temperature.
- ② Starting $T_J = 25^\circ\text{C}$, $L = 1.904\text{mH}$, $R_G = 50\Omega$, $I_{AS} = -9A$.
- ③ Pulse width $\leq 400\mu s$; duty cycle $\leq 2\%$.
- ④ When mounted on 1 inch square copper board.
- ⑤ R_{θ} is measured at T_J of approximately 90°C .
- ⑥ For DESIGN AID ONLY, not subject to production testing.
- ⑦ Current limited by package.

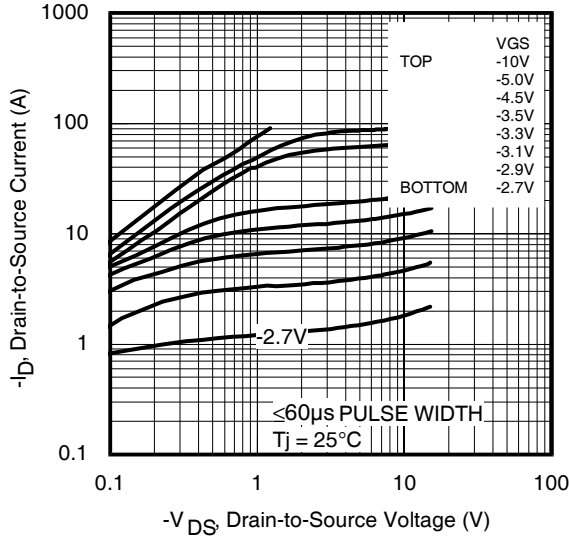

Fig 1. Typical Output Characteristics

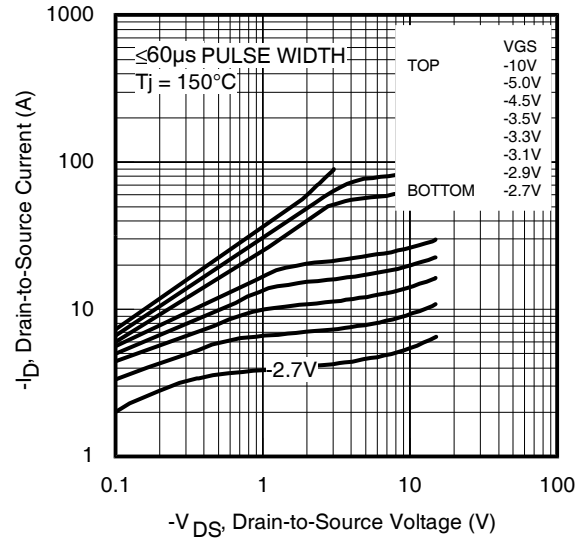

Fig 2. Typical Output Characteristics

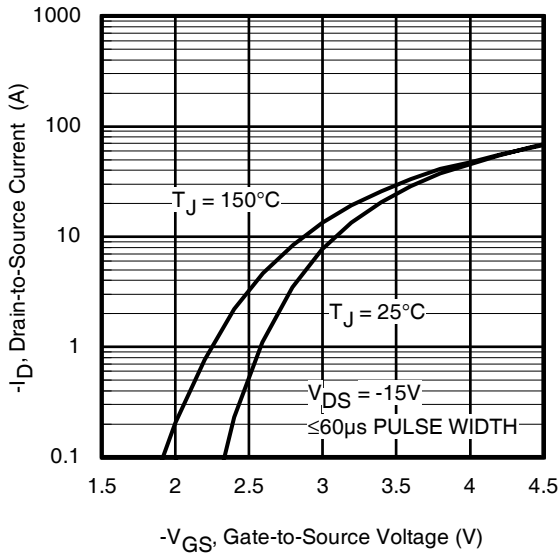

Fig 3. Typical Transfer Characteristics

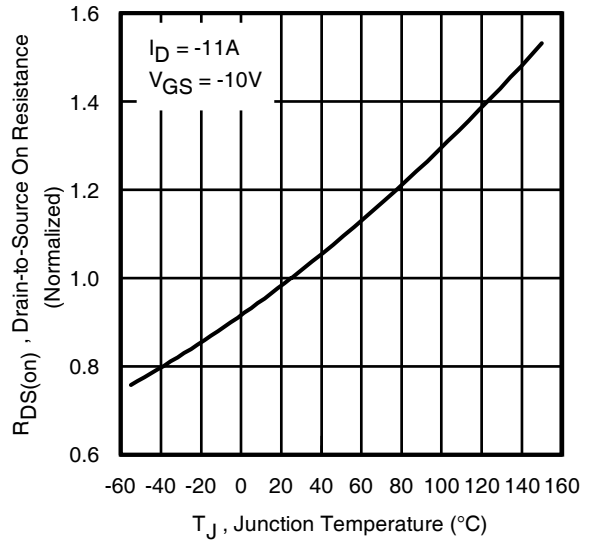

Fig 4. Normalized On-Resistance vs. Temperature

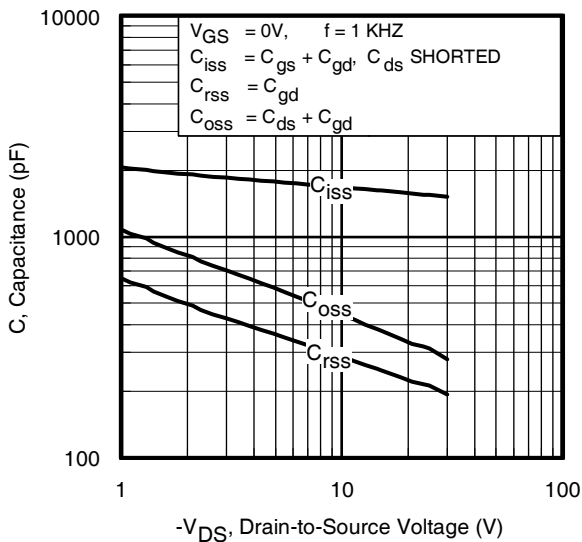

Fig 5. Typical Capacitance vs. Drain-to-Source Voltage
www.irf.com

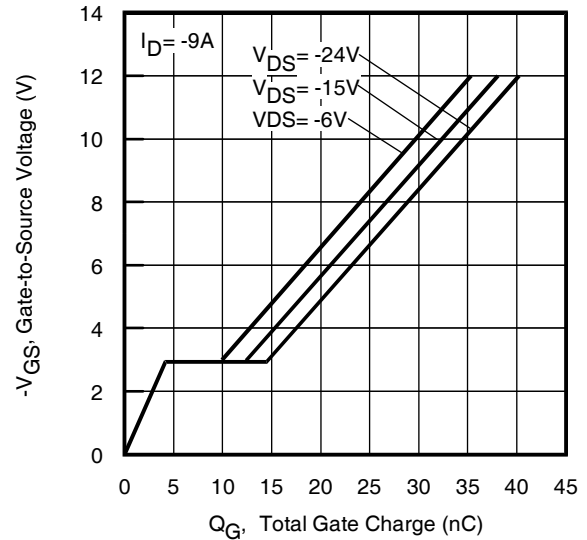

Fig 6. Typical Gate Charge vs. Gate-to-Source Voltage

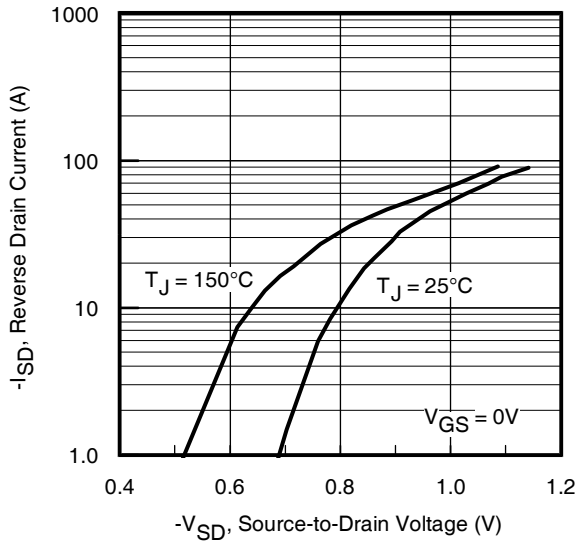

Fig 7. Typical Source-Drain Diode Forward Voltage

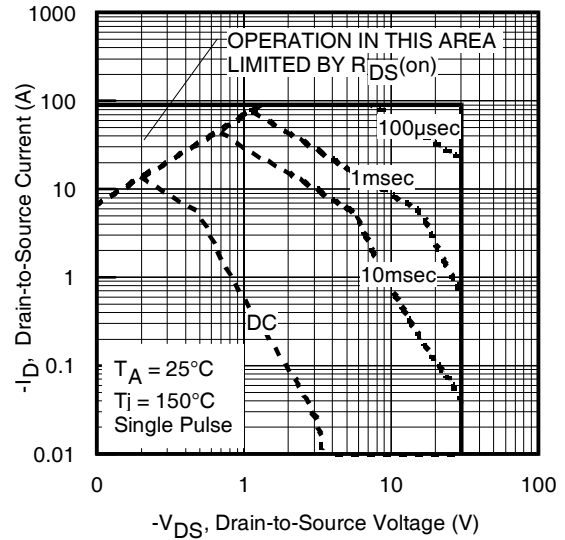

Fig 8. Maximum Safe Operating Area

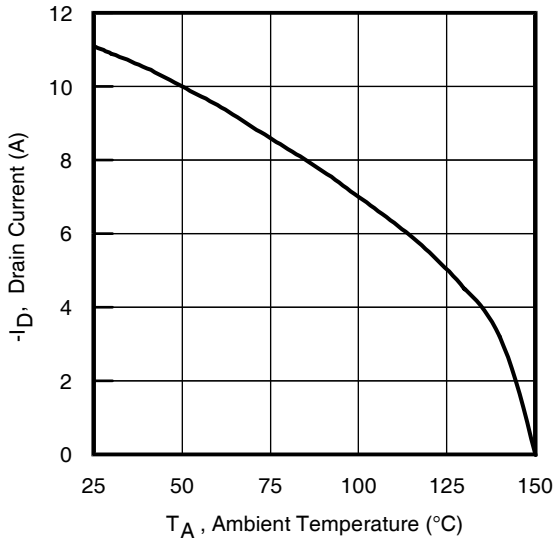

Fig 9. Maximum Drain Current vs. Ambient Temperature

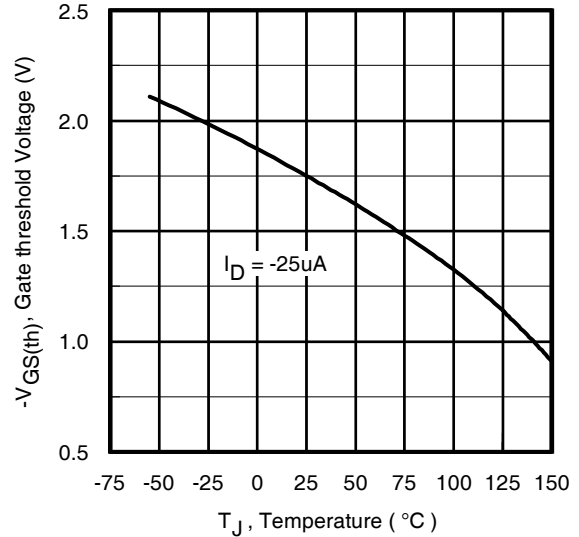

Fig 10. Threshold Voltage vs. Temperature

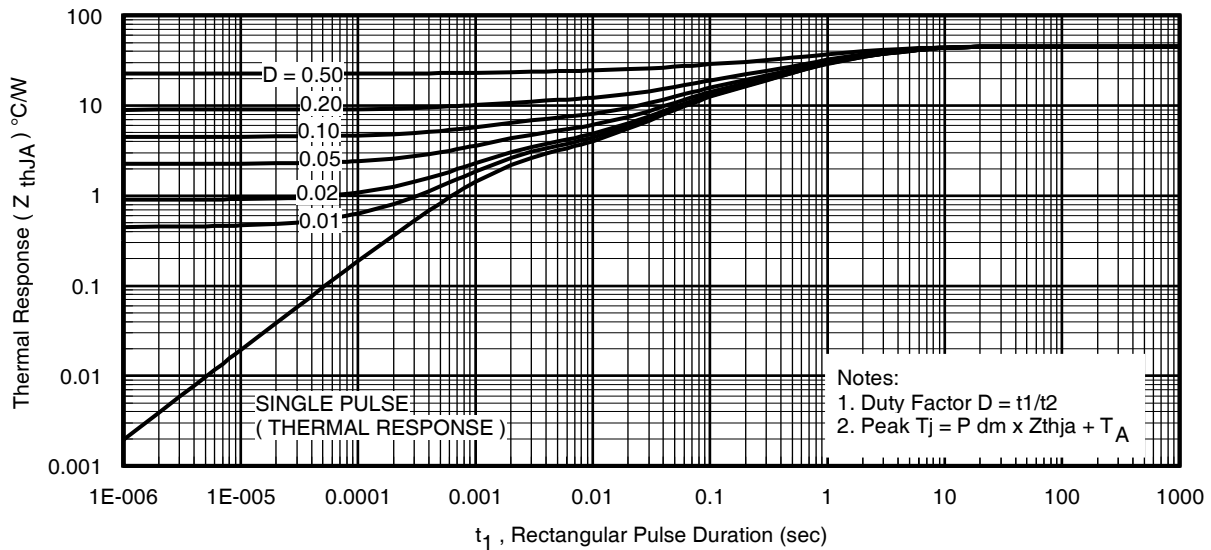

Fig 11. Maximum Effective Transient Thermal Impedance, Junction-to-Ambient

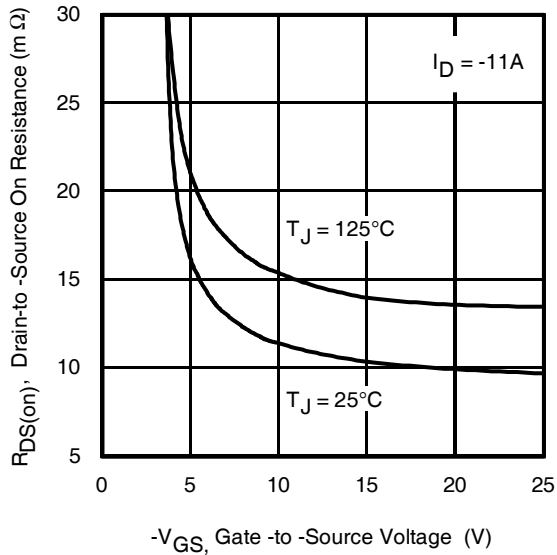

Fig 12. On-Resistance vs. Gate Voltage

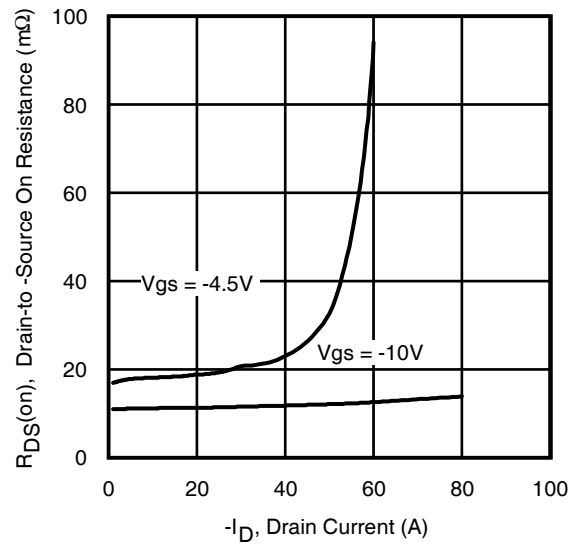

Fig 13. Typical On-Resistance vs. Drain Current

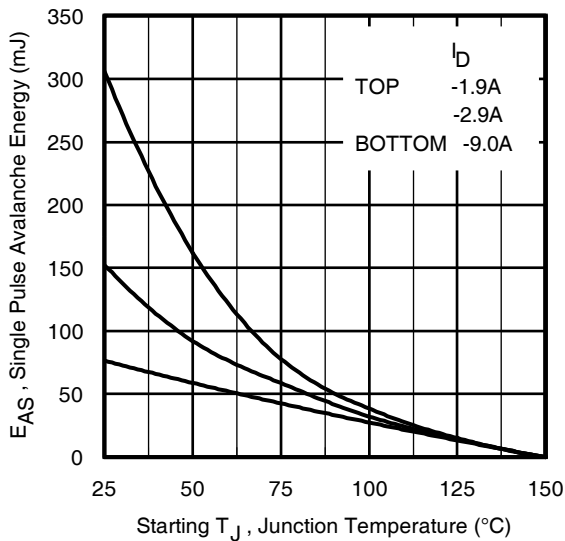

Fig 14. Maximum Avalanche Energy vs. Drain Current

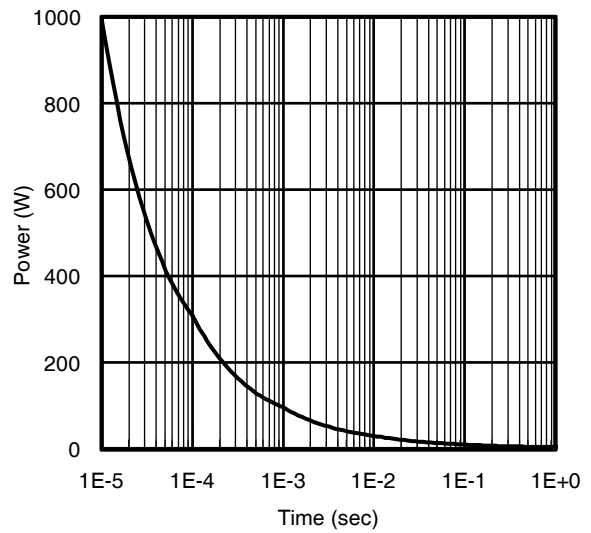
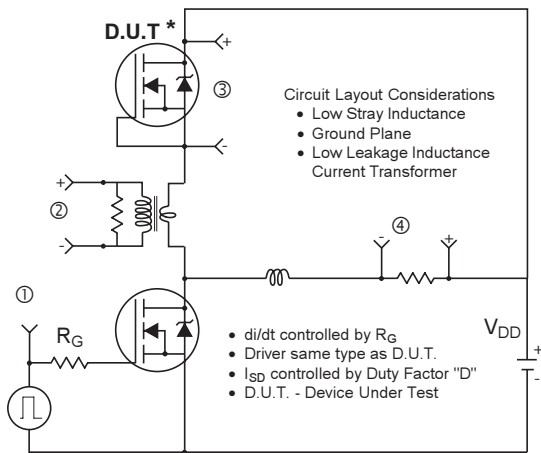
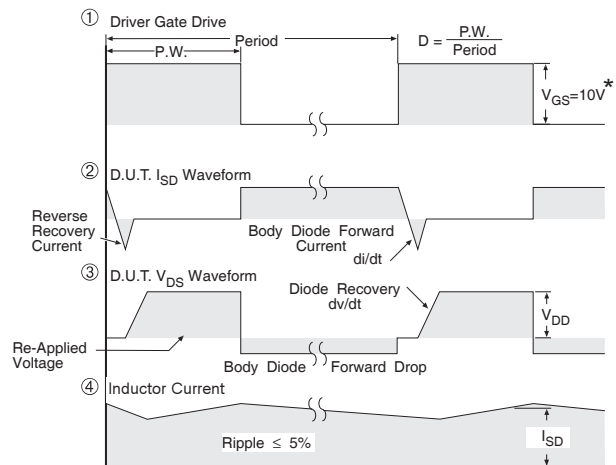

Fig 15. Typical Power vs. Time



* Reverse Polarity of D.U.T for P-Channel



* $V_{GS} = 5V$ for Logic Level Devices

Fig 16. Diode Reverse Recovery Test Circuit for P-Channel HEXFET® Power MOSFETs

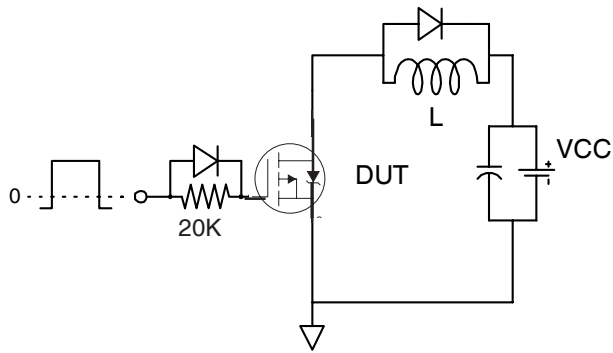

Fig 17a. Gate Charge Test Circuit



Fig 17b. Gate Charge Waveform

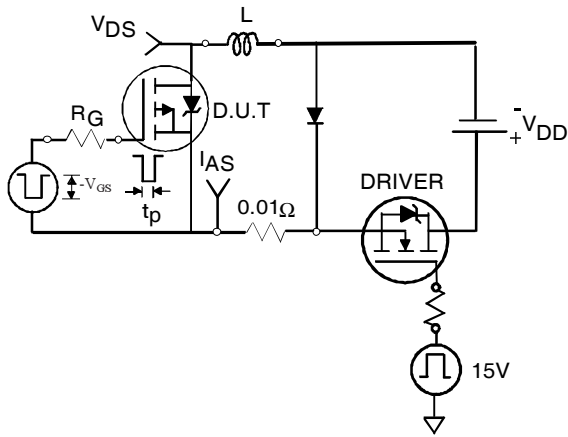

Fig 18a. Unclamped Inductive Test Circuit



Fig 18b. Unclamped Inductive Waveforms

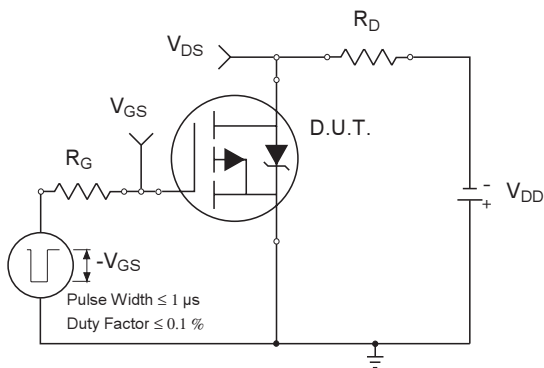

Fig 19a. Switching Time Test Circuit

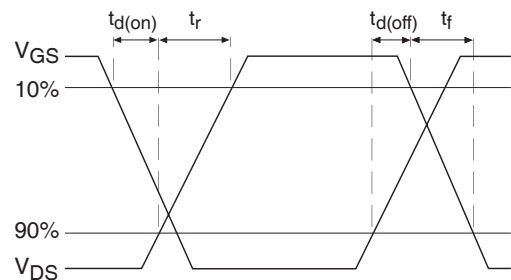
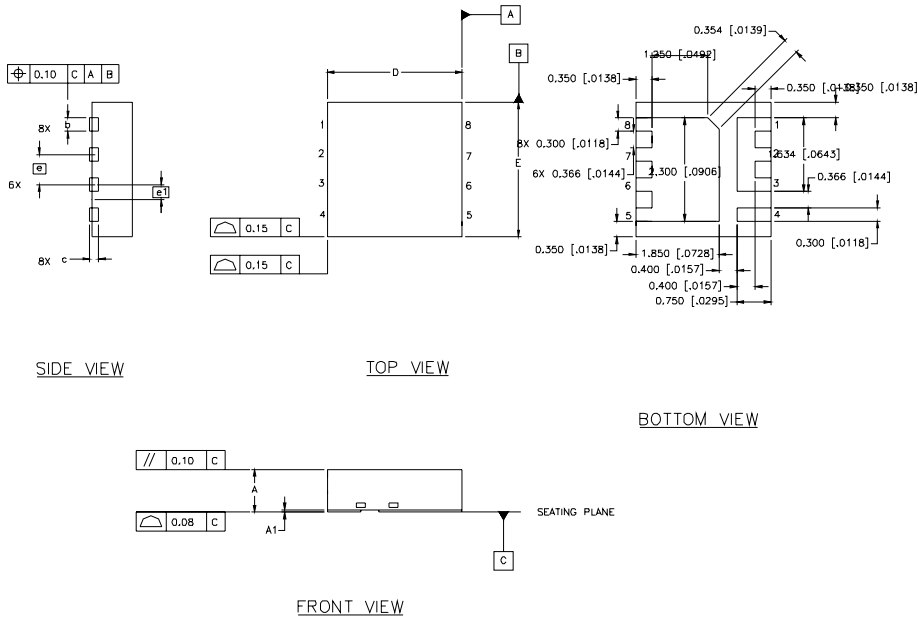

Fig 19b. Switching Time Waveforms

PQFN Package Details



DIM	INCHES		MILLIMETERS	
	MIN	MAX	MIN	MAX
A	.0315	.0394	0.800	1.000
A1	.0000	.0020	0.000	0.050
b	.0098	.0138	0.250	0.350
c	.0080 REF.		0.203 REF.	
D	.1181 BASIC		3.000	BASIC
E	.1181 BASIC		3.000	BASIC
e	.0262 BASIC		0.666 BASIC	
e1	.0131 BASIC		0.333 BASIC	

PQFN Part Marking

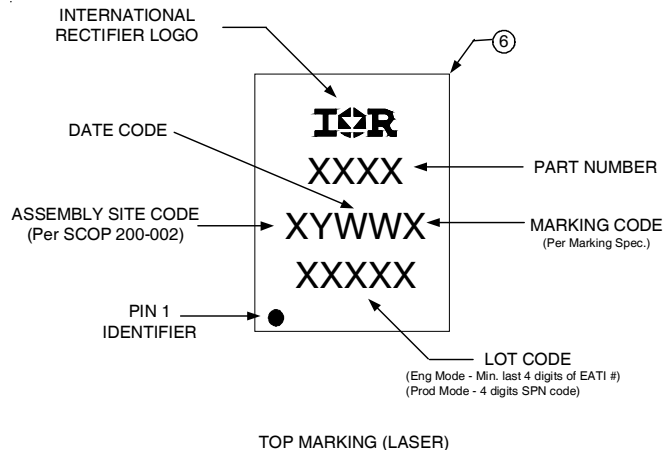

Note: For the most current drawing please refer to IR website at: <http://www.irf.com/package/>

PQFN Tape and Reel

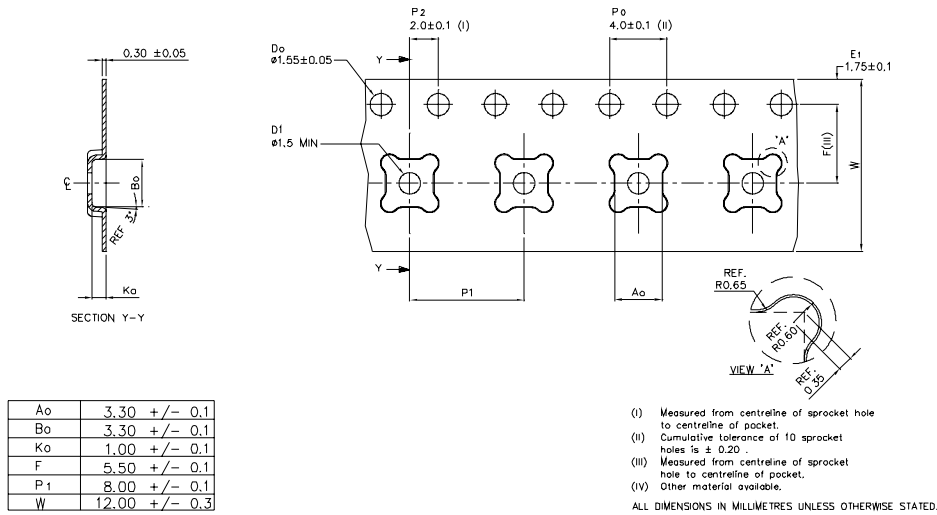

Qualification information[†]

Qualification level	Consumer ^{††} (per JEDEC JESD47F ^{†††} guidelines)	
Moisture Sensitivity Level	PQFN 3mm x 3mm	MSL1 (per IPC/JEDEC J-ST D-020D ^{†††})
RoHS compliant	Yes	

[†] Qualification standards can be found at International Rectifier's web site
<http://www.irf.com/product-info/reliability>

^{††} Higher qualification ratings may be available should the user have such requirements.
 Please contact your International Rectifier sales representative for further information:
<http://www.irf.com/whoto-call/salesrep/>

^{†††} Applicable version of JEDEC standard at the time of product release.

Data and specifications subject to change without notice.

International
IR Rectifier

IR WORLD HEADQUARTERS: 233 Kansas St., El Segundo, California 90245, USA Tel: (310) 252-7105
 TAC Fax: (310) 252-7903

Visit us at www.irf.com for sales contact information.06/2010

www.irf.com