

# IRF7353D2PbF

**FETKY™** MOSFET / Schottky Diode

- Co-Pack HEXFET® Power MOSFET and Schottky Diode
- Ideal For Buck Regulator Applications
- N-Channel HEXFET power MOSFET
- Low  $V_F$  Schottky Rectifier
- Generation 5 Technology
- SO-8 Footprint
- Lead-Free

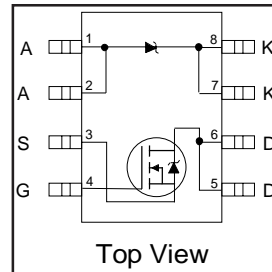

$V_{DSS} = 30V$
$R_{DS(on)} = 0.029\Omega$
Schottky $V_F = 0.52V$

## Description

The **FETKY™** family of Co-Pack HEXFET® Power MOSFETs and Schottky diodes offers the designer an innovative, board space saving solution for switching regulator and power management applications. Generation 5 HEXFET power MOSFETs utilize advanced processing techniques to achieve extremely low on-resistance per silicon area. Combining this technology with International Rectifier's low forward drop Schottky rectifiers results in an extremely efficient device suitable for use in a wide variety of portable electronics applications.

The SO-8 has been modified through a customized leadframe for enhanced thermal characteristics. The SO-8 package is designed for vapor phase, infrared or wave soldering techniques.

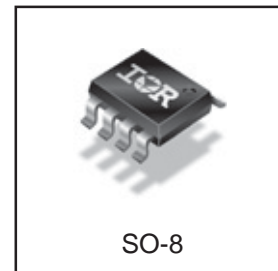

## Absolute Maximum Ratings ( $T_A = 25^\circ C$ unless otherwise noted)

Parameter		Maximum	Units
$I_D @ T_A = 25^\circ C$	Continuous Drain Current ④	6.5	A
$I_D @ T_A = 70^\circ C$		5.2	
$I_{DM}$	Pulsed Drain Current ①	52	
$P_D @ T_A = 25^\circ C$	Power Dissipation ④	2.0	W
$P_D @ T_A = 70^\circ C$		1.3	
	Linear Derating Factor	16	mW/°C
$V_{GS}$	Gate-to-Source Voltage	$\pm 20$	V
$dv/dt$	Peak Diode Recovery $dv/dt$ ②	-5.0	V/ns
$T_J, T_{STG}$	Junction and Storage Temperature Range	-55 to +150	°C

## Thermal Resistance Ratings

Parameter		Maximum	Units
$R_{\theta JA}$	Junction-to-Ambient ⑤	62.5	°C/W

### Notes:

- ① Repetitive rating; pulse width limited by maximum junction temperature (see figure 9)
- ② Starting  $T_J = 25^\circ C$ ,  $L = 10mH$ ,  $R_G = 25\Omega$ ,  $I_{AS} = 4.0A$
- ③  $I_{SD} \leq 4.0A$ ,  $di/dt \leq 74A/\mu s$ ,  $V_{DD} \leq V_{(BR)DSS}$ ,  $T_J \leq 150^\circ C$
- ④ Pulse width  $\leq 300\mu s$ ; duty cycle  $\leq 2\%$
- ⑤ Surface mounted on FR-4 board,  $t \leq 10sec$ .

www.irf.com

**MOSFET Electrical Characteristics @ T<sub>J</sub> = 25°C (unless otherwise specified)**

Parameter		Min.	Typ.	Max.	Units	Conditions
V <sub>(BR)DSS</sub>	Drain-to-Source Breakdown Voltage	30	—	—	V	V <sub>GS</sub> = 0V, I <sub>D</sub> = 250μA
R <sub>DS(on)</sub>	Static Drain-to-Source On-Resistance	—	0.023	0.029	Ω	V <sub>GS</sub> = 10V, I <sub>D</sub> = 5.8A ④
		—	0.032	0.046		V <sub>GS</sub> = 4.5V, I <sub>D</sub> = 4.7A ④
V <sub>GS(th)</sub>	Gate Threshold Voltage	1.0	—	—	V	V <sub>DS</sub> = V <sub>GS</sub> , I <sub>D</sub> = 250μA
g <sub>fs</sub>	Forward Transconductance	—	14	—	S	V <sub>DS</sub> = 24V, I <sub>D</sub> = 5.8A
I <sub>DSS</sub>	Drain-to-Source Leakage Current	—	—	1.0	μA	V <sub>DS</sub> = 24V, V <sub>GS</sub> = 0V
		—	—	25		V <sub>DS</sub> = 24V, V <sub>GS</sub> = 0V, T <sub>J</sub> = 55°C
I <sub>GSS</sub>	Gate-to-Source Forward Leakage	—	—	100	nA	V <sub>GS</sub> = 20V
	Gate-to-Source Reverse Leakage	—	—	-100		V <sub>GS</sub> = -20V
Q <sub>g</sub>	Total Gate Charge	—	22	33	nC	I <sub>D</sub> = 5.8A
Q <sub>gs</sub>	Gate-to-Source Charge	—	2.6	3.9		V <sub>DS</sub> = 24V
Q <sub>gd</sub>	Gate-to-Drain ("Miller") Charge	—	6.4	9.6		V <sub>GS</sub> = 10V (see figure 8) ④
t <sub>d(on)</sub>	Turn-On Delay Time	—	8.1	12	ns	V <sub>DD</sub> = -5V
t <sub>r</sub>	Rise Time	—	8.9	13		I <sub>D</sub> = 1.0A
t <sub>d(off)</sub>	Turn-Off Delay Time	—	26	39		R <sub>G</sub> = 6.0Ω
t <sub>f</sub>	Fall Time	—	18	26		R <sub>D</sub> = 15Ω ④
C <sub>iss</sub>	Input Capacitance	—	650	—	pF	V <sub>GS</sub> = 0V
C <sub>oss</sub>	Output Capacitance	—	320	—		V <sub>DS</sub> = 25V
C <sub>rss</sub>	Reverse Transfer Capacitance	—	130	—		f = 1.0MHz (see figure 7)

**MOSFET Source-Drain Ratings and Characteristics**

Parameter		Min.	Typ.	Max.	Units	Conditions
I <sub>S</sub>	Continuous Source Current (Body Diode)	—	—	2.5	A	
I <sub>SM</sub>	Pulsed Source Current (Body Diode)	—	—	30		
V <sub>SD</sub>	Body Diode Forward Voltage	—	0.78	1.0	V	T <sub>J</sub> = 25°C, I <sub>S</sub> = 1.7A, V <sub>GS</sub> = 0V
t <sub>rr</sub>	Reverse Recovery Time (Body Diode)	—	45	68	ns	T <sub>J</sub> = 25°C, I <sub>F</sub> = 1.7A
Q <sub>rr</sub>	Reverse Recovery Charge	—	58	87	nC	di/dt = 100A/μs ③

**Schottky Diode Maximum Ratings**

	Parameter	Max.	Units	Conditions
I <sub>F(av)</sub>	Max. Average Forward Current	3.2	A	50% Duty Cycle. Rectangular Wave, T <sub>c</sub> = 25°C
		2.0		50% Duty Cycle. Rectangular Wave, T <sub>c</sub> = 70°C
I <sub>SM</sub>	Max. peak one cycle Non-repetitive Surge current	200	A	5μs sine or 3μs Rect. pulse
		20		10ms sine or 6ms Rect. pulse
				Following any rated load condition & with V <sub>rrm</sub> applied

**Schottky Diode Electrical Specifications**

	Parameter	Max.	Units	Conditions
V <sub>FM</sub>	Max. Forward voltage drop	0.57	V	I <sub>f</sub> = 3.0, T <sub>J</sub> = 25°C
		0.77		I <sub>f</sub> = 6.0, T <sub>J</sub> = 25°C
		0.52		I <sub>f</sub> = 3.0, T <sub>J</sub> = 125°C
		0.79		I <sub>f</sub> = 6.0, T <sub>J</sub> = 125°C
I <sub>rm</sub>	Max. Reverse Leakage current	0.30	mA	V <sub>r</sub> = 30V, T <sub>J</sub> = 25°C
		37		T <sub>J</sub> = 125°C
C <sub>t</sub>	Max. Junction Capacitance	310	pF	V <sub>r</sub> = 5Vdc (100kHz to 1 MHz) 25°C
dv/dt	Max. Voltage Rate of Charge	4900	V/μs	Rated V <sub>r</sub>

( HEXFET is the reg. TM for International Rectifier Power MOSFET's )

**Power MOSFET Characteristics**

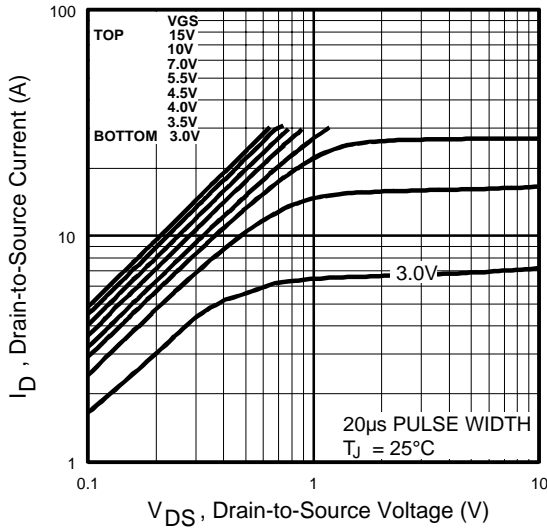

**Fig 1.** Typical Output Characteristics

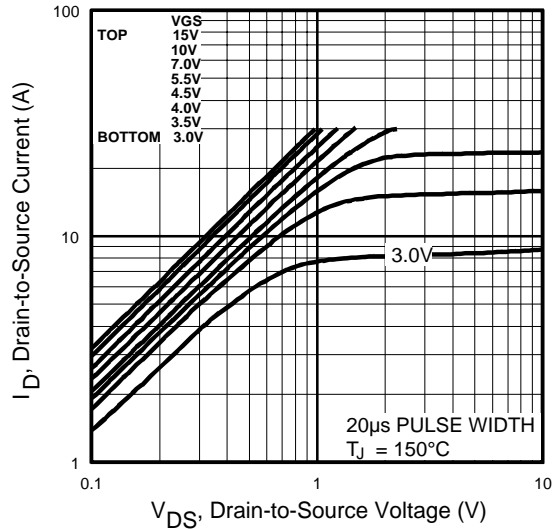

**Fig 2.** Typical Output Characteristics

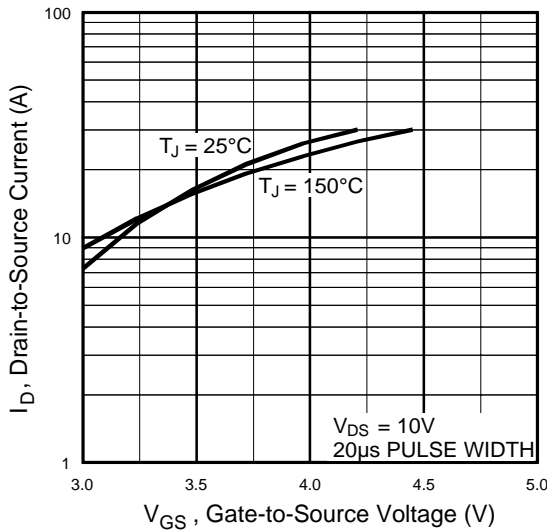

**Fig 3.** Typical Transfer Characteristics

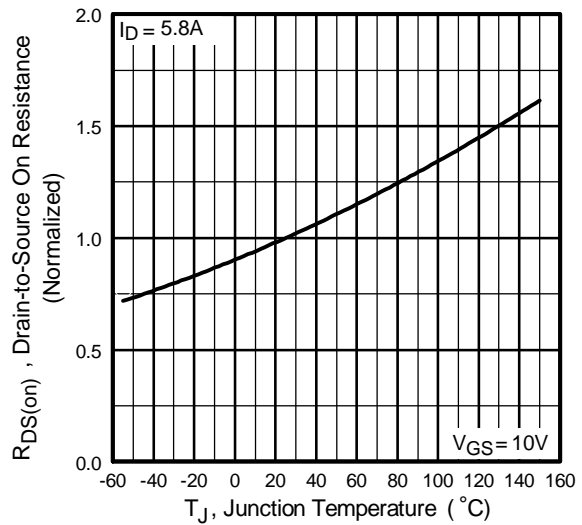

**Fig 4.** Normalized On-Resistance Vs. Temperature

Power MOSFET Characteristics

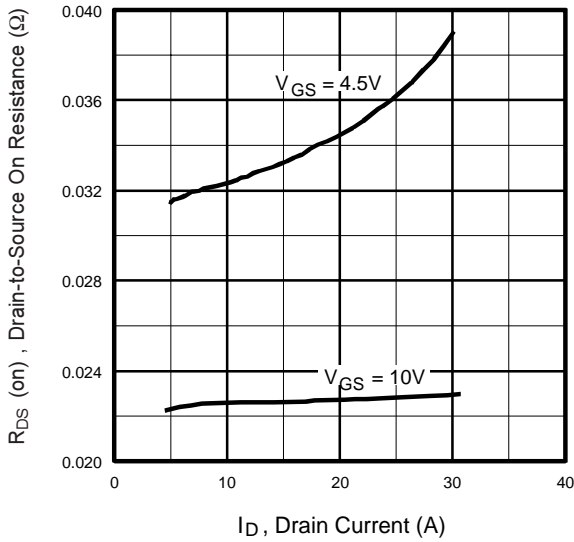

Fig 5. Typical On-Resistance Vs. Drain Current

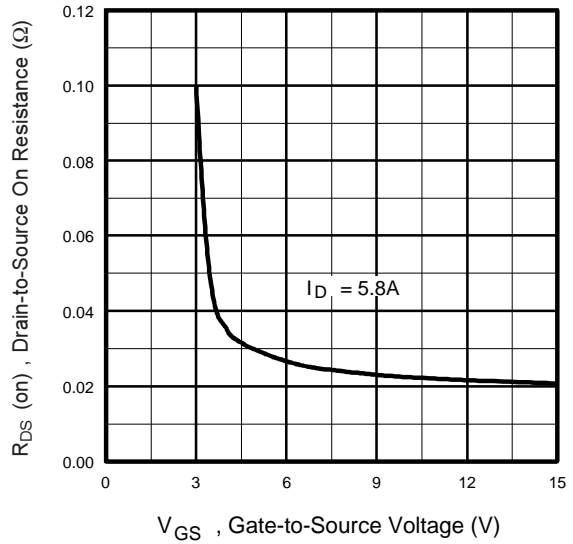

Fig 6. Typical On-Resistance Vs. Gate Voltage

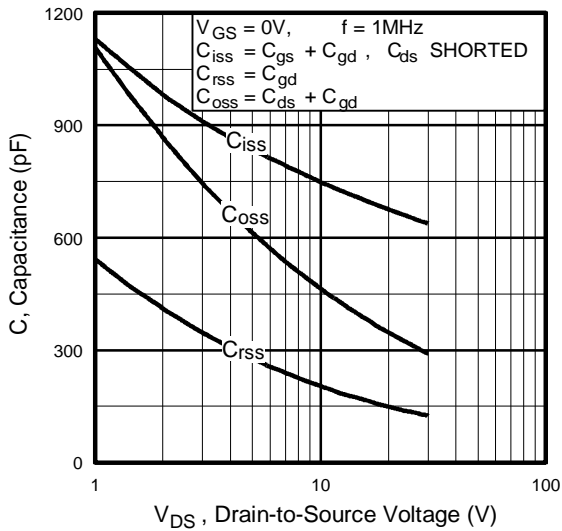

Fig 7. Typical Capacitance Vs. Drain-to-Source Voltage

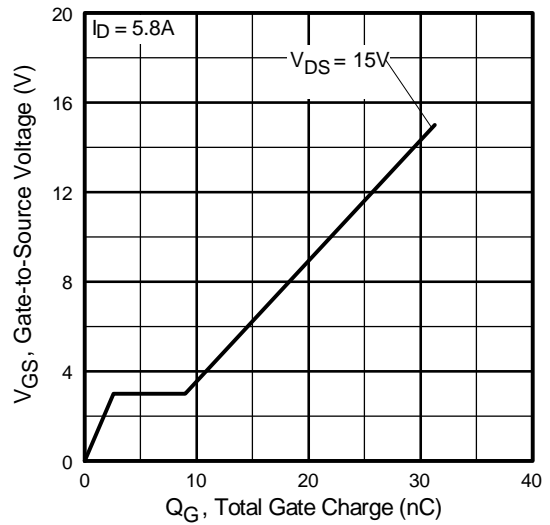

Fig 8. Typical Gate Charge Vs. Gate-to-Source Voltage

Power MOSFET Characteristics

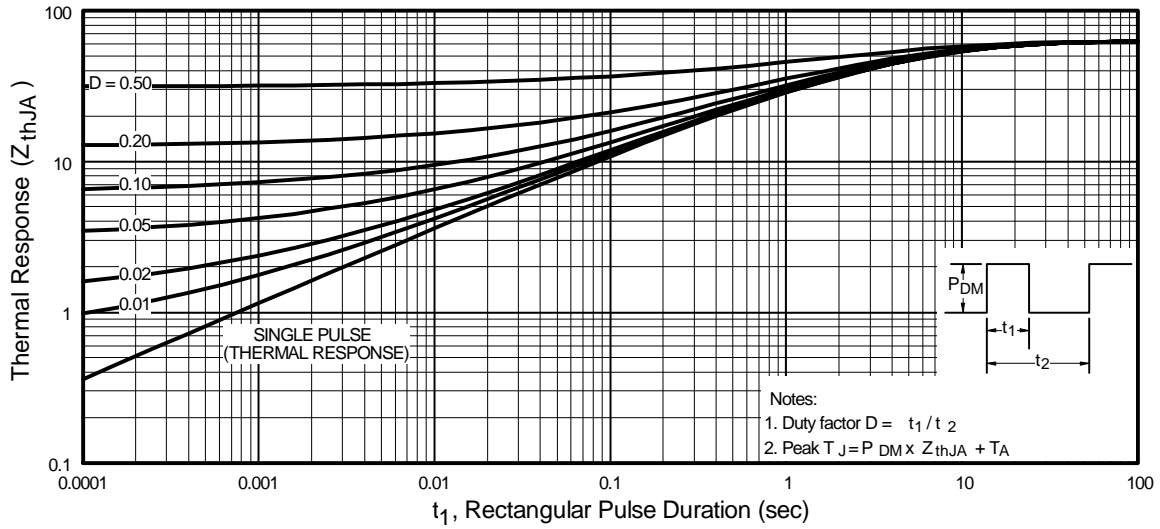

Fig 9. Maximum Effective Transient Thermal Impedance, Junction-to-Ambient

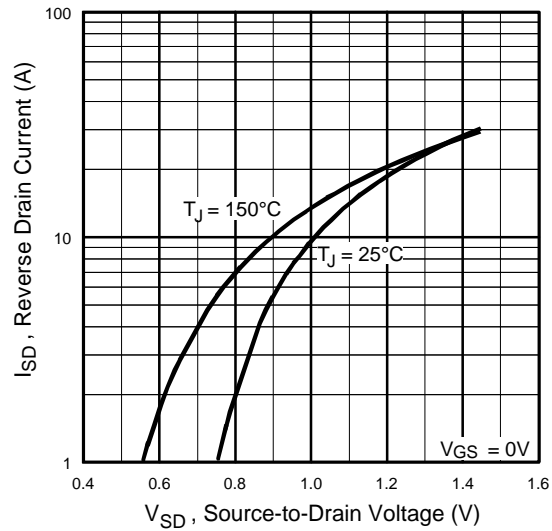

Fig 10. Typical Source-Drain Diode Forward Voltage

Schottky Diode Characteristics

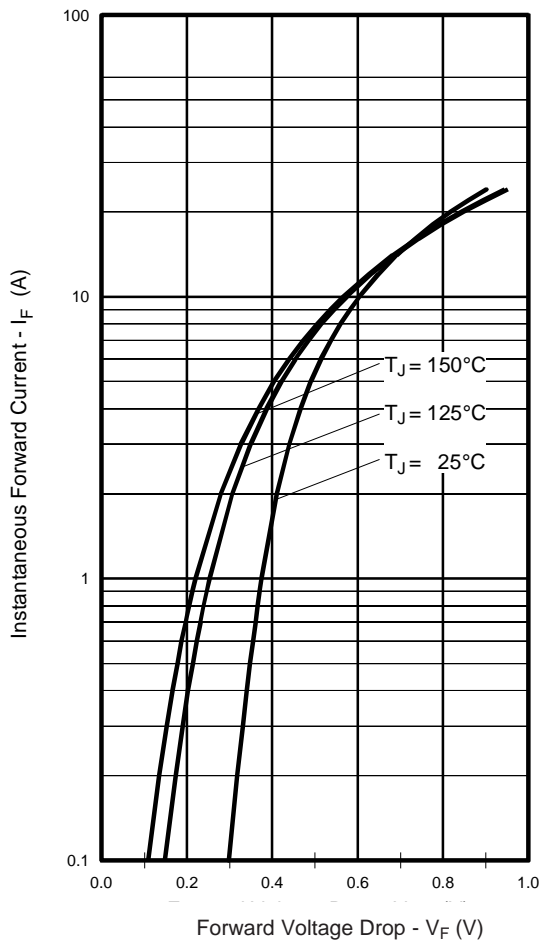

Fig. 12 - Typical Forward Voltage Drop Characteristics

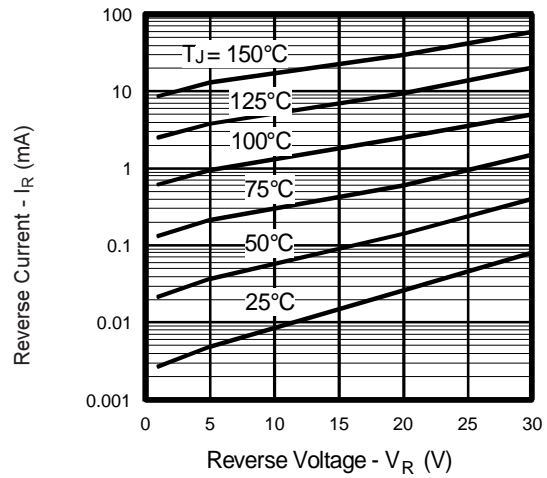

Fig. 13 - Typical Values of Reverse Current Vs. Reverse Voltage

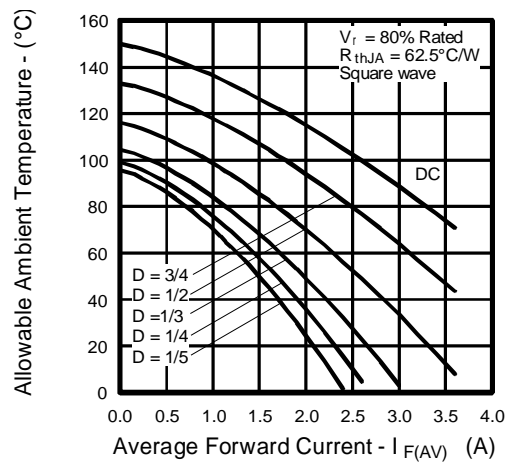
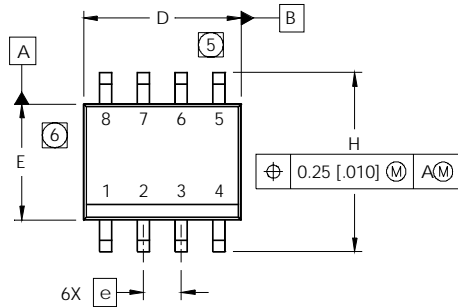

Fig.14 - Maximum Allowable Ambient Temp. Vs. Forward Current

## SO-8 (Fetky) Package Outline

Dimensions are shown in millimeters (inches)



DIM	INCHES		MILLIMETERS	
	MIN	MAX	MIN	MAX
A	.0532	.0688	1.35	1.75
A1	.0040	.0098	0.10	0.25
b	.013	.020	0.33	0.51
c	.0075	.0098	0.19	0.25
D	.189	.1968	4.80	5.00
E	.1497	.1574	3.80	4.00
e	.050 BASIC		1.27 BASIC	
e1	.025 BASIC		0.635 BASIC	
H	.2284	.2440	5.80	6.20
K	.0099	.0196	0.25	0.50
L	.016	.050	0.40	1.27
y	0°	8°	0°	8°

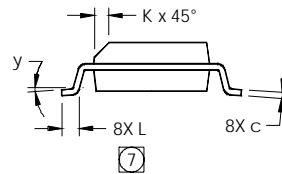
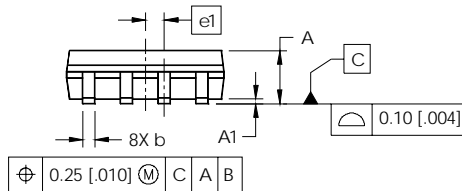

**NOTES:**

1. DIMENSIONING & TOLERANCING PER ASME Y14.5M-1994.
2. CONTROLLING DIMENSION: MILLIMETER
3. DIMENSIONS ARE SHOWN IN MILLIMETERS [INCHES].
4. OUTLINE CONFORMS TO JEDEC OUTLINE MS-012AA
5. DIMENSION DOES NOT INCLUDE MOLD PROTRUSIONS. MOLD PROTRUSIONS NOT TO EXCEED 0.15 [0.006].
6. DIMENSION DOES NOT INCLUDE MOLD PROTRUSIONS. MOLD PROTRUSIONS NOT TO EXCEED 0.25 [0.010].
7. DIMENSION IS THE LENGTH OF LEAD FOR SOLDERING TO A SUBSTRATE.

**FOOTPRINT**

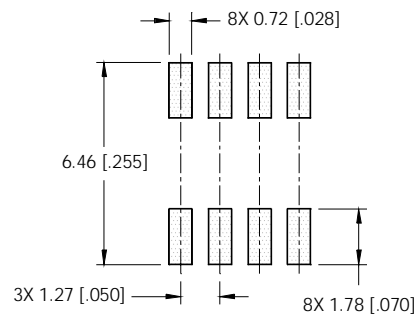

## SO-8 (Fetky) Part Marking Information

EXAMPLE: THIS IS AN IRF7807D1 (FETKY)

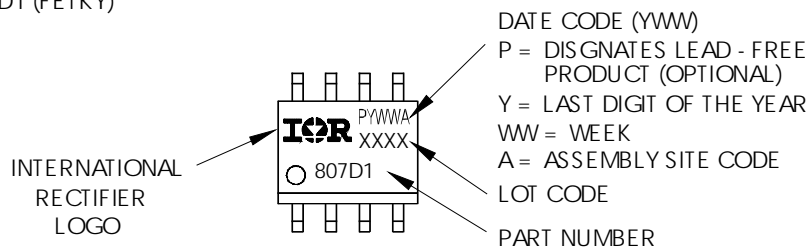

# IRF7353D2PbF

International  
**IR** Rectifier

## SO-8 (Fetky) Tape and Reel

Dimensions are shown in millimeters (inches)

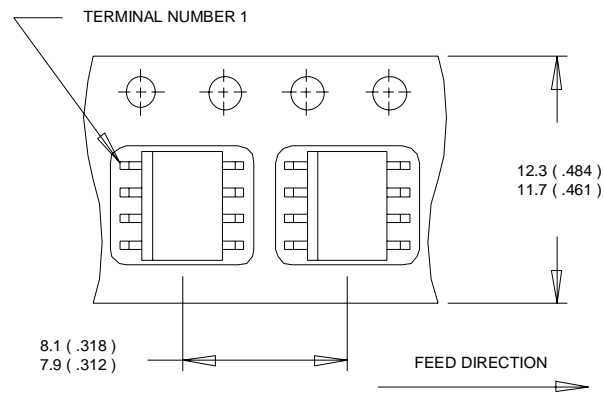

- NOTES:
1. CONTROLLING DIMENSION : MILLIMETER.
  2. ALL DIMENSIONS ARE SHOWN IN MILLIMETERS(INCHES).
  3. OUTLINE CONFORMS TO EIA-481 & EIA-541.

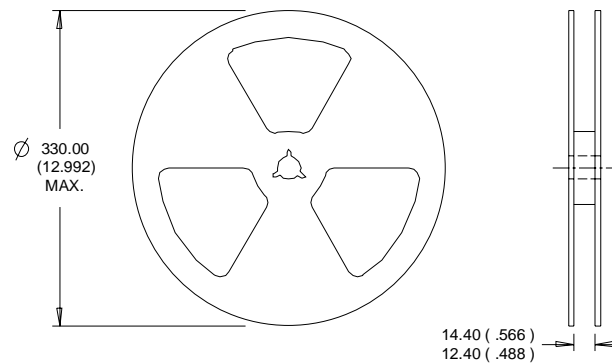

- NOTES :
1. CONTROLLING DIMENSION : MILLIMETER.
  2. OUTLINE CONFORMS TO EIA-481 & EIA-541.

Data and specifications subject to change without notice.  
This product has been designed and qualified for the Consumer market.  
Qualification Standards can be found on IR's Web site.

International  
**IR** Rectifier

IR WORLD HEADQUARTERS: 233 Kansas St., El Segundo, California 90245, USA Tel: (310) 252-7105  
TAC Fax: (310) 252-7903

Visit us at [www.irf.com](http://www.irf.com) for sales contact information.10/04

[www.irf.com](http://www.irf.com)