

Ceramic Resonator (CERALOCK®)



Application Manual

muRata *Innovator
in Electronics*

Murata
Manufacturing Co., Ltd.

Cat.No.P17E-16

Introduction

Ceramic resonators (CERALOCK®) are made of high stability piezoelectric ceramics that function as a mechanical resonator.

This device has been developed to function as a reference signal generator and the frequency is primarily adjusted by the size and thickness of the ceramic element.

With the advance of the IC technology, various equipment may be controlled by a single LSI integrated circuit, such as the one-chip microprocessor.

CERALOCK® can be used as the timing element in most microprocessor based equipment.

In the future, more and more applications will use CERALOCK® because of its high stability non-adjustment performance, miniature size and cost savings. Typical applications include TVs, VCRs, automotive electronic devices, telephones, copiers, cameras, voice synthesizers, communication equipment, remote controls and toys.

This manual describes CERALOCK® and will assist you in applying it effectively.

* CERALOCK® is the brand name of these MURATA products.

1	Characteristics and Types of CERALOCK® —	2
1.	General Characteristics of CERALOCK®	2
2.	Types of CERALOCK®	3
kHz Band CERALOCK® (CSBLA Series)	3	
MHz Band CERALOCK® with Built-in Load Capacitance (CSTLS Series)	4	
Reflow Solderable kHz Band CERALOCK® (CSBFB Series)	5	
MHz Band Chip CERALOCK® (CSACW/CSTCC/ CSTCR/CSTCE/CSTCW Series)	6	
2	Principles of CERALOCK® —	8
1.	Equivalent Circuit Constants	8
2.	Basic Oscillation Circuits	11
3	Specifications of CERALOCK® —	14
1.	Electrical Specifications	14
Electrical Specifications of kHz Band CSBLA Series	14	
Electrical Specifications of MHz Band Lead CERALOCK® (CSTLS Series)	15	
Electrical Specifications of MHz Band Chip CERALOCK® (CSACW Series) (CSTCC/CSTCR/CSTCE/CSTCW Series)	16	
2.	Mechanical and Environmental Specifications of CERALOCK®	17
4	Applications of Typical Oscillation Circuits —	19
1.	Cautions for Designing Oscillation Circuits	19
2.	Application to Various Oscillation Circuits	20
Application to C-MOS Inverter	20	
Application to H-CMOS Inverter	21	
5	Characteristics of CERALOCK® Oscillation Circuits —	22
1.	Stability of Oscillation Frequency	22
2.	Characteristics of the Oscillation Level	23
3.	Characteristics of Oscillation Rise Time	24
4.	Starting Voltage	25
6	Application Circuits to Various ICs/LSIs —	26
1.	Application to Microcomputers	26
2.	Application to Remote Control ICs	29
3.	Application to ICs for Office Equipment	29
4.	Other Kinds of Applications to Various ICs	29
7	Notice —	30
8	Appendix Equivalent Circuit Constants of CERALOCK® —	31

<h1>CONTENTS</h1>	
1	Characteristics and Types of CERALOCK®
2	Principles of CERALOCK®
3	Specifications of CERALOCK®
4	Applications of Typical Oscillation Circuits
5	Characteristics of CERALOCK® Oscillation Circuits
6	Application Circuits to Various ICs/LSIs
7	Notice
8	Appendix Equivalent Circuit Constants of CERALOCK®

1 Characteristics and Types of CERALOCK®

1. General Characteristics of CERALOCK®

1

Ceramic resonators use the mechanical resonance of piezoelectric ceramics. (Generally, lead zirconium titanate: PZT.)

The oscillation mode varies with resonant frequency. The table on the right shows this relationship.

As a resonator device, quartz crystal is well-known. RC oscillation circuits and LC oscillation circuits are also used to produce electrical resonance. The following are the characteristics of CERALOCK®.

- ① High stability of oscillation frequency
Oscillation frequency stability is between that of the quartz crystal and LC or RC oscillation circuits. The temperature coefficient of quartz crystal is $10^{-6}/^{\circ}\text{C}$ maximum and approximately 10^{-3} to $10^{-4}/^{\circ}\text{C}$ for LC or RC oscillation circuits. Compared with these, it is $10^{-5}/^{\circ}\text{C}$ at -20 to $+80^{\circ}\text{C}$ for ceramic resonators.

- ② Small configuration and light weight
The ceramic resonator is half the size of popular quartz crystals.







- ③ Low price, non-adjustment
CERALOCK® is mass produced, resulting in low cost and high stability.

Unlike RC or LC circuits, ceramic resonators use mechanical resonance. This means it is not basically affected by external circuits or by the fluctuation of the supply voltage.

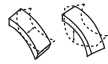
Highly stable oscillation circuits can therefore be made without the need of adjustment.

The table briefly describes the characteristics of various oscillator elements.

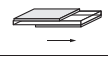
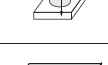
■ Vibration Mode and Frequency Range

Vibration Mode		Frequency (Hz)						
		1k	10k	100k	1M	10M	100M	1G
1	Flexural mode 	█	█					
2	Length mode 			█	█			
3	Area expansion mode 			█	█			
4	Radius vibration 			█	█			
5	Shear thickness mode 					█	█	
6	Thickness expander mode 					█	█	
7	Surface acoustic wave 							█

[Note] :  show the direction of vibration

■ Characteristics of Various Oscillator Elements

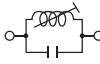
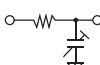
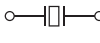
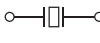
Name	Symbol	Price	Size	Adjustment	Oscillation Frequency Initial Tolerance	Long-term Stability
LC		Inexpensive	Big	Required	±2.0%	Fair
CR		Inexpensive	Small	Required	±2.0%	Fair
Quartz Crystal		Expensive	Big	Not required	±0.001%	Excellent
Ceramic Resonator		Inexpensive	Small	Not required	±0.5%	Excellent

Characteristics and Types of CERALOCK® 1

2. Types of CERALOCK®

kHz Band CERALOCK® (CSBLA Series)

The CSBLA series uses a vibration mode of the piezoelectric ceramic element. The dimensions of this element vary with frequency. The ceramic element is sealed in a plastic case and the size of the case also varies with the frequency band. Washable products are available in all the frequencies ; however, three standard products (375 to 699kHz) are also made in less expensive non-washable models.

■ Part Numbering



- ① Product ID
- ② Frequency/No capacitance built-in
- ③ Structure/Size
- ④ Nominal Center Frequency
- ⑤ Type
E : Area Expansion mode,
J : Area Expansion mode (Closed Type)
- ⑥ Frequency Tolerance
2 : ±0.2%, 3 : ±0.3%, 5 : ±0.5%,
B : 1kHz, C : ±2kHz, Z : Others
- ⑦ Load Capacitance Value
- ⑧ Individual Specification
With standard products, "⑧ individual Specification" is omitted, and "⑨ Package Specification Code" is carried up.
- ⑨ Packaging
-B0 : Bulk

■ Part Numbers and Dimensions of kHz Band CERALOCK® (CSBLA Series) (Standard Products)

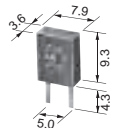
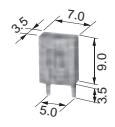
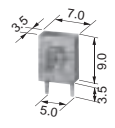
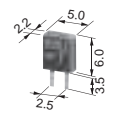
Part Number	Frequency (kHz)	Dimensions (in mm)
CSBLA□□E Non-Washable	375-429	
	430-509	
	510-699	
CSBLA□□J Washable* (Closed Type)	700-1250	

*Please consult Murata regarding ultrasonic cleaning conditions to avoid possible damage during ultrasonic cleaning.

1

1 Characteristics and Types of CERALOCK®

MHz Band CERALOCK® with Built-in Load Capacitance (CSTLS Series)

As CSTLS series does not require externally mounted capacitors, the number of components can be reduced, allowing circuits to be made more compact.

The table shows the frequency range and appearance of the three terminal CERALOCK® with built-in load capacitance.

■ Part Numbers and Dimensions of CERALOCK® with Built-in Load Capacitance (CSTLS Series)

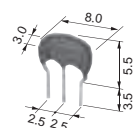
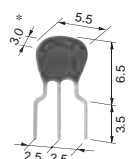
Part Number	Frequency	Dimensions (in mm)
CSTLS□□G	3.40–10.00MHz	
CSTLS□□X	16.00–70.00MHz	

* 16.00–32.99MHz : 3.5

■ Part Numbering

(Ex.)

CS	T	LS	4M00	G	5	3	□	-A0
①	②	③	④	⑤	⑥	⑦	⑧	⑨

- ① Product ID
- ② Frequency/Built-in Capacitance
- ③ Structure/Size
LS : Round Lead Type
- ④ Nominal Center Frequency
- ⑤ Type
G : Thickness Shear vibration,
X : Thickness Longitudinal Vibration (3rd overtone)
- ⑥ Frequency Tolerance
1 : ±0.1%, 2 : ±0.2%, 3 : ±0.3%, 5 : ±0.5%, D : DTMF,
Z : Others
- ⑦ Built-in Load capacitance
1 : 5pF, 3 : 15pF, 4 : 22pF, 5 : 30pF, 6 : 47pF
- ⑧ Individual Specification
With standard products, " ⑧ individual Specification" is omitted, and " ⑨ Package Specification Code" is carried up.
- ⑨ Packaging
-B0 : Bulk,
-A0 : Radial Taping H0=18mm Ammo Pack (Standard)

Characteristics and Types of CERALOCK® 1

Reflow Solderable kHz Band CERALOCK® (CSBFB Series)

Reflow solderable kHz band CERALOCK® (CSBFB series) have been developed to meet down sizing and S.M.T. (Surface Mount Technology) requirements.

Part Numbering



- ① Product ID
- ② Frequency/No capacitance built-in
- ③ Structure/Size
- ④ Nominal Center Frequency
- ⑤ Type
J : Area Expansion mode (Closed type)
- ⑥ Frequency Tolerance
2 : ±0.2%, 3 : ±0.3%, 5 : ±0.5%,
B : ±1kHz, C : ±2kHz, Z : Others
- ⑦ Load Capacitance Value
- ⑧ Individual Specification
With standard products, "⑧ individual Specification" is omitted, and "⑨ Package Specification Code" is carried up.
- ⑨ Packaging
-B0 : Bulk,
-R1 : Plastic Taping φ330mm Reel Package

Dimensions of Reflow Solderable CERALOCK® (CSBFB Series)

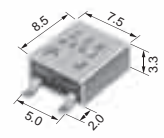
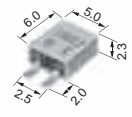
Part Number ^{*1}	Frequency (kHz)	Dimensions (in mm)
CSBFB□J	430-519	
CSBFB□J	700-1250 ^{*2}	

*1 Please consult Murata regarding ultrasonic cleaning conditions to avoid possible damage during Ultrasonic cleaning.
 *2 Not available for certain frequencies

Dimensions of Carrier Tape for CSBFB Series (430 to 519kHz Type)

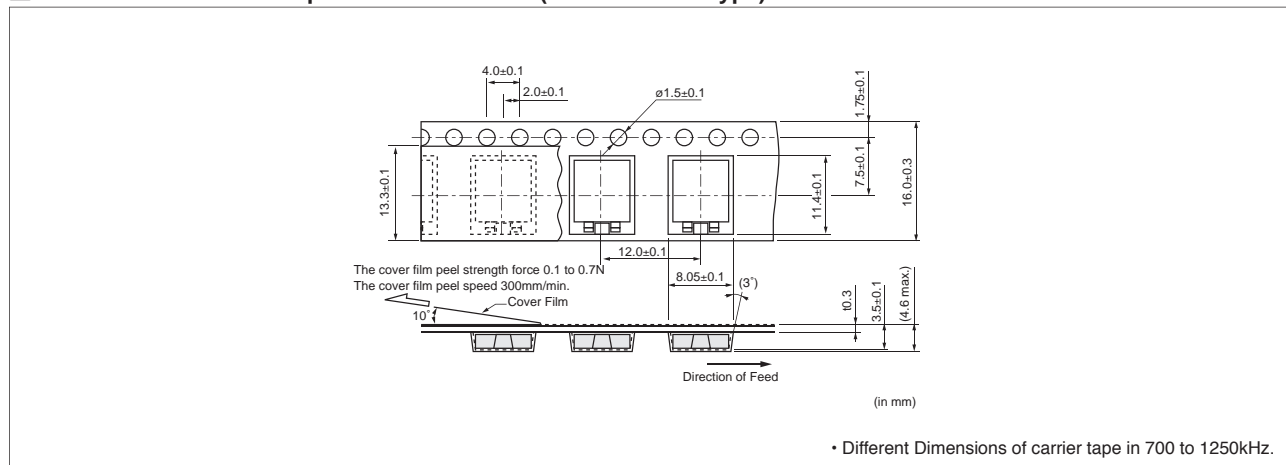

1

1 Characteristics and Types of CERALOCK®

MHz Band Chip CERALOCK® (CSACW/CSTCC/CSTCR/CSTCE/CSTCW Series)

The MHz band Chip CERALOCK® has a wide frequency range and small footprint to meet further down sizing and high-density mounting requirements.

The table shows the dimensions and two terminals standard land patterns of the CERALOCK® CSACW series.

The second table shows the dimensions and three terminals standard land patterns of CSTCC/CSTCR/CSTCE/CSTCW series chip resonator (built-in load capacitance type). And the carrier tape dimensions of CSTCR series are shown on the next page.

■ Dimensions and Standard Land Pattern of Chip CERALOCK® (CSACW Series)

Part Number	Frequency (MHz)	Dimensions Standard Land Pattern (in mm)
CSACW□□X	20.01-70.00	

*1 Thickness varies with frequency.

■ Part Numbering

(Ex.)

CS	T	CR	4M00	G	5	3	□	-R0
①	②	③	④	⑤	⑥	⑦	⑧	⑨

- ① Product ID
- ② Frequency/No capacitance built-in
A : No Capacitance Built-in, T : Built-in Capacitance
- ③ Structure/Size
CC/CR/CE : Cap Chip Type, CW : Monolithic Chip Type
- ④ Nominal Center Frequency
- ⑤ Type
G : Thickness Shear Vibration,
V : Thickness Longitudinal Vibration,
X : Thickness Longitudinal Vibration (3rd overtone)
- ⑥ Frequency Tolerance
1 : ±0.1%, 2 : ±0.2%, 3 : ±0.3%, 5 : ±0.5%, Z : Others
- ⑦ Load Capacitance Value
(In case of CSACW, value is for external capacitance of standard circuit)
1 : 5pF or 6pF, 2 : 10pF, 3 : 15pF, 5 : 33pF or 39pF,
6 : 47pF
- ⑧ Individual Specification
With standard products, " ⑧ individual Specification" is omitted, and " ⑨ Package Specification Code" is carried up.
- ⑨ Packaging
-B0 : Bulk,
-R0 : Plastic Taping φ180mm Reel Package

Characteristics and Types of CERALOCK® 1

■ Dimensions and Standard Land Pattern of Chip CERALOCK® (CSTCC/CSTCR/CSTCE/CSTCW Series)

Part Number	Frequency (MHz)	Dimensions Standard Land Pattern (in mm)
CSTCC □ G ^{*2}	2.00–3.99	
CSTCR □ G ^{*2}	4.00–7.99	
CSTCE □ G ^{*2}	8.00–13.99	
CSTCE □ V ^{*2}	14.00–20.00	
CSTCW □ X ^{*2}	20.01–70.00	

*1 Thickness varies with frequency
 *2 Conformal coating or washing of the components is not acceptable because they are not hermetically sealed.

■ Dimensions of Carrier Tape for Chip CERALOCK®

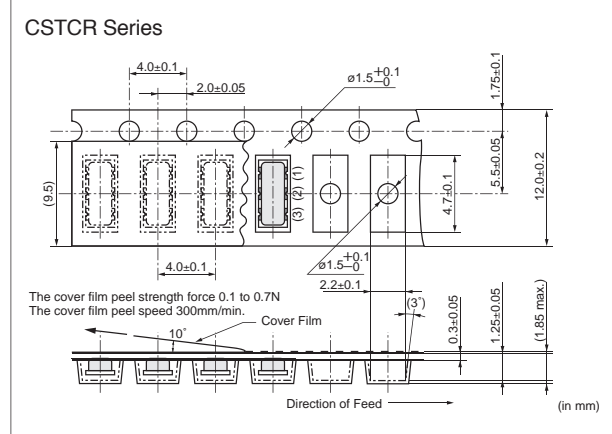

1

2 Principles of CERALOCK®

1. Equivalent Circuit Constants

Fig. 2-1 shows the symbol for a ceramic resonator. The impedance and phase characteristics measured between the terminals are shown in Fig. 2-2. This illustrates that the resonator becomes inductive in the frequency zone between the frequency F_r (resonant frequency), which provides the minimum impedance, and the frequency F_a (anti-resonant frequency), which provides the maximum impedance.

It becomes capacitive in other frequency zones. This means that the mechanical vibration of a two terminal resonator can be replaced equivalently with a combination of series and parallel resonant circuits consisting of an inductor : L, a capacitor : C, and a resistor : R. In the vicinity of the specific frequency (Refer to Note 1 on page 10.), the equivalent circuit can be expressed as shown in Fig. 2-3.

F_r and F_a frequencies are determined by the piezoelectric ceramic material and the physical parameters. The equivalent circuit constants can be determined from the following formulas. (Refer to Note 2 on page 10.)

$$F_r = 1/2\pi \sqrt{L_1 C_1} \quad (2-1)$$

$$F_a = 1/2\pi \sqrt{L_1 C_1 C_0 / (C_1 + C_0)} = F_r \sqrt{1 + C_1 / C_0} \quad (2-2)$$

$$Q_m = 1/2\pi F_r C_1 R_1 \quad (2-3)$$

(Q_m : Mechanical Q)

Considering the limited frequency range of $F_r \leq F \leq F_a$, the impedance is given as $Z = R_e + j\omega L_e$ ($L_e \geq 0$) as shown in Fig. 2-4, and CERALOCK® should work as an inductance L_e (H) having the loss R_e (Ω).

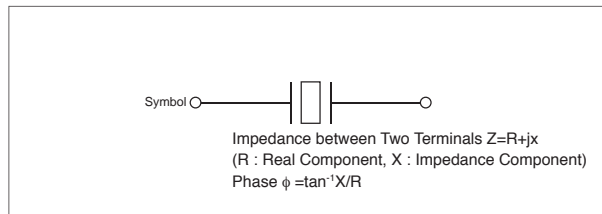

Fig. 2-1 Symbol of the Two Terminal CERALOCK®

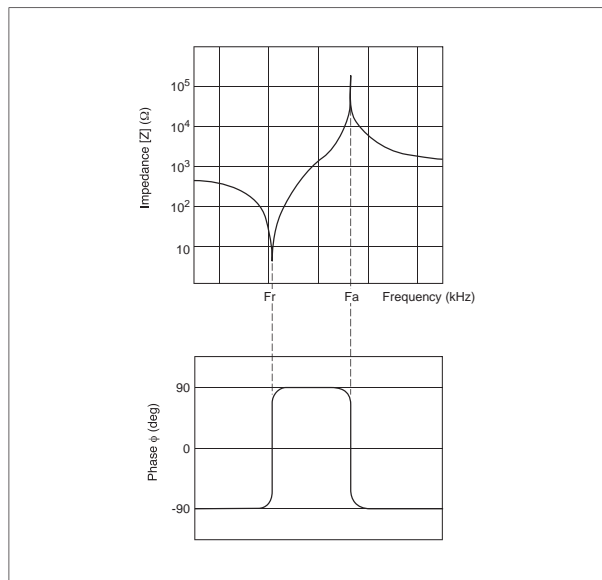

Fig. 2-2 Impedance and Phase Characteristics of CERALOCK®

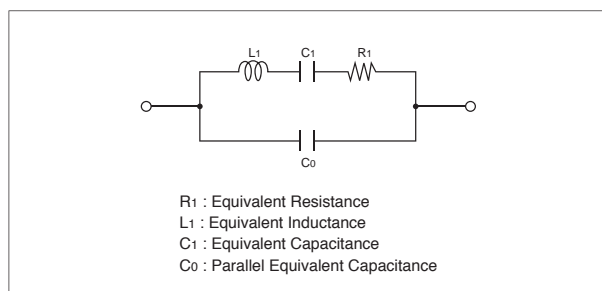

Fig. 2-3 Electrical Equivalent Circuit of CERALOCK®

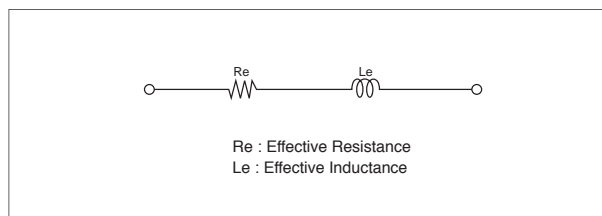

Fig. 2-4 Equivalent Circuit of CERALOCK® in the Frequency Band $F_r \leq F \leq F_a$

Principles of CERALOCK® 2

The table on this page shows comparison for the equivalent constants between CERALOCK® and quartz crystal oscillator.

In comparison, there is a large difference in capacitance and Qm, which results in the difference of oscillating conditions, when actually operated.

The table in the appendix shows the standard values of equivalent circuit constant for each type of CERALOCK®. Furthermore, other higher harmonic modes exist, other than the desired oscillation mode. These other oscillation modes exist because the ceramic resonator uses mechanical resonance.

Fig. 2-5 shows those characteristics.

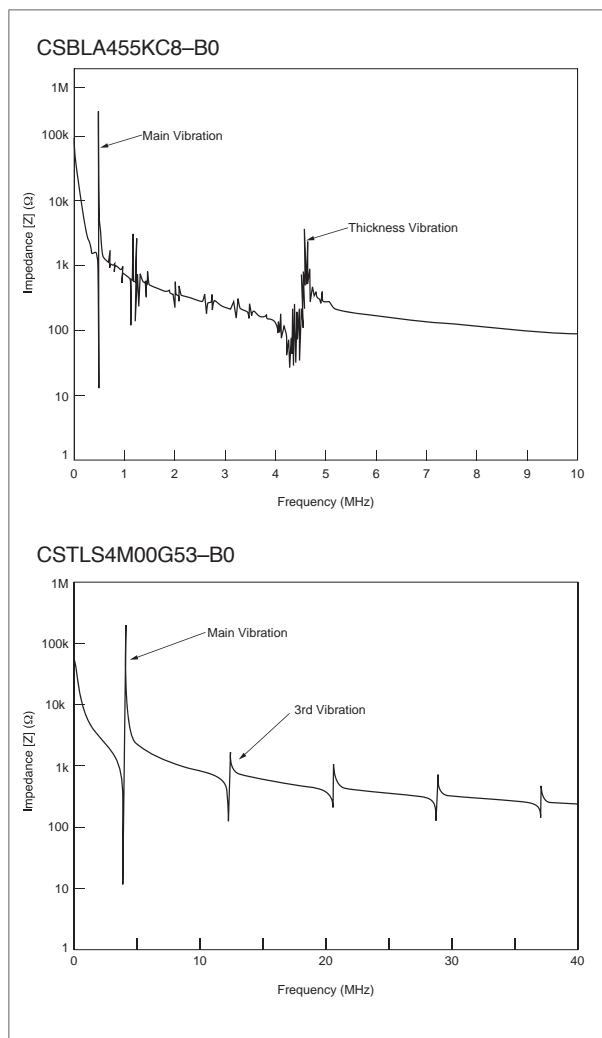

Fig. 2-5 Spurious Characteristics of CERALOCK®

■ Comparison of Equivalent Circuits of CERALOCK® and Crystal Oscillator

Resonator	Oscillation Frequency	L ₁ (μH)	C ₁ (pF)	C ₀ (pF)	R ₁ (Ω)	Q _m	dF (kHz)
CERALOCK®	455kHz	7.68×10 ³	16.7	272.8	10.1	2136	13
	2.00MHz	1.71×10 ³	4.0	20.8	43.9	475	177.2
	4.00MHz	0.46×10 ³	3.8	19.8	9.0	1220	350.9
	8.00MHz	0.13×10 ³	3.5	19.9	8.0	775	641.6
Crystal	453.5kHz	8.6 ×10 ⁶	0.015	5.15	1060	23000	0.6
	2.457MHz	7.2 ×10 ⁵	0.005	2.39	37.0	298869	3
	4.00MHz	2.1 ×10 ⁵	0.007	2.39	22.1	240986	6
	8.00MHz	1.4 ×10 ⁴	0.027	5.57	8.0	88677	19

2 Principles of CERALOCK®

2

Notes

(Note 1)

The relationship between the size of the resonator and the resonant frequency is described as follows. For example, the frequency doubles if the thickness doubles, when thickness vibration is used. The following relationship is obtained when the length of the resonators is ℓ , the resonance frequency is F_r , the speed of sound waves travelling through piezoelectric ceramics, and the wavelength is λ .

$$\left\{ \begin{array}{l} F_r \cdot \ell = \text{Const.} \\ \text{(frequency constant, } F_r \cdot t \text{ for the thickness)} \\ \lambda = 2 \ell \\ C = F_r \cdot \lambda = 2F_r \cdot \ell \end{array} \right.$$

As seen in the above formula, the frequency constant determines the size of the resonator.

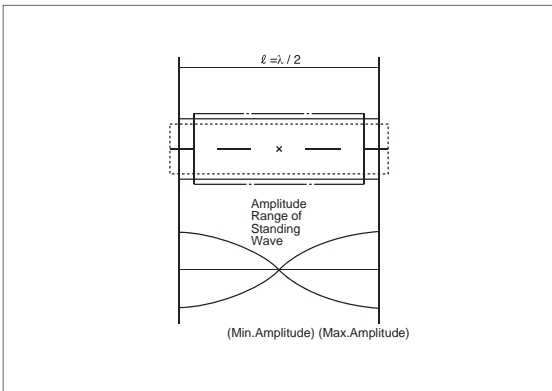

Fig. I

(Note 2)

In Fig. 2-3, when resistance R_1 is omitted for simplification, the impedance $Z(\omega)$ between two terminals is expressed by the following formula.

$$\begin{aligned} Z(\omega) &= \frac{\frac{1}{j\omega C_0} (j\omega L_1 + \frac{1}{j\omega C_1})}{\frac{1}{j\omega C_0} + (j\omega L_1 + \frac{1}{j\omega C_1})} \\ &= \frac{j(\omega L_1 - \frac{1}{\omega C_1})}{1 + \frac{C_0}{C_1} - \omega^2 C_0 L_1} \end{aligned}$$

When $\omega = \frac{1}{\sqrt{L_1 C_1}} = \omega_r$, $Z(\omega_r) = 0$

When $\omega = \frac{1}{\sqrt{C_0 C_1 L_1 / (C_0 + C_1)}} = \omega_a$, $Z(\omega_a) = \infty$

Therefore from $\omega = 2\pi F$,

$$F_r = \omega_r / 2\pi = \frac{1}{2\pi \sqrt{L_1 C_1}}$$

$$F_a = \omega_a / 2\pi = \frac{1}{2\pi \sqrt{C_0 C_1 L_1 / (C_0 + C_1)}} = F_r \sqrt{1 + \frac{C_1}{C_0}}$$

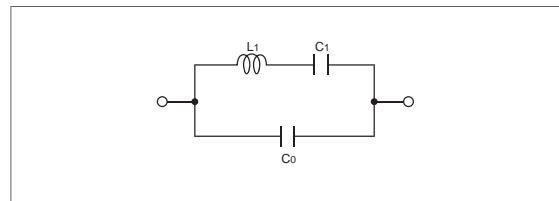

Fig. II

2. Basic Oscillation Circuits

Generally, basic oscillation circuits can be grouped into the following 3 categories.

- ① Use of positive feedback
- ② Use of negative resistance element
- ③ Use of delay in transfer time or phase

In the case of ceramic resonators, quartz crystal oscillators, and LC oscillators, positive feedback is the circuit of choice.

Among the positive feedback oscillation circuit using an LC, the tuning type anti-coupling oscillation circuit, Colpitts and Hartley circuits are typically used. See Fig. 2-6.

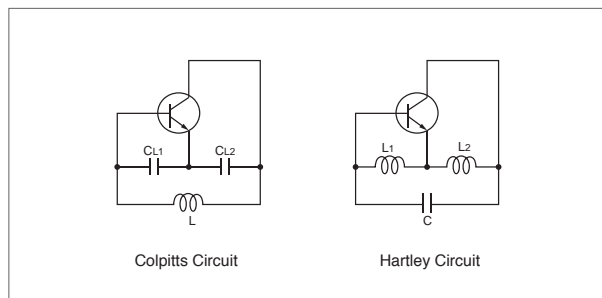

Fig. 2-6 Basic Configuration of LC Oscillation Circuit

In Fig. 2-6, a transistor, which is the most basic amplifier, is used.

The oscillation frequencies are approximately the same as the resonance frequency of the circuit consisting of L, CL1 and CL2 in the Colpitts circuit or consisting of L1 and L2 in the Hartley circuit. These frequencies can be represented by the following formulas. (Refer to Note 3 on page 13.)

(Colpitts Circuit)

$$f_{osc} \doteq \frac{1}{2\pi \sqrt{L \cdot \frac{C_{L1} \cdot C_{L2}}{C_{L1} + C_{L2}}}} \quad (2-4)$$

(Hartley Circuit)

$$f_{osc} \doteq \frac{1}{2\pi \sqrt{C (L_1 + L_2)}} \quad (2-5)$$

In an LC network, the inductor is replaced by a ceramic resonator, taking advantage of the fact that the resonator becomes inductive between resonant and anti-resonant frequencies.

This is most commonly used in the Colpitts circuit.

The operating principle of these oscillation circuits can be seen in Fig. 2-7. Oscillation occurs when the following conditions are satisfied.

$$\left\{ \begin{array}{l} \text{Loop Gain } G = \alpha \cdot \beta \geq 1 \\ \text{Phase Amount} \\ \theta = \theta_1 + \theta_2 = 360^\circ \times n \quad (n = 1, 2, \dots) \end{array} \right. \quad (2-6)$$

In Colpitts circuit, an inverter of $\theta_1 = 180^\circ$ is used, and it is inverted more than $\theta_2 = 180^\circ$ with L and C in the feedback circuit. The operation with a ceramic resonator can be considered the same.

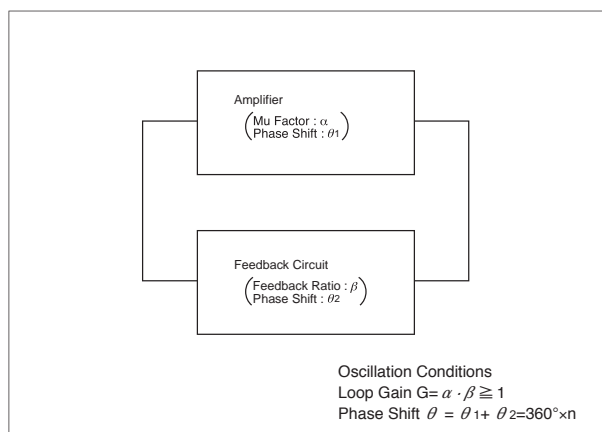

Fig. 2-7 Principle of Oscillation

2 Principles of CERALOCK®

It is general and simple to utilize inverter for Colpitts circuit with CERALOCK®.

Fig. 2-8 shows the basic oscillation circuit with inverter. In open loop circuit by cutting at ① point, it is possible to measure loop gain G and phase shift θ .

Fig. 2-9 shows the actual measuring circuit, and the example of measuring result is shown in Fig. 2-10.

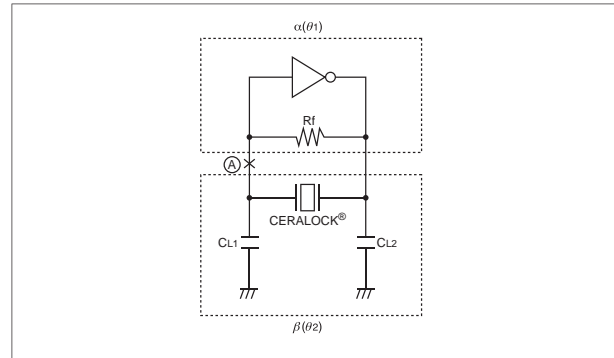

Fig. 2-8 Basic Oscillation Circuit with inverters

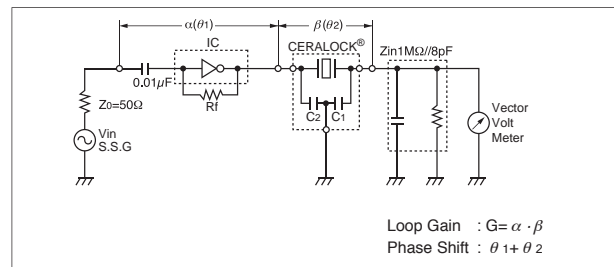

Fig. 2-9 Measuring Circuit Network of Loop Gain and Phase Shift

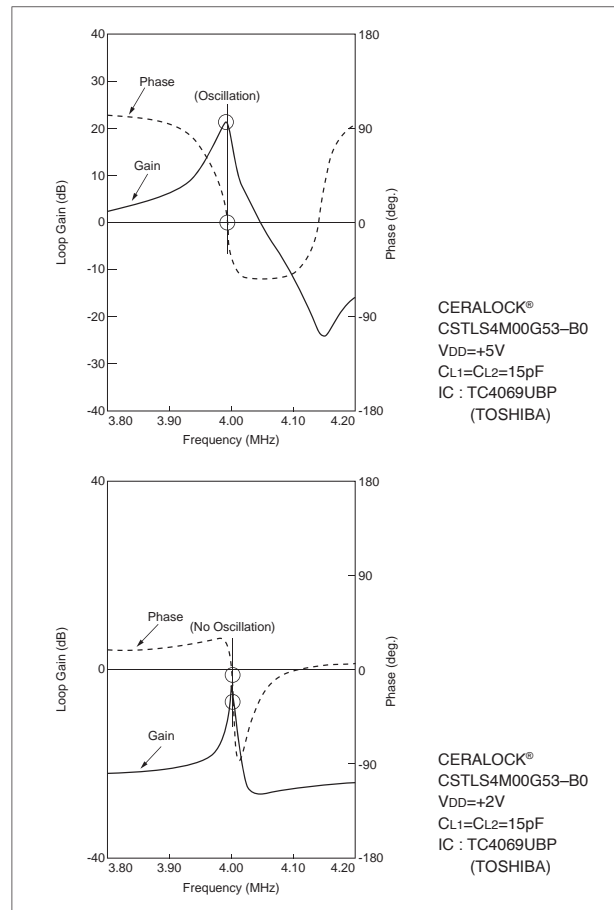

Fig. 2-10 Measured Results of Loop Gain and Phase Shift

Notes

(Note 3)

Fig. III shows the equivalent circuit of an emitter grounding type transistor circuit. In the figure, R_i stands for input impedance, R_o stands for output impedance and β stands for current amplification rate.

When the oscillation circuit in Fig. 2-6 is expressed by using the equivalent circuit in Fig. III, it becomes like Fig. IV. Z_1 , Z_2 and Z are as shown in the table for each Hartley type and Colpitts type circuit.

The following 3 formulas are obtained based on Fig. IV.

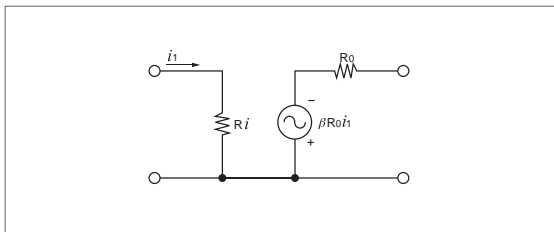
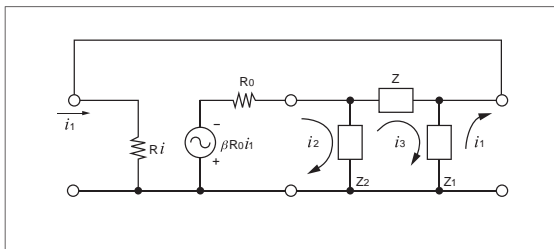

Fig. III



	Hartley Type	Colpitts Type
Z_1	$j\omega L_1$	$1 / j\omega C_{L1}$
Z_2	$j\omega L_2$	$1 / j\omega C_{L2}$
Z	$1 / j\omega C$	$j\omega L$

Fig. IV Hartley/Colpitts Type LC Oscillation Circuits

$$\begin{cases} \beta R_o i_1 + (R_o + Z_2) i_2 - Z_2 i_3 = 0 & \dots\dots\dots (1) \\ Z_1 i_1 + Z_2 i_2 - (Z_2 + Z + Z_1) i_3 = 0 & \dots\dots\dots (2) \\ (Z_1 + R_i) i_1 - Z_1 i_3 = 0 & \dots\dots\dots (3) \end{cases}$$

As $i_1 \neq 0$, $i_2 \neq 0$, $i_3 \neq 0$ are required for continuous oscillation, the following conditional formula can be performed by solving the formulas of (1), (2) and (3) on the current.

$$\begin{cases} \beta R_o Z_1 Z_2 = (Z_1 + R_i) Z_2^2 - \{Z_1 (Z_2 + Z) + \\ (Z_2 + Z + Z_1) R_i\} (Z_2 + R_o) & \dots\dots\dots (4) \end{cases}$$

Then, as Z_1 , Z_2 and Z are all imaginary numbers, the following conditional formula is obtained by dividing the formula (4) into the real number part and the imaginary number part.

$$\begin{cases} \text{(Imaginary number part)} \\ Z_1 Z_2 Z + (Z_1 + Z_2 + Z) R_i R_o = 0 & \dots\dots\dots (5) \end{cases}$$

$$\begin{cases} \text{(Real number part)} \\ \beta R_o Z_1 Z_2 + Z_1 (Z + Z_2) R_o + \\ Z_2 (Z + Z_1) R_i = 0 & \dots\dots\dots (6) \end{cases}$$

Formula (5) represents the phase condition and formula (6) represents the power condition. Oscillation frequency can be obtained by applying the elements shown in the aforementioned table to Z_1 , Z_2 and Z solving it for angular frequency ω .

(Hartley Type)

$$\omega^2_{osc} = (2\pi f_{osc})^2 = \frac{1}{(L_1 L_2) C \{1 + \frac{L_1 \cdot L_2}{(L_1 + L_2) C R_i R_o}\}} \dots\dots\dots (7)$$

(Colpitts Type)

$$\omega^2_{osc} = (2\pi f_{osc})^2 = \frac{1}{L \frac{C_{L1} \cdot C_{L2}}{C_{L1} + C_{L2}}} \cdot \{1 + \frac{L}{(C_{L1} + C_{L2}) R_i R_o}\} \dots\dots\dots (8)$$

In either circuit, the term in brackets will be 1 as long as R_i and R_o is large enough. Therefore oscillation frequency can be obtained by the following formula.

(Hartley Type) $f_{osc} \approx \frac{1}{2\pi \sqrt{(L_1 + L_2) C}} \dots\dots (9)$

(Colpitts Type) $f_{osc} \approx \frac{1}{2\pi \sqrt{L \cdot \frac{C_{L1} \cdot C_{L2}}{C_{L1} + C_{L2}}}} \dots\dots (10)$

3 Specifications of CERALOCK®

1. Electrical Specifications

The frequency stability of CERALOCK® is between that of crystal and LC or RC oscillators. Temperature stability is ± 0.3 to $\pm 0.5\%$ against initial values within -20 to $+80^\circ\text{C}$. The initial frequency precision is $\pm 0.5\%$ for standard products. The frequency of the standard CERALOCK® is adjusted by the standard measuring circuit, but the oscillation frequency may shift when used in the actual IC circuit. Usually, if the frequency precision needed for clock signal of a 1 chip microcomputer is approximately ± 2 to 3% under working conditions, CERALOCK® standard type can be used in most cases. If exact oscillation frequency is required for a special purpose, Murata can manufacture the ceramic resonator for the desired frequency. The following are the general electrical specifications of CERALOCK®. (As for the standard measuring circuit of oscillation frequency, please refer to the next chapter "Application to Typical Oscillation Circuits".)

Electrical Specifications of kHz Band CSBLA Series

Electrical specifications of CSBLA series are shown in the tables. The value of load capacitance ($CL1$, $CL2$) and damping resistance (Rd) depend on the frequency. (The initial frequency tolerance of standard CSBLA □ J type is $\pm 0.5\%$ max.)

Resonant Impedance Specifications of CSBLA Series

Frequency Range (kHz)	Resonant Impedance (Ω max.)
375– 450	20
451– 504	30
505– 799	40
800– 899	60
900–1099	100
1100–1250	120

Frequency Specifications of CSBLA Series

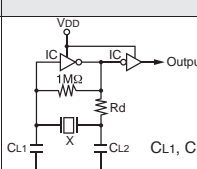
Item Part Number	Frequency (kHz)	Initial Tolerance of Oscillation Frequency	Temperature Stability of Oscillation Frequency (-20 to $+80^\circ\text{C}$)	Oscillating Frequency Aging	Standard Circuit for Oscillation Frequency
CSBLA Series (with MOS IC/ H-CMOS IC)	375–699	$\pm 2\text{kHz}$	$\pm 0.3\%$	$\pm 0.3\%$	 <p>IC : CD4069UBE(RCA) (MOS) : TC74HCU04(TOSHIBA) (H-CMOS) VDD : +5V X : CERALOCK® CL1, CL2, Rd : Depends on frequency (cf. Fig. 4-2, 4-3)</p>
	700–1250	$\pm 0.5\%$			

Specifications of CERALOCK® 3

Electrical Specifications of MHz Band Lead CERALOCK® (CSTLS Series)

Electrical specifications of CSTLS series are shown in the tables. Please note that oscillation frequency measuring circuit constants of the CSTLS □G56 series (with H-CMOS IC) depends on frequency.

MHz band three terminal CERALOCK® (CSTLS Series) is built-in load capacitance.

Fig. 3-1 shows the electrical equivalent circuit.

The table shows the general specifications of the CSTLS series. Input and output terminals of the three terminal CERALOCK® are shown in the table titled Dimensions of CERALOCK® CSTLS series in Chapter 1 on page 6. But connecting reverse, the oscillating characteristics are not affected except that the frequency has slight lag.

Resonant Impedance Specifications of CSTLS/ Series

Type	Frequency Range (MHz)	Resonant Impedance (Ω max.)
CSTLS □G	3.40 — 3.99	50
	4.00 — 7.99	30
	8.00 — 10.00	25
CSTLS □X	16.00 — 32.99	50
	33.00 — 60.00	40
	60.01 — 70.00	50

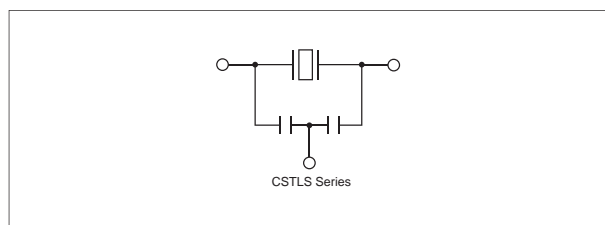

Fig. 3-1 Symbol of the Three Terminal CERALOCK®

General Specifications CSTLS Series

Part Number	Item	Frequency Range (MHz)	Initial Tolerance Of Oscillation Frequency	Temperature Stability of Oscillation Frequency (-20 to +80°C)	Oscillating Frequency Aging	Standard Circuit for Oscillation Frequency
CSTLS □G53/56		3.40—10.00	±0.5%	±0.2% ^{*1}	±0.2%	<p>IC : TC4069UBP^{*3} VDD : +5V X : CERALOCK® Rd : 680Ω^{*4}</p>
CSTLS □X		16.00—70.00	±0.5%	±0.2%	±0.2%	

*1 This value varies for built-in Capacitance

*2 If connected conversely, there may occur a little frequency lag.

*3 G56/X series : TC74HCU04(TOSHIBA), CSTLS series (50.00~70.00MHz) : SN74AHC04(TI)

*4 This resistance value applies to the CSTLS □G56 series.

3

3 Specifications of CERALOCK®

Electrical Specifications of MHz Band Chip CERALOCK® (CSACW Series) (CSTCC/CSTCR/CSTCE/CSTCW Series)

General specifications of chip CERALOCK® (CSACW series) (CSTCC/CSTCR/CSTCE/CSTCW series) are shown in the tables respectively.

Resonant Impedance of CSTCC/CSTCR/CSTCE/CST(A)CW Series

Type	Frequency Range (MHz)	Resonant Impedance (Ω max.)
CSTCC□G	2.00— 2.99	80
	3.00— 3.99	50
CSTCR□G	4.00— 5.99	60
	6.00— 7.99	50
CSTCE□G	8.00—10.00	40
	10.01—13.99	30
CSTCE□V	14.00—20.00	40
CSACW□X/CSTCW□X	20.01—24.99	80
	25.00—29.99	60
	30.00—60.00	50
	60.01—70.00	60

3

General Specifications of CSACW Series

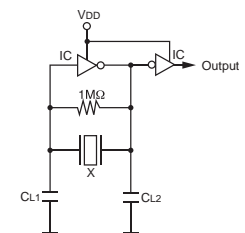
Part Number	Item	Frequency Range (MHz)	Initial Tolerance of Oscillation Frequency	Temperature Stability of Oscillation Frequency (-20 to +80°C)	Oscillating Frequency Aging	Standard Circuit for Oscillation Frequency
CSACW□X53		20.01—24.99	±0.5%	±0.2%	±0.1%	 <p>IC : TC74HCU04*(TOSHIBA) VDD : +5V X : Chip CERALOCK® CL1, CL2 : This value varies for frequency.</p>
CSACW□X51		25.00—70.00	±0.5%	±0.2%	±0.1%	

* X51 Series (50.00—70.00MHz); SN74AHC04

General Specifications of CSTCC/CSTCR/CSTCE/CSTCW Series

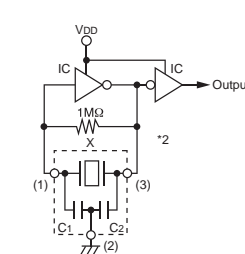
Part Number	Item	Frequency Range (MHz)	Initial Tolerance of Oscillation Frequency	Temperature Stability of Oscillation Frequency (-20 to +80°C)	Oscillating Frequency Aging	Standard Circuit for Oscillation Frequency
CSTCC□G		2.00— 3.99	±0.5%	±0.3% ^{1,3}	±0.3%	 <p>IC : TC4069UBP*(TOSHIBA) VDD : +5V X : Chip CERALOCK®</p>
CSTCR□G		4.00— 7.99	±0.5%	±0.2%	±0.1%	
CSTCE□G		8.00—13.99	±0.5%	±0.2%	±0.1%	
CSTCE□V		14.00—20.00	±0.5%	±0.3%	±0.3%	
CSTCW□X		20.01—70.00	±0.5%	±0.2%	±0.1%	

*1 V, X Series; TC74HCU04(TOSHIBA), X Series (50.00—70.00MHz); SN74AHC04(TI)

*2 If connected with wrong direction, above specification may not be guaranteed.

*3 This value varies for built-in Capacitance and Frequency.

Specifications of CERALOCK® 3

2. Mechanical and Environmental Specifications of CERALOCK®

The tables show the standard test conditions of mechanical strength and environmental specifications of CERALOCK®.

Fig. 3-2 shows the changes of oscillation frequency in each test, the table on the next page shows the criteria after the tests, and Fig. 3-3 shows the reflow soldering profile.

Test Conditions for Standard Reliability of CERALOCK®

Item	Conditions
1. Shock Resistance	Measure after dropping from a height of [a] cm to [b] floor surface 3 times.
2. Soldering Heat Resistance	Lead terminals are immersed up to 2.0 mm from the resonator's body in solder bath of [c], and then the resonator shall be measured after being placed in natural condition for 1 hour. ^{*1} Reflow profile show in Fig. 3-5 of heat stress is applied to the resonator, then being placed in natural condition for 1 hour, the resonator shall be measured. ^{*2}
3. Vibration Resistance	Measure after applying vibration of 10 to 55Hz amplitude of 2 mm to each of 3 directions, X, Y, Z.
4. Humidity Resistance	Keep in a chamber with temperature of [d] and humidity of 90 to 95% for [e] hours. Leave for 1 hour before measurement.
5. Storage at High Temperature	Keep in a chamber at 85±2°C for [e] hours. Leave for 1 hour before measurement.
6. Storage at Low Temperature	Keep in a chamber at [f] °C for [e] hours. Leave for 1 hour before measurement.
7. Temperature Cycling	Keep in a chamber at -55°C for 30 minutes. After leaving at room temperature for 15 minutes, keep in a chamber at +85°C for 30 minutes, and then room temperature for 15 minutes. After 10 cycles of above, measure at room temperature.
8. Terminal Strength	Apply 1 kg of static load vertically to each terminal and measure.

*1 Applies to CERALOCK® Lead Type

*2 Applies to MHz Band Chip CERALOCK®

1. CSBLA Series

Type	fosc.	a	b	c	d	e	f
J	700—1250kHz	100	concrete	350±10°C	60±2°C	1000	-55±2°C
E	375— 699kHz	75	concrete	350±10°C	40±2°C	500	-25±2°C

2. CSTLS Series

Type	fosc.	a	b	c	d	e	f
G	3.40—10.00MHz	100	concrete	350±10°C	60±2°C	1000	-55±2°C
X	16.00—70.00MHz	100	concrete	350±10°C	60±2°C	1000	-55±2°C

3. CSACW Series

Type	fosc.	a	b	c	d	e	f
X	20.01—70.00MHz	100	wooden plate	—	60±2°C	1000	-55±2°C

4. CSTCC/CSTCR/CSTCE/CSTCW Series

Type	fosc.	a	b	c	d	e	f
G	2.00—13.99MHz	100	wooden plate	—	60±2°C	1000	-55±2°C
V	14.00—20.00MHz	100	wooden plate	—	60±2°C	1000	-55±2°C
X	20.01—70.00MHz	100	wooden plate	—	60±2°C	1000	-55±2°C

3 Specifications of CERALOCK®

3

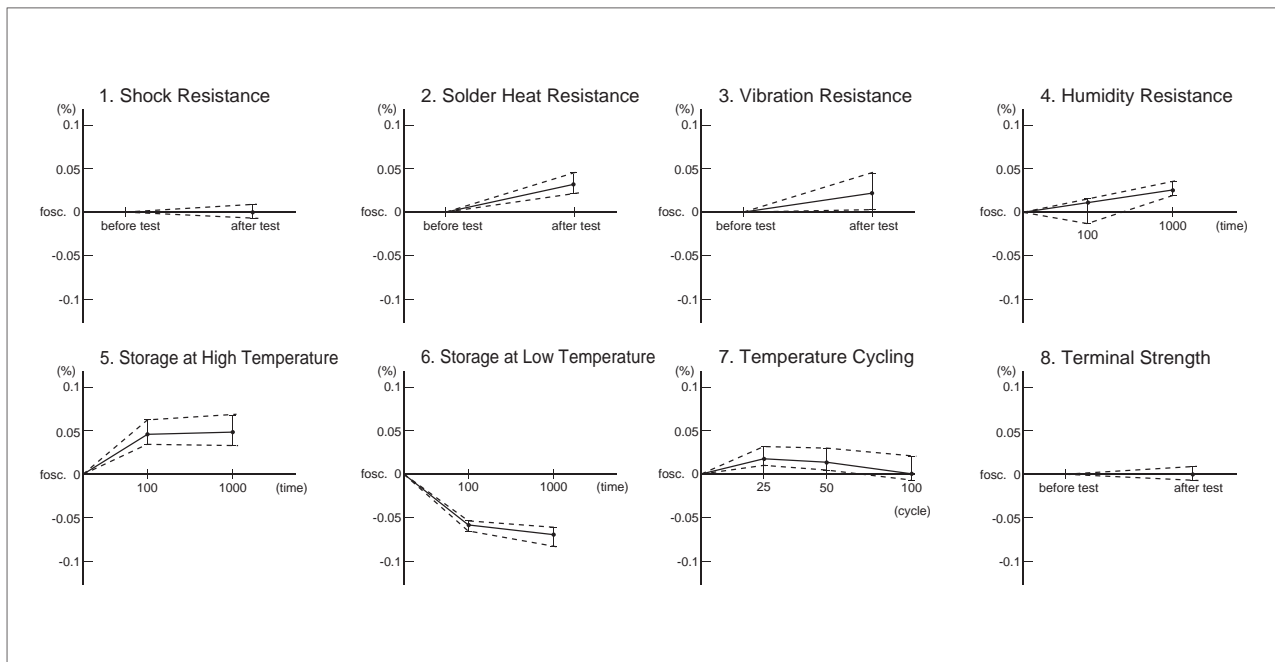

Fig. 3-2 General Changes of Oscillation Frequency in Each Reliability Test (CSTLS4M00G53-B0)

■ Deviation after Reliability Test

Type	Item	Oscillation Frequency	Others
Every Series		within $\pm 0.2\%$ (from initial value)	Meets the individual specification of each product.

* CSTCC Series : within $\pm 0.3\%$

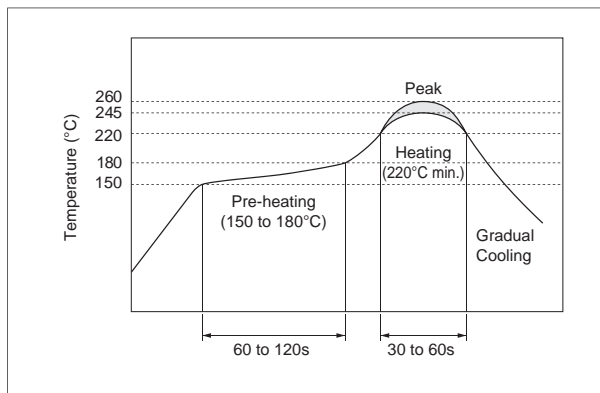

Fig. 3-3 Reflow Soldering Profile for MHz Band Chip CERALOCK®

4 Applications of Typical Oscillation Circuits

As described in Chapter 2, the most common oscillation circuit with CERALOCK® is to replace L of a Colpitts circuit with CERALOCK®. The design of the circuit varies with the application and the IC being used, etc. Although the basic configuration of the circuit is the same as that of a quartz crystal, the difference in mechanical Q results in the difference of the circuit constant.

This chapter briefly describes the characteristics of the oscillation circuit and gives some typical examples.

1. Cautions for Designing Oscillation Circuits

It is becoming more common to configure the oscillation circuit with a digital IC, and the simplest way to use an inverter gate.

Fig. 4-1 shows the configuration of a basic oscillation circuit with a C-MOS inverter.

INV. 1 works as an inverter amplifier of the oscillation circuit. INV. 2 acts to shape the waveform and also acts as a buffer for the connection of a frequency counter. The feedback resistance R_f provides negative feedback around the inverter in order to put it in the linear region, so the oscillation will start, when power is applied.

If the value of R_f is too large, and if the insulation resistance of the input inverter is accidentally decreased, oscillation will stop due to the loss of loop gain. Also, if R_f is too great, noise from other circuits can be introduced into the oscillation circuit.

Obviously, if R_f is too small, loop gain will be low. An R_f of $1M\Omega$ is generally used with a ceramic resonator. Damping resistor R_d provides loose coupling between the inverter and the feedback circuit and decreases the loading on the inverter, thus saving energy.

In addition, the damping resistor stabilizes the phase of the feedback circuit and provides a means of reducing the gain in the high frequency area, thus preventing the possibility of spurious oscillation.

Load capacitance C_{L1} and C_{L2} provide the phase lag of 180° .

The proper selected value depends on the application, the IC used, and the frequency. If C_{L1} and C_{L2} values are too low, the loop gain in the high frequency is increased, which in turn increases the probability of spurious oscillation.

This is particularly likely around 4 to 5 MHz, where the thickness vibration mode lies, as shown in Fig. 2-5 when using kHz band resonator.

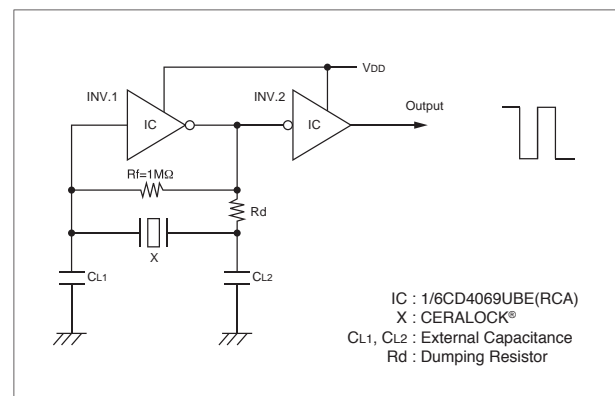

Fig. 4-1 Basic Oscillation Circuit with C-MOS Inverter

4 Application to Typical Oscillation Circuit

Oscillation frequency f_{osc} . in this circuit is expressed approximately by the following equation.

$$f_{osc} = Fr \sqrt{1 + \frac{C_1}{C_0 + C_L}} \quad (4-1)$$

Where, Fr=Resonance frequency of CERALOCK®

C_1 : Equivalent series capacitance of CERALOCK®

C_0 : Equivalent parallel capacitance of CERALOCK®

$$C_L = \frac{C_{L1} C_{L2}}{C_{L1} + C_{L2}}$$

This clearly shows that the oscillation frequency is influenced by the loading capacitance. And caution should be paid in defining its value when a tight tolerance of oscillation frequency is required.

4

2. Application to Various Oscillation Circuits

Application to C-MOS Inverter

For the C-MOS inverting amplifier, the one-stage 4069 C-MOS group is best suited.

The C-MOS 4049 type is not used, because the three-stage buffer type has excessive gain, which causes RC oscillation and ringing.

Murata employs the RCA (HARRIS) CD4069UBE as a C-MOS standard circuit. This circuit is shown in Fig. 4-2. The oscillation frequency of the standard CERALOCK® (C-MOS specifications) is adjusted by the circuit in Fig. 4-2.

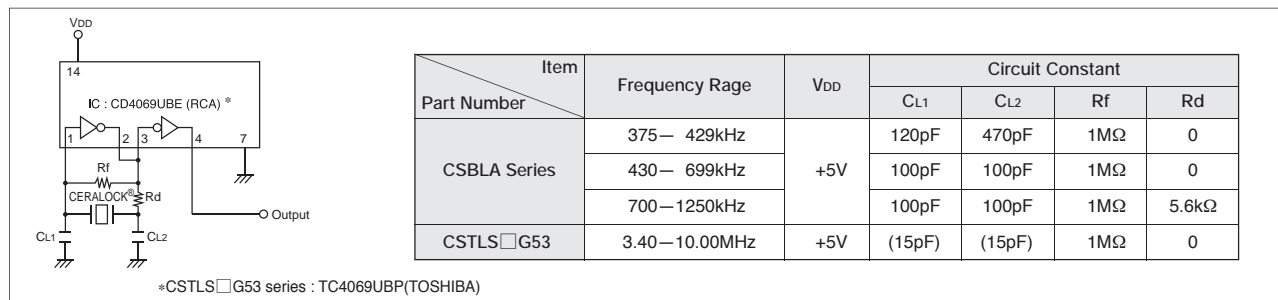

Fig. 4-2 C-MOS Standard Circuit

Application to Typical Oscillation Circuit **4**

Application to H-MOS Inverter

Recently, high speed C-MOS (H-CMOS) have been used more frequently for oscillation circuits allowing high speed and energy saving control for the microprocessor. There are two types of H-CMOS inverters: the unbuffered 74HCU series and the 74HC series with buffers.

The 74HCU system is optimum for the CERALOCK® oscillation circuit.

Fig. 4-3 shows our standard H-CMOS circuit.

Since H-CMOS has high gain, especially in the high frequency area, greater loading capacitor (CL) and damping resistor (Rd) should be employed to stabilize oscillation performance. As a standard circuit, we recommend Toshiba's TC74CU04, but any 74HCU04 inverter from other manufacturers may be used.

The oscillation frequency for H-CMOS specifications is adjusted by the circuit in Fig. 4-3.

4

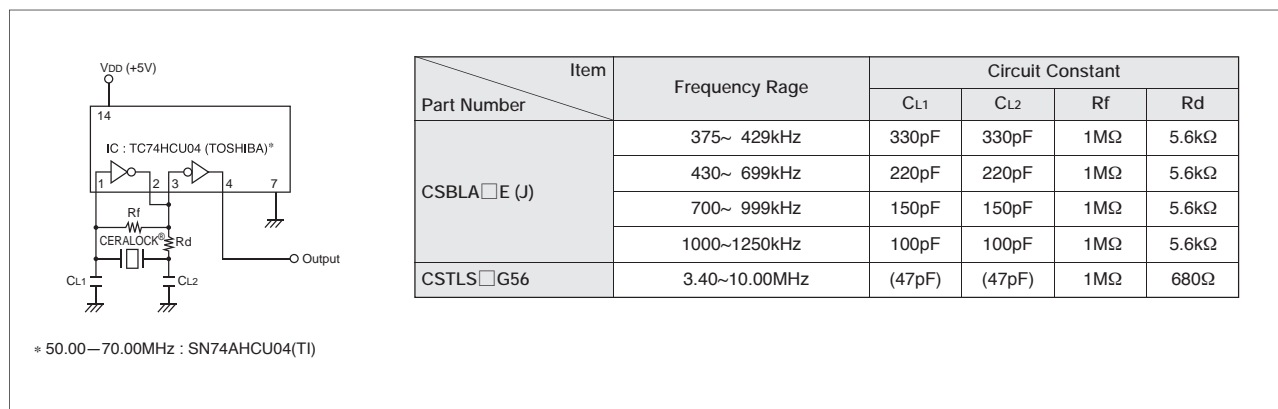

Fig. 4-3 H-CMOS Standard Circuit

5 Characteristics of CERALOCK® Oscillation Circuit

This chapter describes the general characteristics of the basic oscillation of Fig. 4-1 (page. 19). Contact Murata for detailed characteristics of oscillation with specific kinds of ICs and LSIs.

1. Stability of Oscillation Frequency

Fig. 5-1 shows examples of actual measurements for stability of the oscillation frequency.

The stability versus temperature change is ± 0.1 to 0.5% within a range of -20 to $+80^\circ\text{C}$, although varies slightly depending on the ceramic material.

Influence of load capacitance (C_{L1} , C_{L2}) on the oscillation frequency is relatively high, as seen in formula (4-1) (P.20).

It varies approximately $\pm 0.05\%$ for a capacitance deviation of $\pm 10\%$. The stability versus supply voltage is normally within $\pm 0.05\%$ in the working voltage range, although it varies with the characteristics of the IC.

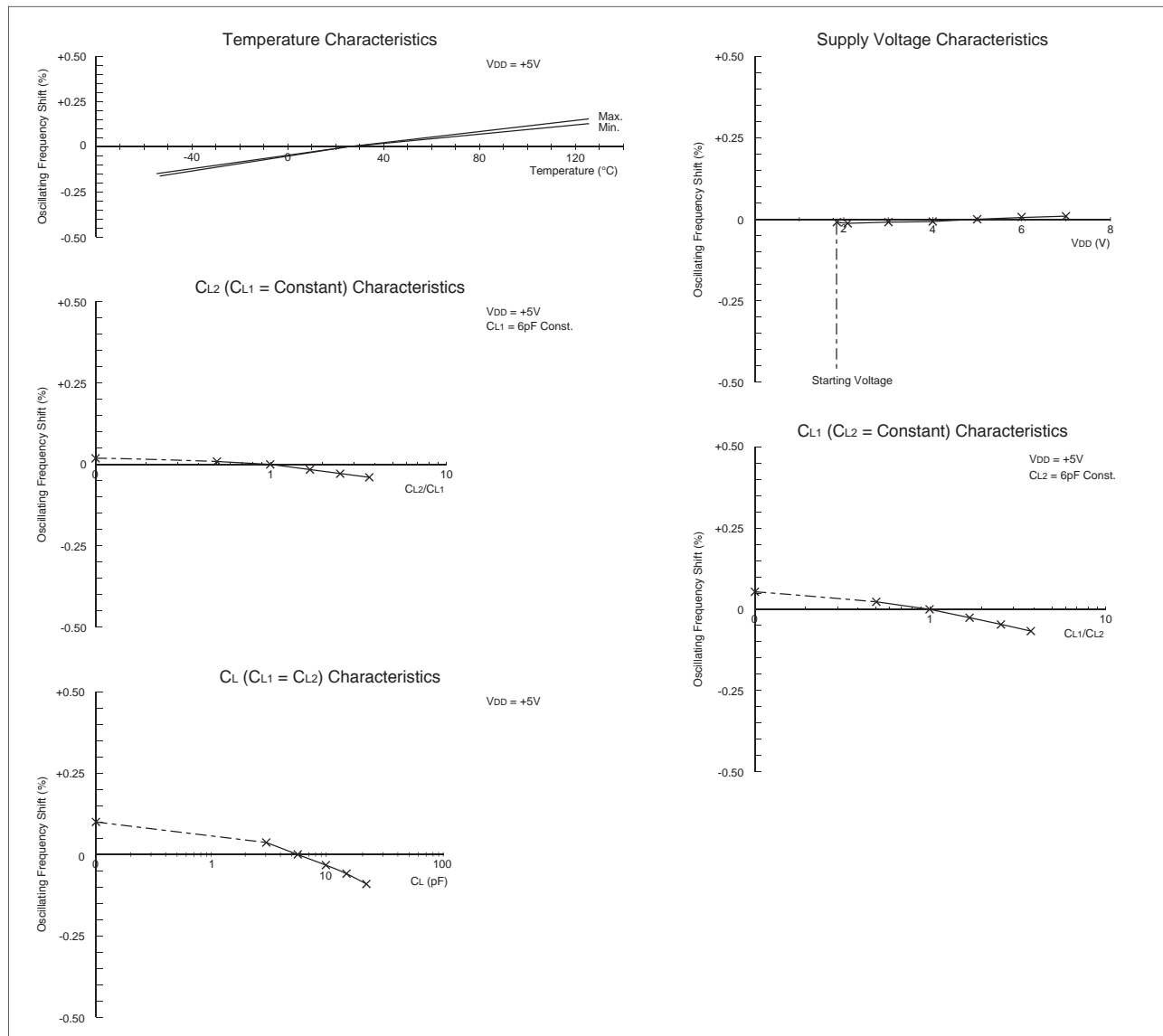

Fig. 5-1 Examples of Actual Measurement for the Stability of Oscillation Frequency (IC: TC74HCU04(TOSHIBA), CERALOCK®: CSACW33M8X51-B0)

Characteristics of CERALOCK® Oscillation Circuit 5

2. Characteristics of the Oscillation Level

Fig. 5-2 shows examples of actual measurements of the oscillation level versus temperature, supply voltage and load capacitance ($CL1$, $CL2$). The oscillating amplitude is required to be stable over a wide temperature range, and temperature characteristics should be as flat as possible. The graph titled Supply Voltage Characteristics in Fig. 5-2 shows that the amplitude varies linearly with supply voltage, unless the IC has an internal power supply voltage regulator.

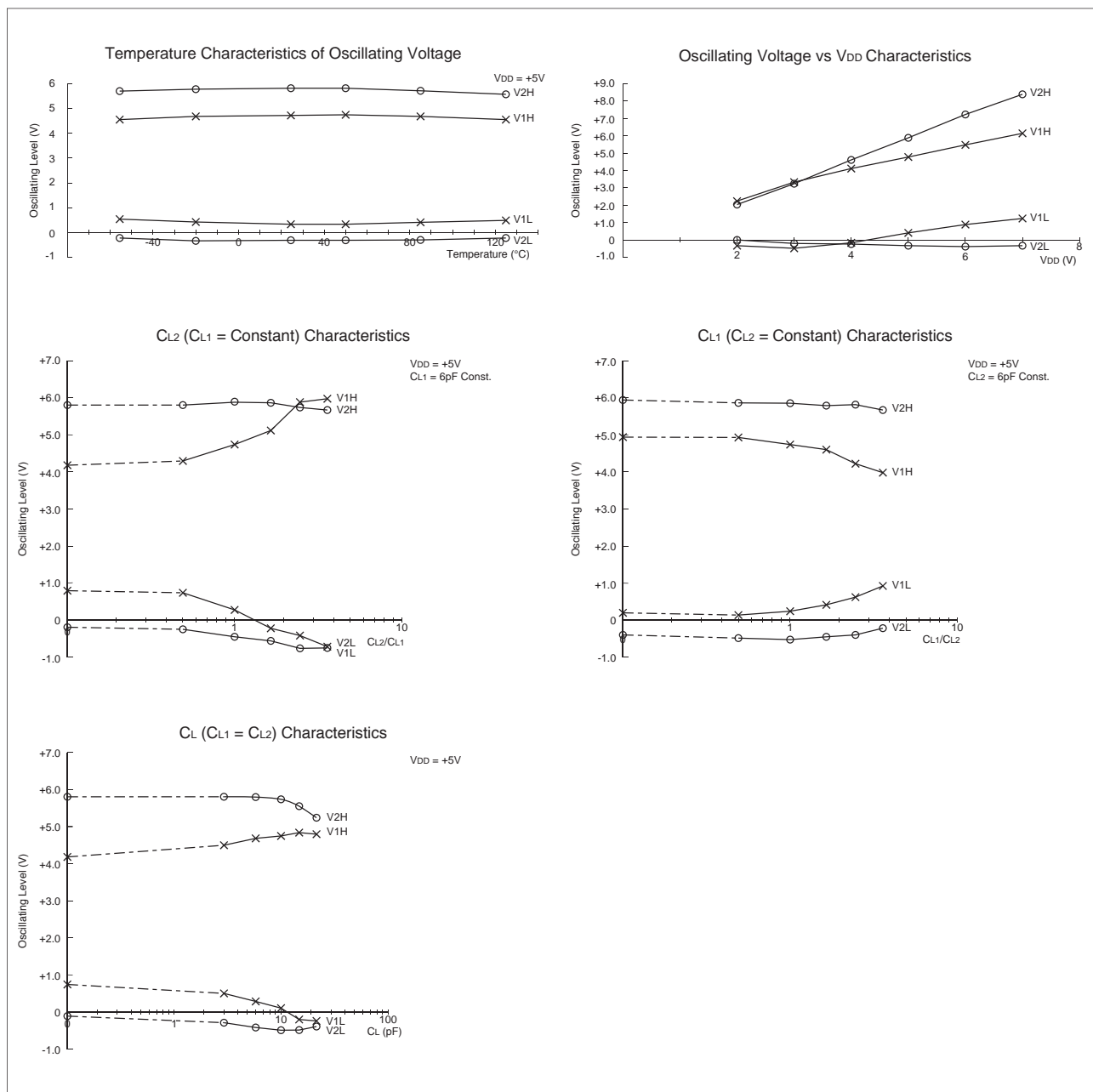

Fig. 5-2 Examples of Actual Measurement of Oscillating Amplitude (IC: TC74HCU04(TOSHIBA), CERALOCK®: CSACW33M8X51-B0)

5 Characteristics of CERALOCK® Oscillation Circuit

3. Characteristics of Oscillation Rise Time

Oscillation rise time means the time when oscillation develops from a transient area to a steady state condition, at the time the power of the IC is activated. With a CERALOCK®, this is defined as the time to reach 90% of the oscillation level under steady state conditions as shown in Fig. 5-3.

Rise time is primarily a function of the oscillation circuit design. Generally, smaller loading capacitance, higher frequency of ceramic resonator, and lower mechanical Q of ceramic resonator cause a faster rise time. The effect of load capacitance becomes more apparent as the capacitance of the resonator decreases.

Fig. 5-4 shows how the rise time increases as the load capacitance of the resonator increases. Also, Fig. 5-4 shows how the rise time varies with supply voltage. It is noteworthy that the rise time of the ceramic resonator is one or two decades faster than a quartz crystal.

Fig. 5-5 shows comparison of rise time between the two.

5

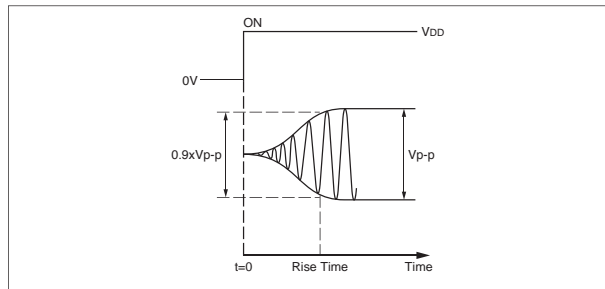

Fig. 5-3 Definition of Rise Time

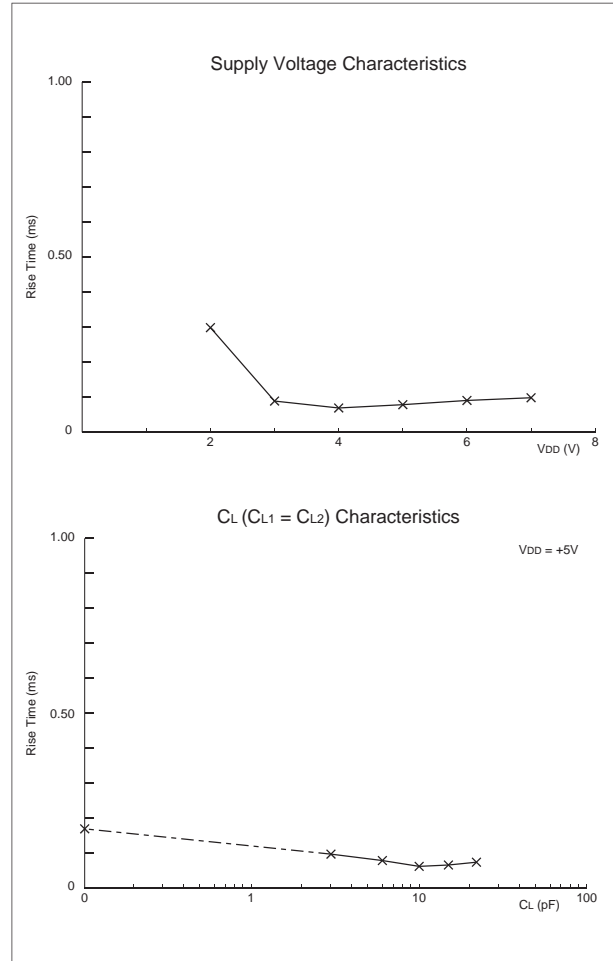

Fig. 5-4 Examples of Characteristics of Oscillation Rise Time (IC: TC74HCU04(TOSHIBA), CERALOCK®: CSACW33M8X51-B0)

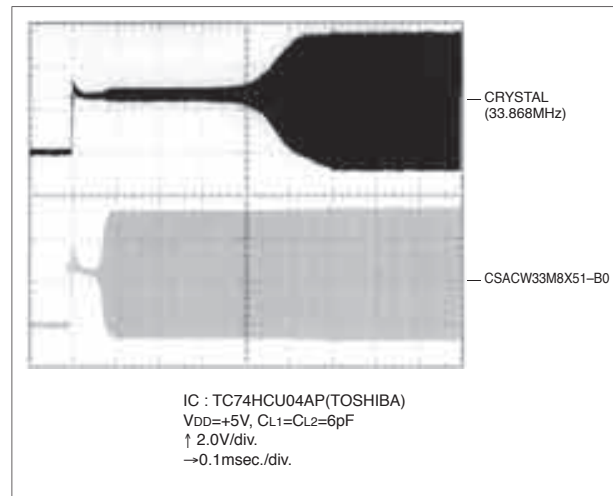

Fig. 5-5 Comparison of the Rise Time of a Ceramic Resonator vs. a Quartz Crystal

Characteristics of CERALOCK® Oscillation Circuit **5**

4. Starting Voltage

Starting voltage means the minimum supply voltage at which an oscillation circuit can operate. Starting voltage is affected by all the circuit elements, but it is determined mostly by the characteristics of the IC.

Fig. 5-6 shows an example of an actual measurement for the starting voltage characteristics against the loading capacitance.

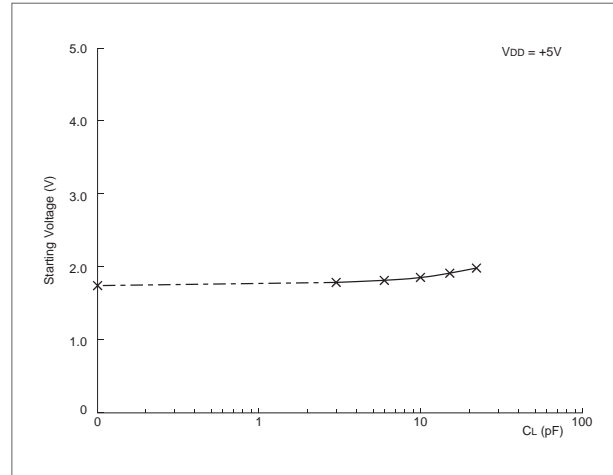

Fig. 5-6 Starting Voltage Characteristics against CL (CL1=CL2)
(IC: TC74HCU04(TOSHIBA), CERALOCK®:
CSACW33M8X51-B0)

6 Application Circuits to Various ICs/LSIs

CERALOCK®, by making good use of the above mentioned features, is used in a wide range of applications to various kinds of ICs. The following are a few examples of actual applications.

1. Application to Microcomputers

CERALOCK® is optimum for a stable oscillation element for various kinds of microcomputers : 4-bit, 8-bit and 16-bit.

With the general frequency tolerance required for the reference clock of microcomputers at ± 2 to $\pm 3\%$, standard CERALOCK® meets this requirement. Please consult with MURATA or LSI manufacturers about the circuit constants, because these constants vary with frequency and the LSI circuit being used.

Fig. 6-1 to 6-5 show applications to various kinds of 4-bit microcomputers, Fig. 6-6 to 6-8 show application to 8-bit microcomputers, and Fig. 6-9 to 6-10 show application to 16bit and 32bit microcomputers.

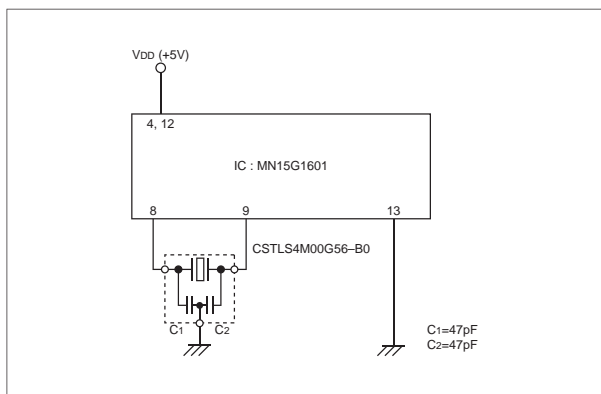

Fig. 6-1 Application to MN15G1601 (Panasonic)

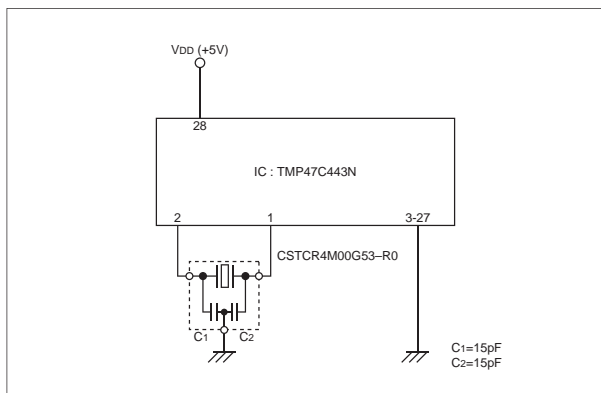

Fig. 6-2 Application to TMP47C443N (TOSHIBA)

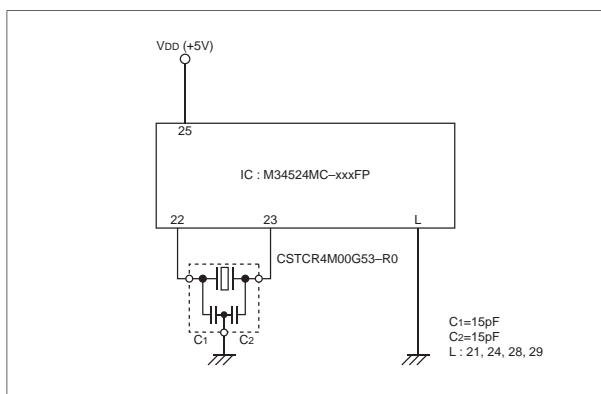

Fig. 6-3 Application to M34524MC-xxxFP (Renesas Electronics)

Application Circuits to Various ICs/LSIs **6**

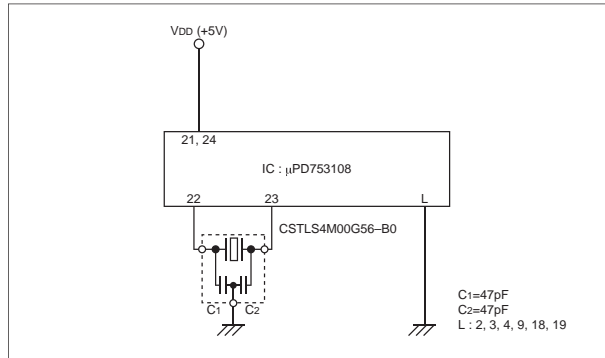

Fig. 6-4 Application to μ PD753108 (Renesas Electronics)

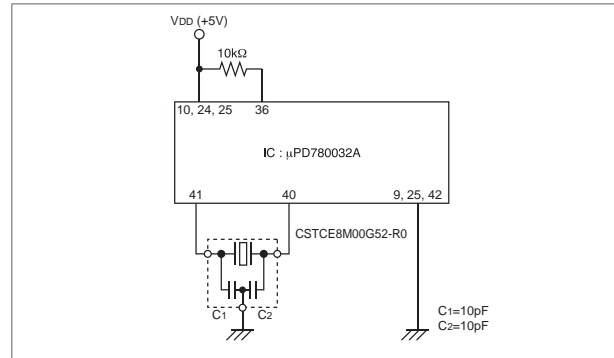

Fig. 6-7 Application to μ PD780032A (Renesas Electronics)

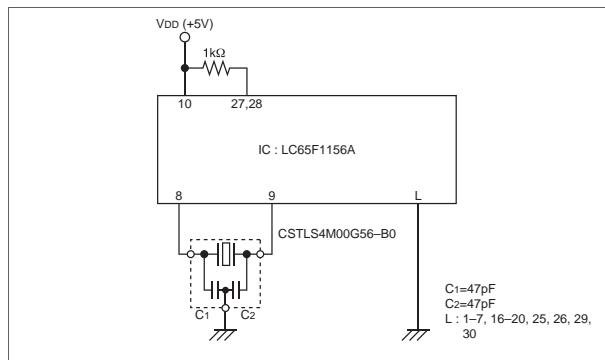

Fig. 6-5 Application to LC65F1156A (SANYO)

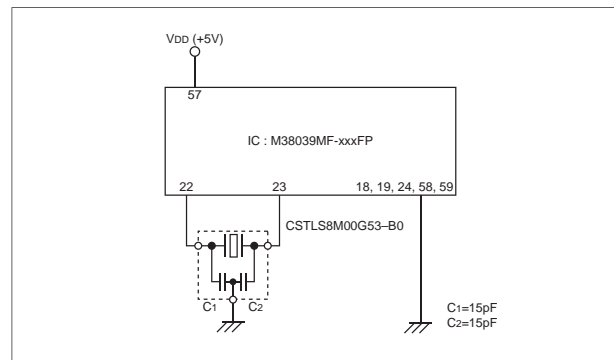

Fig. 6-8 Application to M38039MF-xxxFP (Renesas Electronics)

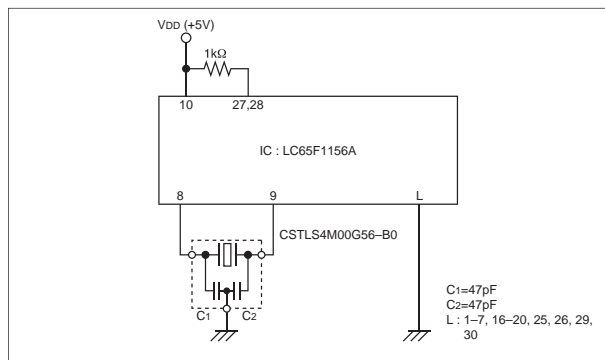

Fig. 6-6 Application to TMP87C809BN (TOSHIBA)

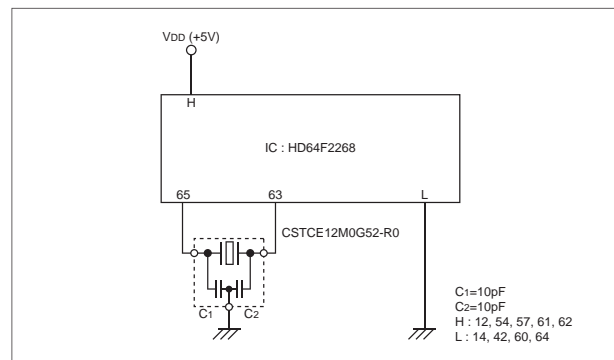

Fig. 6-9 Application to HD64F2268 (Renesas Electronics)

6 Application Circuits to Various ICs/LSIs

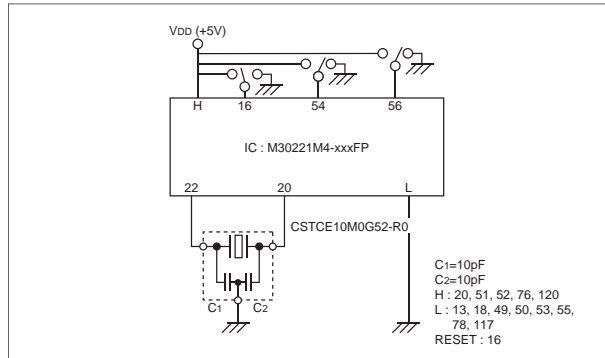

Fig. 6-10 Application to M30221M4-xxxFP
(Renesas Electronics)

Application Circuits to Various ICs/LSIs **6**

2. Application to Remote Control ICs

Remote controllers have become an increasingly more popular feature in TVs, stereos, VCRs, and air conditioners.

Fig. 6-11 shows example of CERALOCK® in remote control transmission ICs. Oscillation frequency is normally 3.2M to 4MHz, with 3.64MHz being the most popular. This 3.64MHz is divided by a carrier signal generator, so that a carrier of approximately 38kHz is generated.

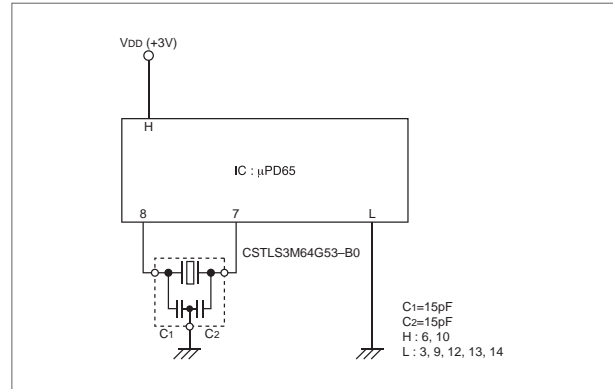

Fig. 6-11 Application to μPD65 (Renesas Electronics)

3. Application to ICs for Office Equipments

With the applications of ICs in office machines, many CERALOCK®s are used for motor drivers/controllers/digital signal processor (D.S.P.) in CD's ICs. Fig. 6-12 shows application example. It is believed that this type of application will increase in the future.

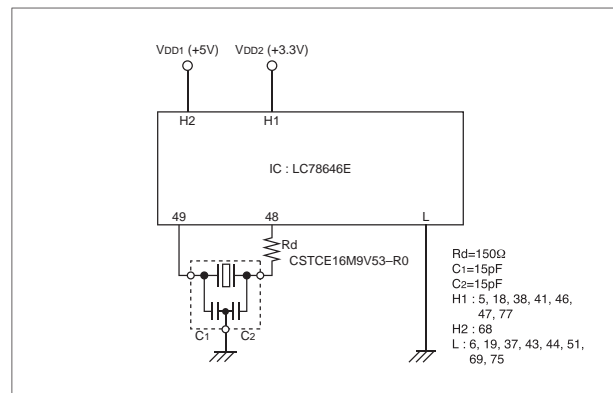

Fig. 6-12 Application to LC78646E (SANYO)
(CD Digital Signal Processor)

4. Other Kinds of Applications to Various ICs

Other than the above mentioned uses, CERALOCK® is widely used with ICs for voice synthesis.

Fig. 6-13 shows example of voice synthesis.

We can provide CERALOCK® application data for many ICs which are not mentioned in this manual. Please consult us for details.

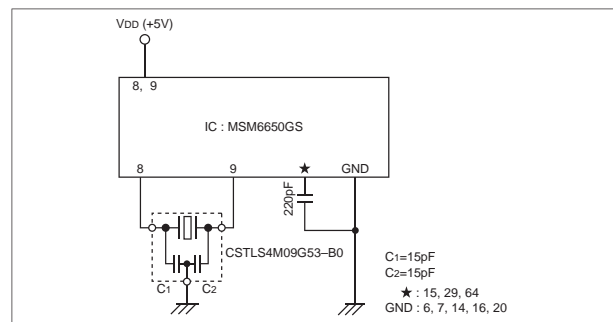

Fig. 6-13 Application to ICs for Voice Synthesis MSM6650GS (OKI)

6

7

Notice

■ Notice (Soldering and Mounting)

Please contact us regarding ultrasonic cleaning conditions to avoid possible damage during ultrasonic cleaning.

■ Notice (Storage and Operating Conditions)

- Please do not apply excess mechanical stress to the component and lead terminals at soldering.

■ Notice (Rating)

The component may be damaged if excess mechanical stress is applied.

■ Notice (Handling)

- Unstable oscillation or oscillation stoppage might happen when CERALOCK® is used in an improper way in conjunction with ICs. We are happy to evaluate the application circuit to avoid this for you.
- Oscillation frequency of our standard CERALOCK® is adjusted with our standard measuring circuit. There could be slight shift in frequency other types of IC are used. When you require exact oscillation frequency in your application, please contact us.

8

Appendix Equivalent Circuit Constants of CERALOCK®

(The equivalent circuit constants are not the guaranteed value but the standard value.)

Part Number	Equivalent Constant	Fr (kHz)	Fa (kHz)	ΔF (kHz)	R ₁ (Ω)	L ₁ (mH)	C ₁ (pF)	C ₀ (pF)	Q _m
CSBLA400KECE-B0		388.5	402.4	13.9	6.2	6.7041	25.0462	344.3647	2650
CSBLA455KEC8-B0		443.9	457.3	13.4	10.1	7.6800	16.7421	272.7610	2136
CSBLA500KEC8-B0		487.2	503.2	16.0	8.5	7.1632	14.9069	222.8248	2619
CSBLA600KEC8-B0		586.5	604.2	17.7	11.8	6.1860	11.9121	194.2629	2140
CSBLA700KJ58-B0		683.5	706.5	23.0	11.1	5.3876	10.0678	146.8621	2158
CSBLA1M00J58-B0		978.5	1013.3	34.7	13.7	4.4407	5.9576	82.4807	2009
CSBLA1M20J58-B0		1179.6	1220.8	41.2	45.4	4.5330	4.0184	56.4891	780
CSBLA456KE2ZF11-B0		436.6	457.9	21.2	11.4	4.1631	31.9247	320.3785	1006
CSBLA456KE2ZF14-B0		435.9	457.4	21.5	11.0	3.9472	33.7848	333.5176	989
CSBLA500KECZF02-B0		506.1	549.8	43.7	8.5	1.3209	74.8959	415.5858	496
CSBLA500KECZF09-B0		489.0	543.9	55.0	27.9	0.9089	116.5686	490.9133	100
CSBLA503KECZF02-B0		509.5	554.0	44.6	8.5	1.2460	78.3331	429.0170	474
CSTLS4M00G53-B0		3784.4	4135.3	350.9	9.0	0.4611	3.8377	19.7730	1220
CSTLS6M00G53-B0		5710.9	6199.5	488.6	7.5	0.2381	3.2635	18.2899	1135
CSTLS8M00G53-B0		7604.7	8246.3	641.6	8.0	0.1251	3.5030	19.9175	775
CSTLS10M0G53-B0		9690.1	10399.1	709.0	7.0	0.0984	2.7448	18.0899	947
CSTLS16M0X55-B0		15972.9	16075.0	102.1	24.6	0.6572	0.1511	11.7835	2681
CSTLS20M0X53-B0		19959.2	20070.8	111.6	19.0	0.4858	0.1309	11.6716	3203
CSTLS24M0X53-B0		23955.8	24095.9	140.2	16.6	0.4205	0.1050	8.9440	3805
CSTLS27M0X51-B0		27024.3	27172.8	148.5	15.9	0.3638	0.0953	8.6486	3877
CSTLS32M0X51-B0		31918.4	32092.6	174.2	13.4	0.2481	0.1002	9.1542	3716
CSTLS33M8X51-B0		33777.8	33969.7	191.9	25.6	0.2561	0.0867	7.6093	2120
CSTLS36M0X51-B0		36033.6	36241.1	207.6	13.4	0.2260	0.0863	7.4700	3821
CSTLS40M0X51-B0		39997.7	40240.1	242.7	15.8	0.2301	0.0688	5.6544	3651
CSTLS50M0X51-B0		49946.3	50193.1	246.8	27.6	0.1856	0.0547	5.5234	2107

⚠ **Note:**

1. Export Control

<For customers outside Japan>

No Murata products should be used or sold, through any channels, for use in the design, development, production, utilization, maintenance or operation of, or otherwise contribution to (1) any weapons (Weapons of Mass Destruction [nuclear, chemical or biological weapons or missiles] or conventional weapons) or (2) goods or systems specially designed or intended for military end-use or utilization by military end-users.

<For customers in Japan>

For products which are controlled items subject to the "Foreign Exchange and Foreign Trade Law" of Japan, the export license specified by the law is required for export.

2. Please contact our sales representatives or product engineers before using the products in this catalog for the applications listed below, which require especially high reliability for the prevention of defects which might directly damage a third party's life, body or property, or when one of our products is intended for use in applications other than those specified in this catalog.

- | | |
|-----------------------------|--|
| ① Aircraft equipment | ② Aerospace equipment |
| ③ Undersea equipment | ④ Power plant equipment |
| ⑤ Medical equipment | ⑥ Transportation equipment (vehicles, trains, ships, etc.) |
| ⑦ Traffic signal equipment | ⑧ Disaster prevention / crime prevention equipment |
| ⑨ Data-processing equipment | ⑩ Application of similar complexity and/or reliability requirements to the applications listed above |

3. Product specifications in this catalog are as of July 2010. They are subject to change or our products in it may be discontinued without advance notice. Please check with our sales representatives or product engineers before ordering. If there are any questions, please contact our sales representatives or product engineers.

4. Please read rating and ⚠ CAUTION (for storage, operating, rating, soldering, mounting and handling) in this catalog to prevent smoking and/or burning, etc.

5. This catalog has only typical specifications because there is no space for detailed specifications. Therefore, please approve our product specifications or transact the approval sheet for product specifications before ordering.

6. Please note that unless otherwise specified, we shall assume no responsibility whatsoever for any conflict or dispute that may occur in connection with the effect of our and/or a third party's intellectual property rights and other related rights in consideration of your use of our products and/or information described or contained in our catalogs. In this connection, no representation shall be made to the effect that any third parties are authorized to use the rights mentioned above under licenses without our consent.

7. No ozone depleting substances (ODS) under the Montreal Protocol are used in our manufacturing process.



<http://www.murata.com/>

Head Office

1-10-1, Higashi Kotari, Nagaokakyo-shi, Kyoto 617-8555, Japan
Phone: 81-75-951-9111

International Division

3-29-12, Shibuya, Shibuya-ku, Tokyo 150-0002, Japan
Phone: 81-3-5469-6123 Fax: 81-3-5469-6155 E-mail: intl@murata.co.jp