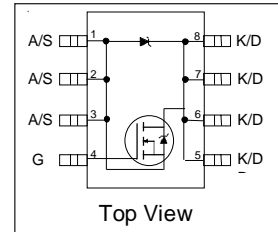
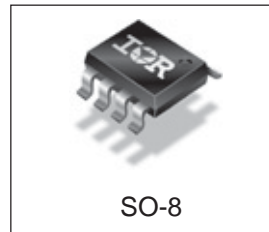


# IRF7807D2PbF

## FETKY™ MOSFET / SCHOTTKY DIODE

- Co-Pack N-channel HEXFET® Power MOSFET and Schottky Diode
- Ideal for Synchronous Rectifiers in DC-DC Converters up to 5A Output
- Low Conduction Losses
- Low Switching Losses
- Low Vf Schottky Rectifier
- Lead-Free



### Description

The FETKY™ family of Co-Pack HEXFET® MOSFETs and Schottky diodes offers the designer an innovative, board space saving solution for switching regulator and power management applications. HEXFET power MOSFETs utilize advanced processing techniques to achieve extremely low on-resistance per silicon area. Combining this technology with International Rectifier's low forward drop Schottky rectifiers results in an extremely efficient device suitable for use in a wide variety of portable electronics applications.

The SO-8 has been modified through a customized leadframe for enhanced thermal characteristics. The SO-8 package is designed for vapor phase, infrared or wave soldering techniques.

### Device Features (Max Values)

	IRF7807D2
$V_{DS}$	30V
$R_{DS(on)}$	25mΩ
$Q_g$	14nC
$Q_{SW}$	5.2nC
$Q_{OSS}$	21.6nC

### Absolute Maximum Ratings

Parameter	Symbol	Max.	Units
Drain-Source Voltage	$V_{DS}$	30	V
Gate-Source Voltage	$V_{GS}$	±12	
Continuous Drain or Source Current ( $V_{GS} \geq 4.5V$ )	$I_D$	25°C	8.3
		70°C	6.6
Pulsed Drain Current <sup>①</sup>	$I_{DM}$	66	A
Power Dissipation	$P_D$	25°C	2.5
		70°C	1.6
Schottky and Body Diode	$I_F (AV)$	25°C	3.7
Average Forward Current <sup>②</sup>		70°C	2.3
Junction & Storage Temperature Range	$T_J, T_{STG}$	-55 to 150	°C

### Thermal Resistance

Parameter	Symbol	Max.	Units
Maximum Junction-to-Ambient <sup>③</sup>	$R_{\theta JA}$	50	°C/W

www.irf.com

1  
10/7/04

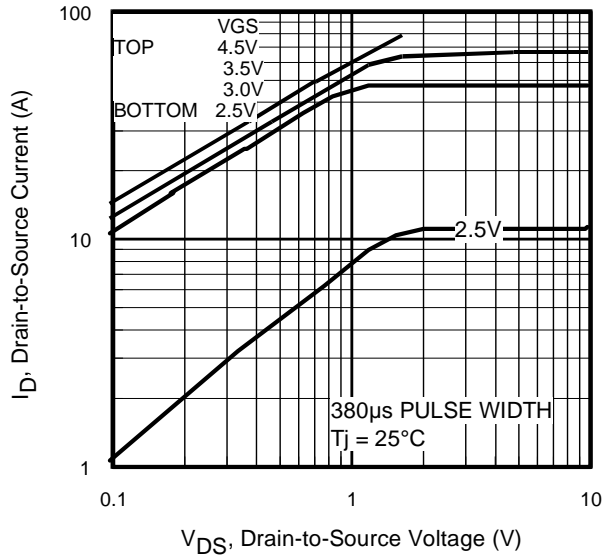
## Electrical Characteristics

Parameter		Min	Typ	Max	Units	Conditions
Drain-to-Source Breakdown Voltage*	$V_{(BR)DSS}$	30			V	$V_{GS} = 0V, I_D = 250\mu A$
Static Drain-Source on Resistance*	$R_{DS(on)}$		17	25	m $\Omega$	$V_{GS} = 4.5V, I_D = 7A$ ②
Gate Threshold Voltage*	$V_{GS(th)}$	1.0			V	$V_{DS} = V_{GS}, I_D = 250\mu A$
Drain-Source Leakage Current*	$I_{DSS}$			90	$\mu A$	$V_{DS} = 24V, V_{GS} = 0V$
				7.2	mA	$V_{DS} = 24V, V_{GS} = 0V, T_j = 125^\circ C$
Gate-Source Leakage Current*	$I_{GSS}$			+/- 100	nA	$V_{GS} = +/-12V$
Total Gate Charge Synch FET*	$Q_{gsync}$		10.5	14	nC	$V_{DS} < 100mV, V_{GS} = 5V, I_D = 7A$
Total Gate Charge Control FET*	$Q_{gcont}$		12	17		$V_{DS} = 16V, V_{GS} = 5V, I_D = 7A$
Pre-Vth Gate-Source Charge	$Q_{gs1}$		2.1			$V_{DS} = 16V, I_D = 7A$
Post-Vth Gate-Source Charge	$Q_{gs2}$		0.76			
Gate to Drain Charge	$Q_{gd}$		2.9			
Switch Charge* ( $Q_{gs2} + Q_{gd}$ )	$Q_{SW}$		3.66	5.2		
Output Charge*	$Q_{oss}$		17.6	21.6		$V_{DS} = 16V, V_{GS} = 0$
Gate Resistance	$R_g$		1.2			$\Omega$

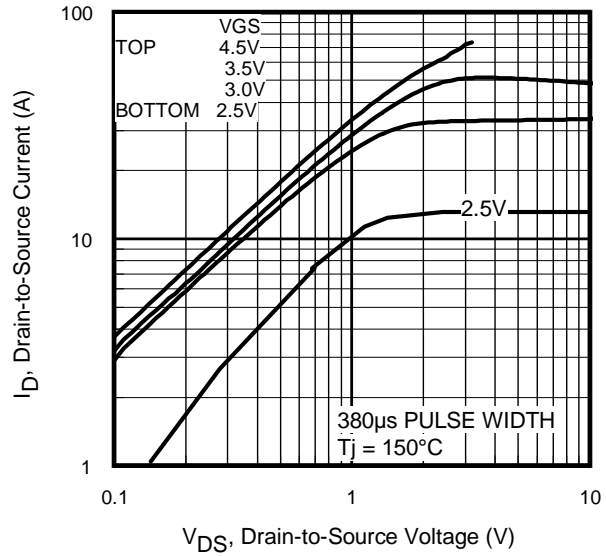
## Schottky Diode & Body Diode Ratings and Characteristics

Parameter		Min	Typ	Max	Units	Conditions
Diode Forward Voltage	$V_{SD}$			0.54	V	$T_j = 25^\circ C, I_s = 3A, V_{GS} = 0V$ ②
				0.43		$T_j = 125^\circ C, I_s = 3A, V_{GS} = 0V$ ②
Reverse Recovery Time	$t_{rr}$		36		ns	$T_j = 25^\circ C, I_s = 7.0A, V_{DS} = 16V$
Reverse Recovery Charge	$Q_{rr}$		41		nC	$di/dt = 100A/\mu s$
Forward Turn-On Time	$t_{on}$	Intrinsic turn-on time is negligible (turn-on is dominated by $L_s + L_D$ )				

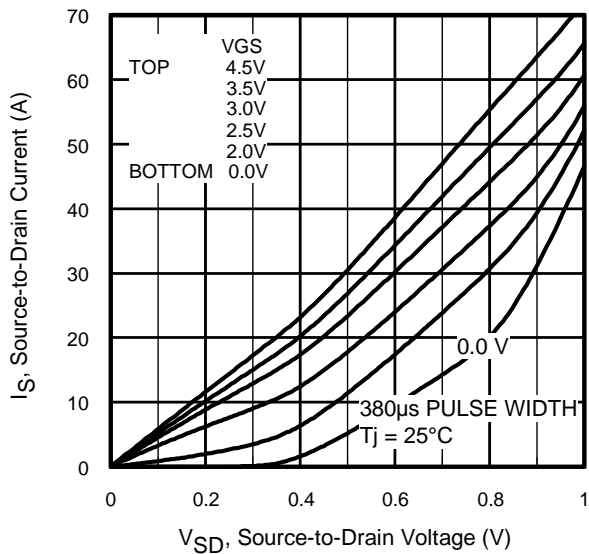
- ① Repetitive rating; pulse width limited by max. junction temperature.  
 ② Pulse width  $\leq 300 \mu s$ ; duty cycle  $\leq 2\%$ .  
 ③ When mounted on 1 inch square copper board,  $t < 10$  sec.  
 ④ 50% Duty Cycle, Rectangular  
 \* Devices are 100% tested to these parameters.



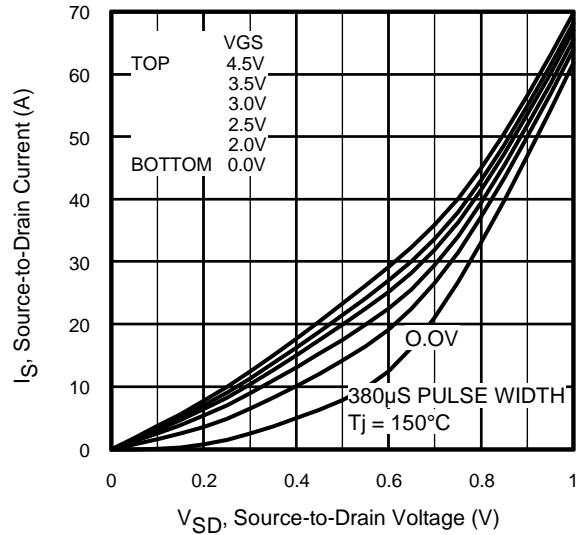
**Fig 1.** Typical Output Characteristics



**Fig 2.** Typical Output Characteristics

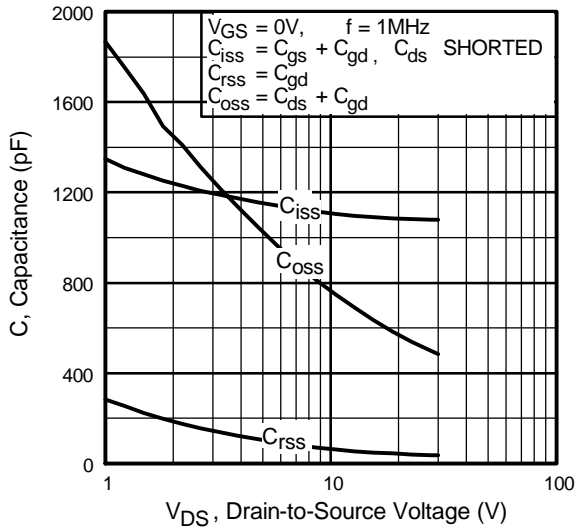


**Fig 3.** Typical Reverse Output Characteristics

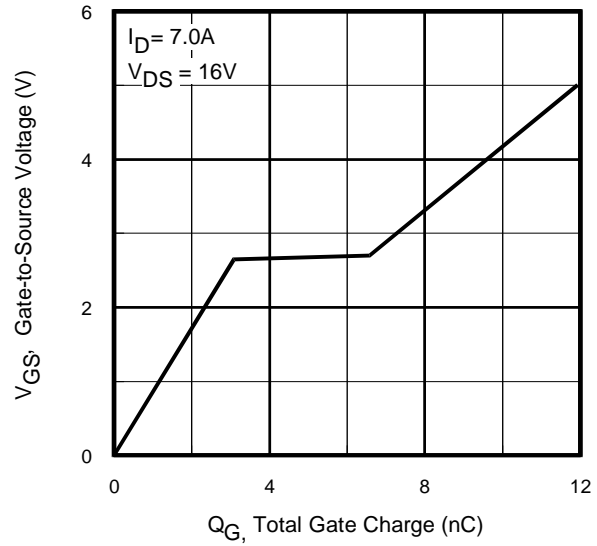


**Fig 4.** Typical Reverse Output Characteristics

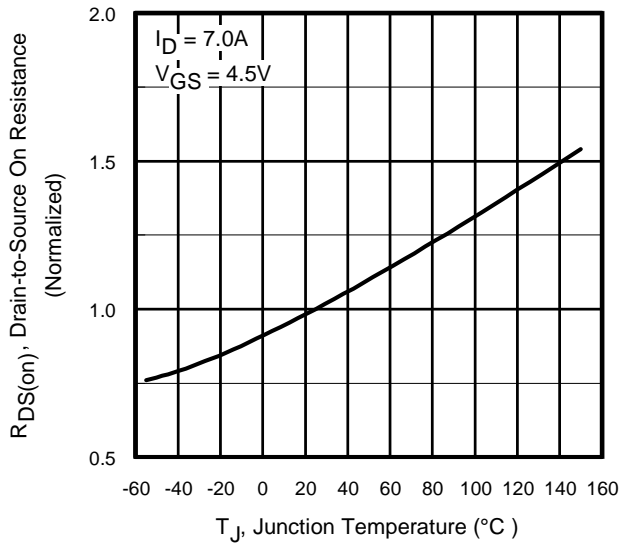
# IRF7807D2PbF



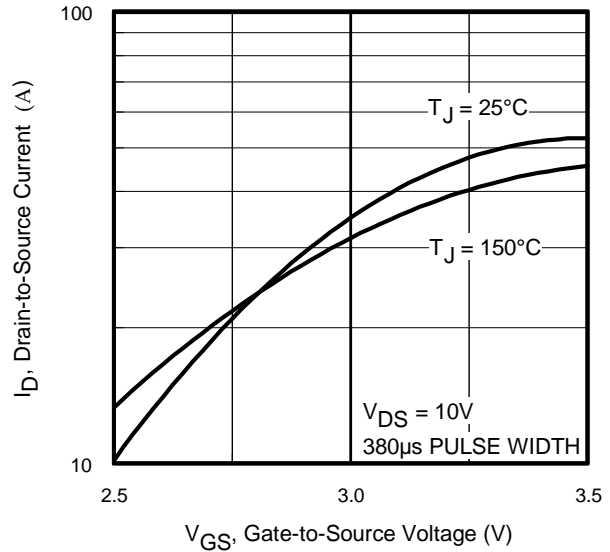
**Fig 5.** Typical Capacitance Vs. Drain-to-Source Voltage



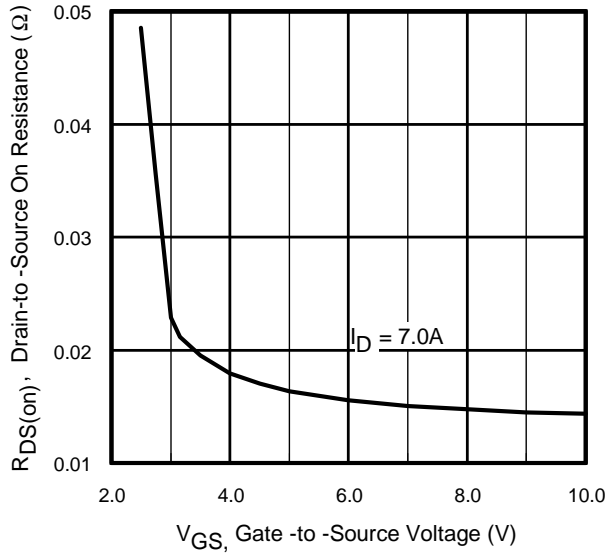
**Fig 6.** Typical Gate Charge Vs. Gate-to-Source Voltage



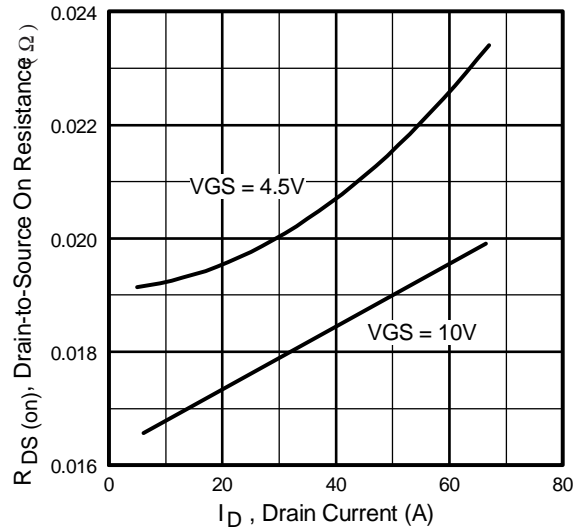
**Fig 7.** Normalized On-Resistance Vs. Temperature



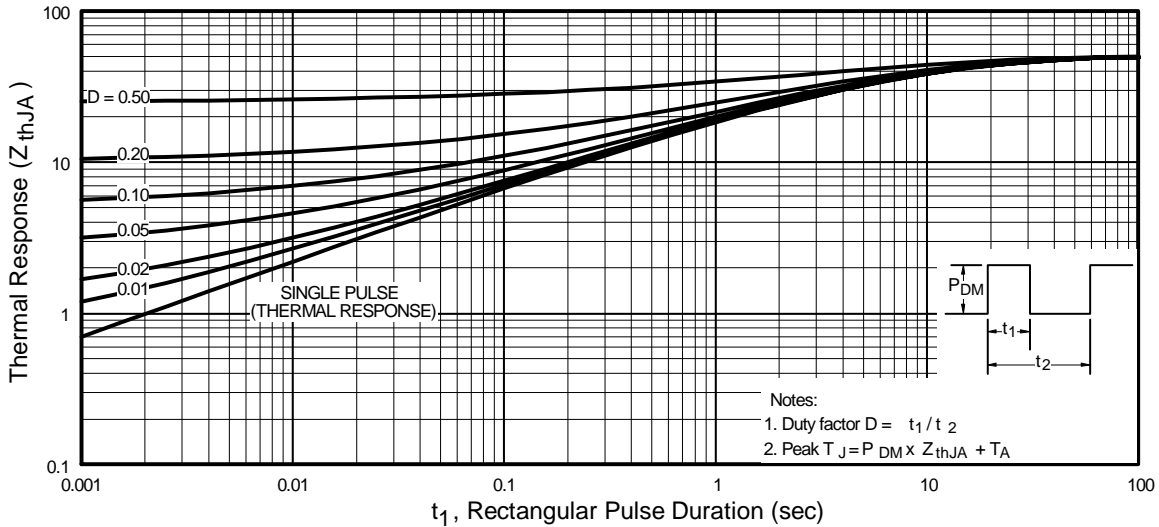
**Fig 8.** Typical Transfer Characteristics



**Fig 9.** On-Resistance Vs. Gate Voltage

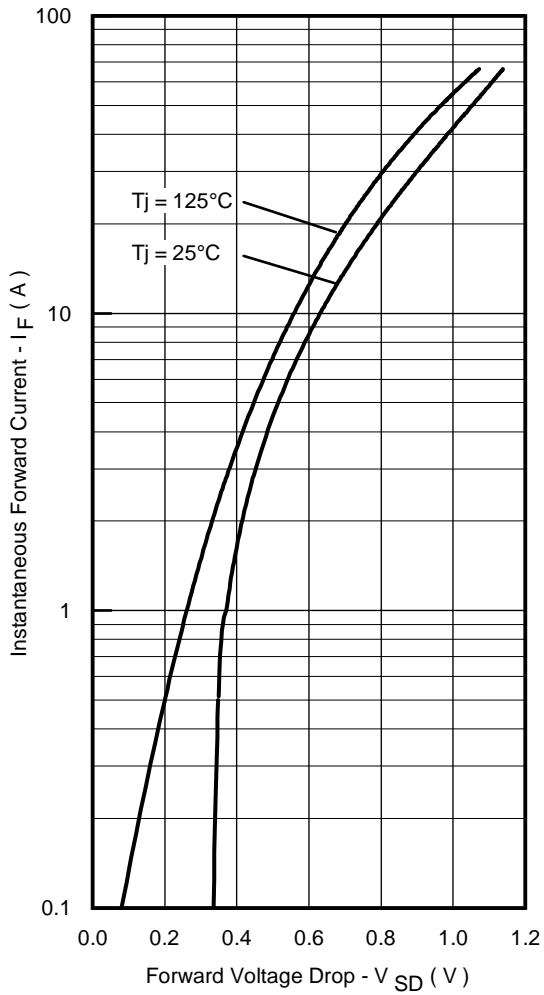


**Fig 10.** On-Resistance Vs. Drain Current

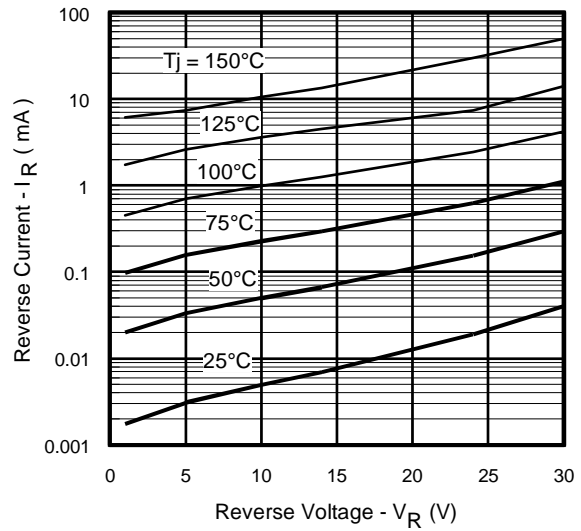


**Fig 11.** Maximum Effective Transient Thermal Impedance, Junction-to-Ambient (MOSFET)

## Mosfet, Body Diode & Schottky Diode Characteristics



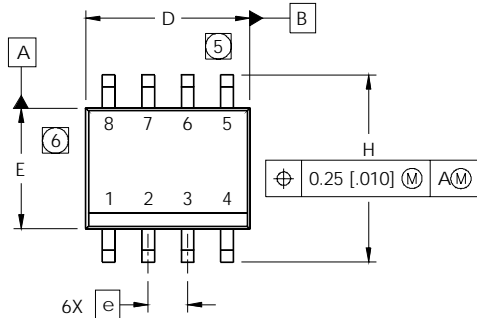
**Fig. 12** - Typical Forward Voltage Drop Characteristics



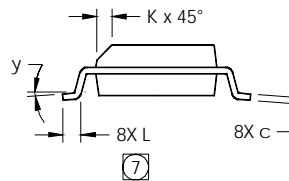
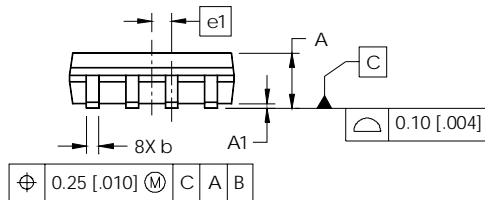
**Fig. 13** - Typical Values of Reverse Current Vs. Reverse Voltage

## SO-8 (Fetky) Package Outline

Dimensions are shown in millimeters (inches)



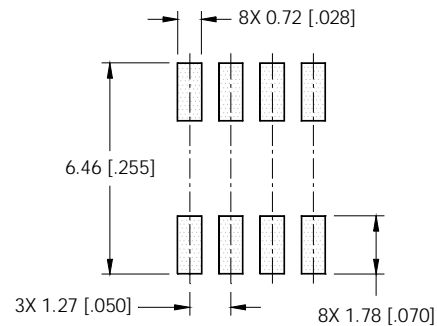
DIM	INCHES		MILLIMETERS	
	MIN	MAX	MIN	MAX
A	.0532	.0688	1.35	1.75
A1	.0040	.0098	0.10	0.25
b	.013	.020	0.33	0.51
c	.0075	.0098	0.19	0.25
D	.189	.1968	4.80	5.00
E	.1497	.1574	3.80	4.00
e	.050 BASIC		1.27 BASIC	
e1	.025 BASIC		0.635 BASIC	
H	.2284	.2440	5.80	6.20
K	.0099	.0196	0.25	0.50
L	.016	.050	0.40	1.27
y	0°	8°	0°	8°



**NOTES:**

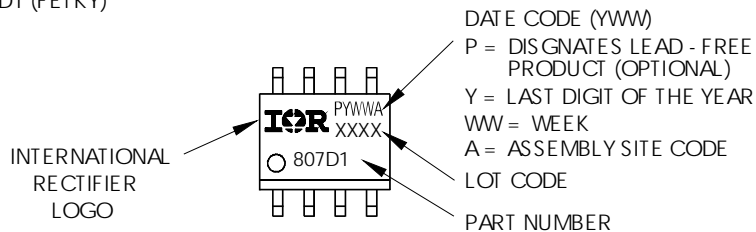
1. DIMENSIONING & TOLERANCING PER ASME Y14.5M-1994.
2. CONTROLLING DIMENSION: MILLIMETER
3. DIMENSIONS ARE SHOWN IN MILLIMETERS [INCHES].
4. OUTLINE CONFORMS TO JEDEC OUTLINE MS-012AA.
- ⑤ DIMENSION DOES NOT INCLUDE MOLD PROTRUSIONS. MOLD PROTRUSIONS NOT TO EXCEED 0.15 [0.006].
- ⑥ DIMENSION DOES NOT INCLUDE MOLD PROTRUSIONS. MOLD PROTRUSIONS NOT TO EXCEED 0.25 [0.010].
- ⑦ DIMENSION IS THE LENGTH OF LEAD FOR SOLDERING TO A SUBSTRATE.

**FOOTPRINT**



## SO-8 (Fetky) Part Marking Information

EXAMPLE: THIS IS AN IRF7807D1 (FETKY)

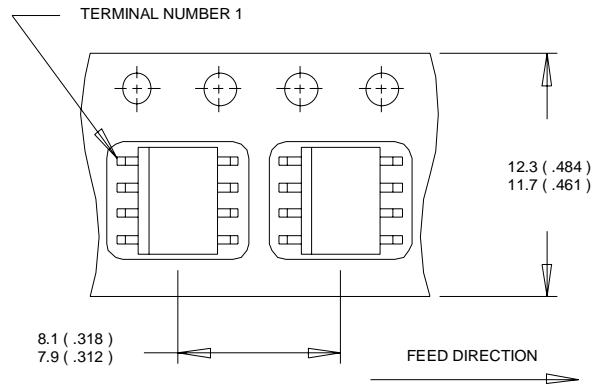


# IRF7807D2PbF

International  
**IR** Rectifier

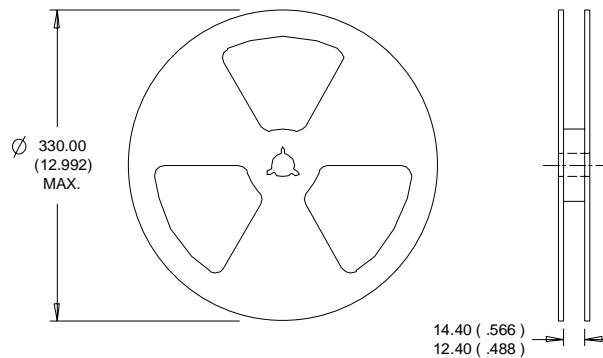
## SO-8 (Fetky) Tape and Reel

Dimensions are shown in millimeters (inches)



### NOTES:

1. CONTROLLING DIMENSION : MILLIMETER.
2. ALL DIMENSIONS ARE SHOWN IN MILLIMETERS(INCHES).
3. OUTLINE CONFORMS TO EIA-481 & EIA-541.



### NOTES :

1. CONTROLLING DIMENSION : MILLIMETER.
2. OUTLINE CONFORMS TO EIA-481 & EIA-541.

Data and specifications subject to change without notice.  
This product has been designed and qualified for the Consumer market.  
Qualifications Standards can be found on IR's Web site.

International  
**IR** Rectifier

IR WORLD HEADQUARTERS: 233 Kansas St., El Segundo, California 90245, USA Tel: (310) 252-7105  
TAC Fax: (310) 252-7903

Visit us at [www.irf.com](http://www.irf.com) for sales contact information.10/04