

# IRF8707PbF

HEXFET® Power MOSFET

## Applications

- Control MOSFET of Sync-Buck Converters used for Notebook Processor Power
- Control MOSFET for Isolated DC-DC Converters in Networking Systems

<b>V<sub>DSS</sub></b>	<b>R<sub>DS(on)</sub> max</b>	<b>Q<sub>g</sub></b>
<b>30V</b>	<b>11.9mΩ@V<sub>GS</sub> = 10V</b>	<b>6.2nC</b>

## Benefits

- Very Low Gate Charge
- Very Low R<sub>DS(on)</sub> at 4.5V V<sub>GS</sub>
- Ultra-Low Gate Impedance
- Fully Characterized Avalanche Voltage and Current
- 20V V<sub>GS</sub> Max. Gate Rating
- 100% tested for R<sub>g</sub>
- Lead-Free



## Description

The IRF8707PbF incorporates the latest HEXFET Power MOSFET Silicon Technology into the industry standard SO-8 package. The IRF8707PbF has been optimized for parameters that are critical in synchronous buck operation including R<sub>ds(on)</sub> and gate charge to reduce both conduction and switching losses. The reduced total losses make this product ideal for high efficiency DC-DC converters that power the latest generation of processors for notebook and Netcom applications.

## Absolute Maximum Ratings

	Parameter	Max.	Units
V <sub>DS</sub>	Drain-to-Source Voltage	30	V
V <sub>GS</sub>	Gate-to-Source Voltage	± 20	
I <sub>D</sub> @ T <sub>A</sub> = 25°C	Continuous Drain Current, V <sub>GS</sub> @ 10V	11	A
I <sub>D</sub> @ T <sub>A</sub> = 70°C	Continuous Drain Current, V <sub>GS</sub> @ 10V	9.1	
I <sub>DM</sub>	Pulsed Drain Current ①	88	
P <sub>D</sub> @ T <sub>A</sub> = 25°C	Power Dissipation	2.5	W
P <sub>D</sub> @ T <sub>A</sub> = 70°C	Power Dissipation	1.6	
	Linear Derating Factor	0.02	W/°C
T <sub>J</sub>	Operating Junction and	-55 to + 150	°C
T <sub>STG</sub>	Storage Temperature Range		

## Thermal Resistance

	Parameter	Typ.	Max.	Units
R <sub>θJL</sub>	Junction-to-Drain Lead ⑤	—	20	°C/W
R <sub>θJA</sub>	Junction-to-Ambient ⑥⑦	—	50	

Notes ① through ⑦ are on page 9

www.irf.com

# IRF8707PbF

International  
IR Rectifier

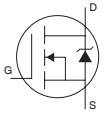
Static @  $T_J = 25^\circ\text{C}$  (unless otherwise specified)

	Parameter	Min.	Typ.	Max.	Units	Conditions
$BV_{DSS}$	Drain-to-Source Breakdown Voltage	30	—	—	V	$V_{GS} = 0V, I_D = 250\mu A$
$\Delta BV_{DSS}/\Delta T_J$	Breakdown Voltage Temp. Coefficient	—	0.022	—	V/°C	Reference to $25^\circ\text{C}, I_D = 1mA$
$R_{DS(on)}$	Static Drain-to-Source On-Resistance	—	9.3	11.9	mΩ	$V_{GS} = 10V, I_D = 11A$ ③
		—	14.2	17.5		$V_{GS} = 4.5V, I_D = 8.8A$ ③
$V_{GS(th)}$	Gate Threshold Voltage	1.35	1.80	2.35	V	$V_{DS} = V_{GS}, I_D = 25\mu A$
$\Delta V_{GS(th)}$	Gate Threshold Voltage Coefficient	—	-5.8	—	mV/°C	$V_{DS} = V_{GS}, I_D = 25\mu A$
$I_{DSS}$	Drain-to-Source Leakage Current	—	—	1.0	μA	$V_{DS} = 24V, V_{GS} = 0V$
		—	—	150		$V_{DS} = 24V, V_{GS} = 0V, T_J = 125^\circ\text{C}$
$I_{GSS}$	Gate-to-Source Forward Leakage	—	—	100	nA	$V_{GS} = 20V$
	Gate-to-Source Reverse Leakage	—	—	-100		$V_{GS} = -20V$
$g_{fs}$	Forward Transconductance	25	—	—	S	$V_{DS} = 15V, I_D = 8.8A$
$Q_g$	Total Gate Charge	—	6.2	9.3	nC	$V_{DS} = 15V$ $V_{GS} = 4.5V$ $I_D = 8.8A$ See Figs. 15 & 16
$Q_{gs1}$	Pre-Vth Gate-to-Source Charge	—	1.4	—		
$Q_{gs2}$	Post-Vth Gate-to-Source Charge	—	0.7	—		
$Q_{gd}$	Gate-to-Drain Charge	—	2.2	—		
$Q_{godr}$	Gate Charge Overdrive	—	1.9	—		
$Q_{sw}$	Switch Charge ( $Q_{gs2} + Q_{gd}$ )	—	2.9	—		
$Q_{oss}$	Output Charge	—	3.7	—	nC	$V_{DS} = 16V, V_{GS} = 0V$
$R_g$	Gate Resistance	—	2.2	3.7	Ω	
$t_{d(on)}$	Turn-On Delay Time	—	6.7	—	ns	$V_{DD} = 15V, V_{GS} = 4.5V$ $I_D = 8.8A$ $R_G = 1.8\Omega$ See Fig. 18
$t_r$	Rise Time	—	7.9	—		
$t_{d(off)}$	Turn-Off Delay Time	—	7.3	—		
$t_f$	Fall Time	—	4.4	—		
$C_{iss}$	Input Capacitance	—	760	—	pF	$V_{GS} = 0V$ $V_{DS} = 15V$ $f = 1.0MHz$
$C_{oss}$	Output Capacitance	—	170	—		
$C_{rss}$	Reverse Transfer Capacitance	—	82	—		

## Avalanche Characteristics

	Parameter	Typ.	Max.	Units
$E_{AS}$	Single Pulse Avalanche Energy ②	—	53	mJ
$I_{AR}$	Avalanche Current ①	—	8.8	A

## Diode Characteristics

	Parameter	Min.	Typ.	Max.	Units	Conditions
$I_S$	Continuous Source Current (Body Diode)	—	—	3.1	A	MOSFET symbol showing the integral reverse p-n junction diode. 
$I_{SM}$	Pulsed Source Current (Body Diode) ①	—	—	88	A	
$V_{SD}$	Diode Forward Voltage	—	—	1.0	V	$T_J = 25^\circ\text{C}, I_S = 8.8A, V_{GS} = 0V$ ③
$t_{rr}$	Reverse Recovery Time	—	12	18	ns	$T_J = 25^\circ\text{C}, I_F = 8.8A, V_{DD} = 15V$
$Q_{rr}$	Reverse Recovery Charge	—	13	20	nC	$di/dt = 300A/\mu s$ ③
$t_{on}$	Forward Turn-On Time	Intrinsic turn-on time is negligible (turn-on is dominated by LS+LD)				

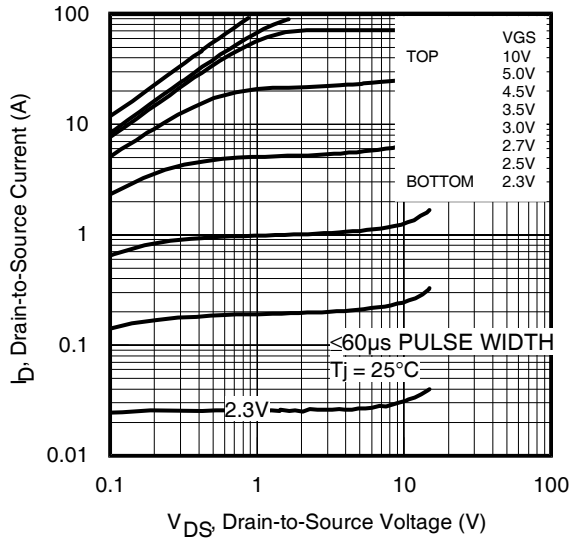


Fig 1. Typical Output Characteristics

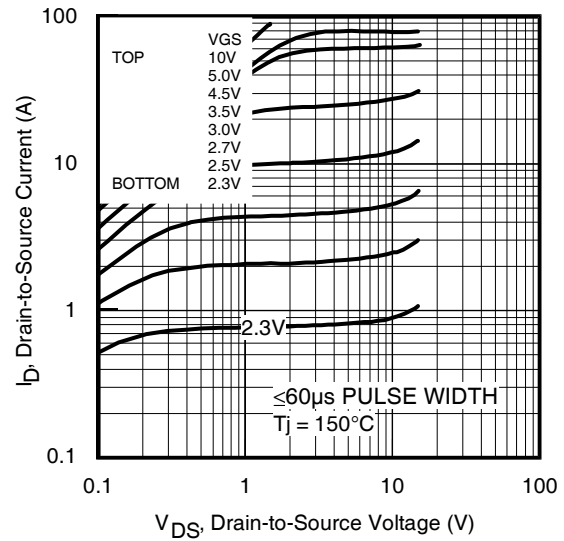


Fig 2. Typical Output Characteristics

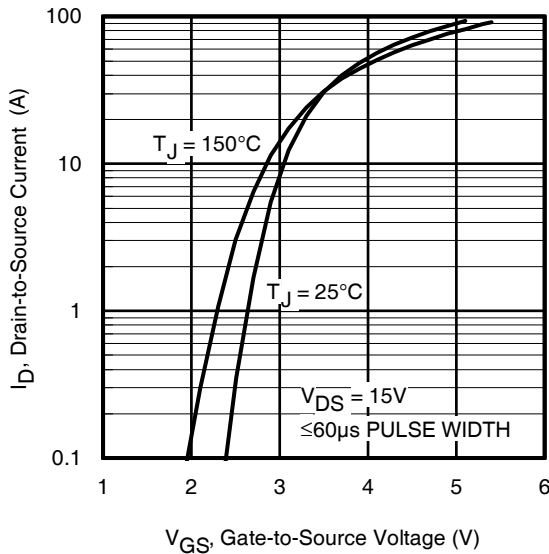


Fig 3. Typical Transfer Characteristics

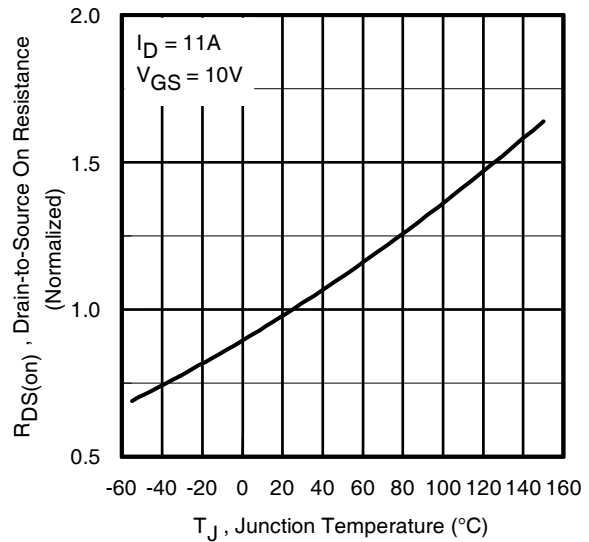
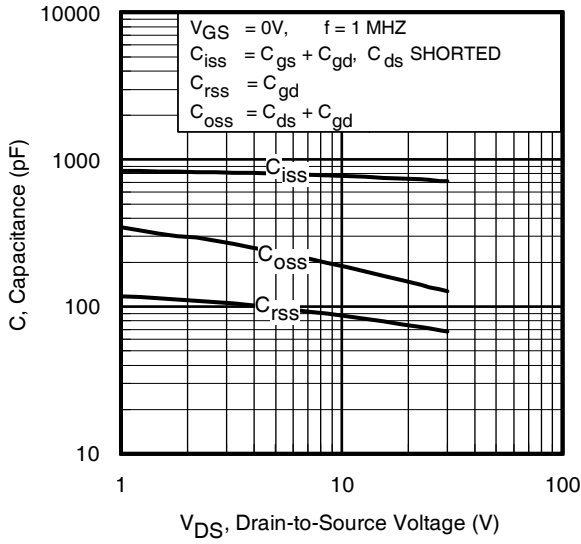


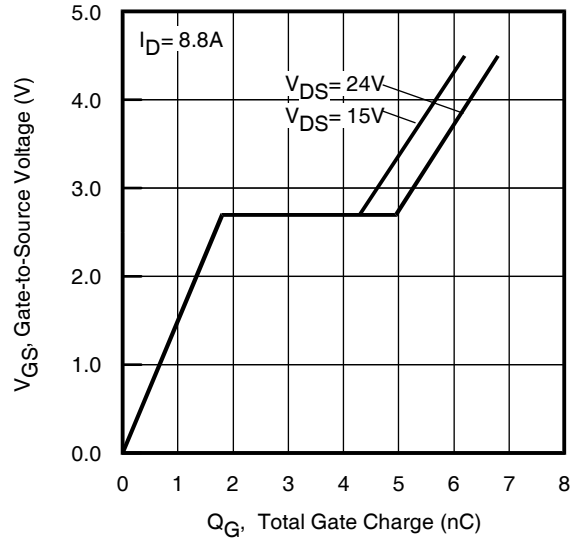
Fig 4. Normalized On-Resistance vs. Temperature

# IRF8707PbF

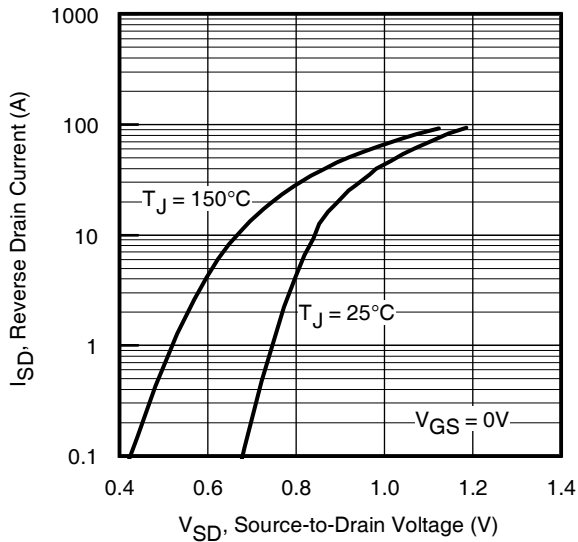
International  
**IR** Rectifier



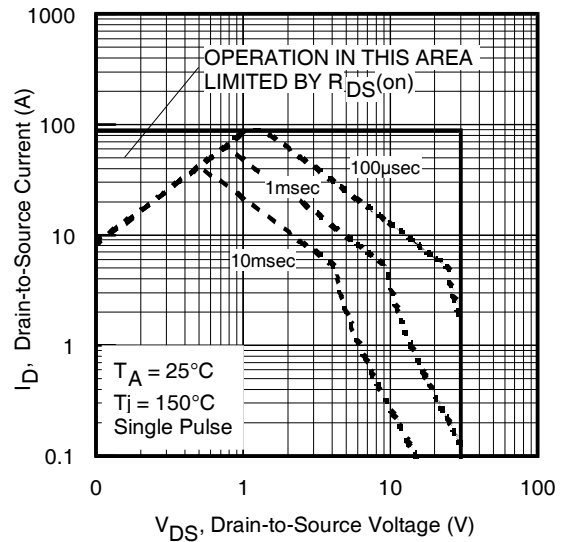
**Fig 5.** Typical Capacitance vs. Drain-to-Source Voltage



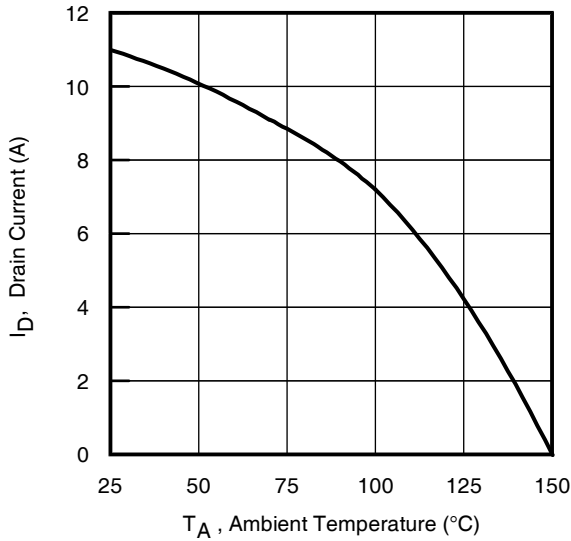
**Fig 6.** Typical Gate Charge Vs. Gate-to-Source Voltage



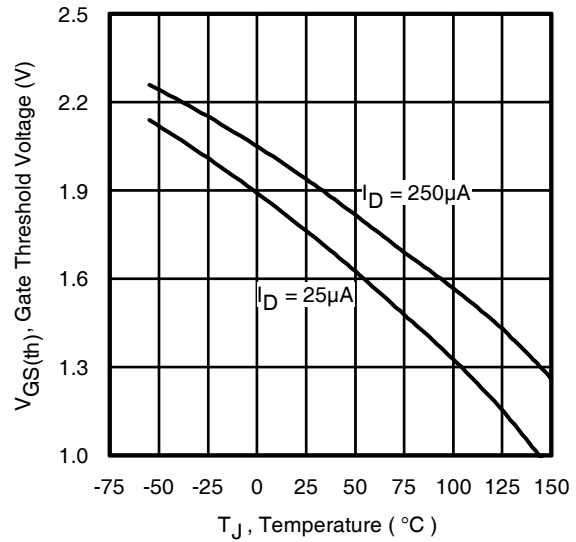
**Fig 7.** Typical Source-Drain Diode Forward Voltage



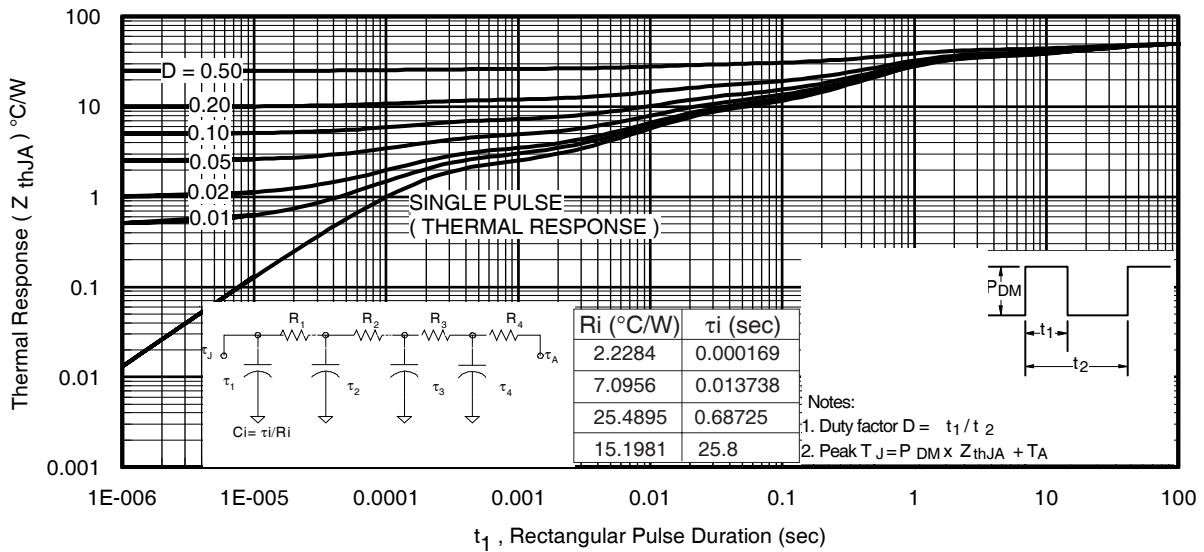
**Fig 8.** Maximum Safe Operating Area



**Fig 9.** Maximum Drain Current vs. Ambient Temperature



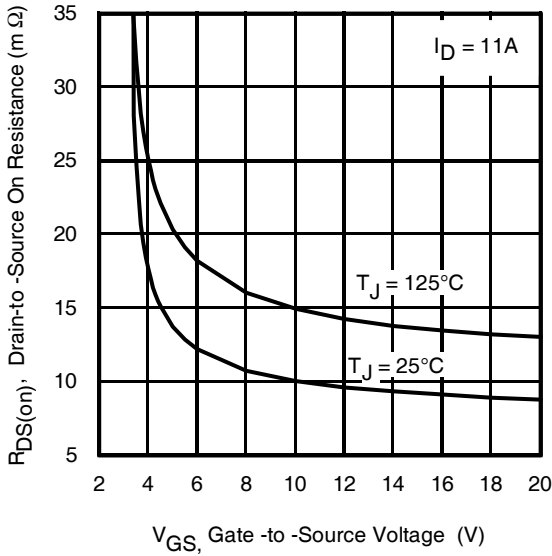
**Fig 10.** Threshold Voltage vs. Temperature



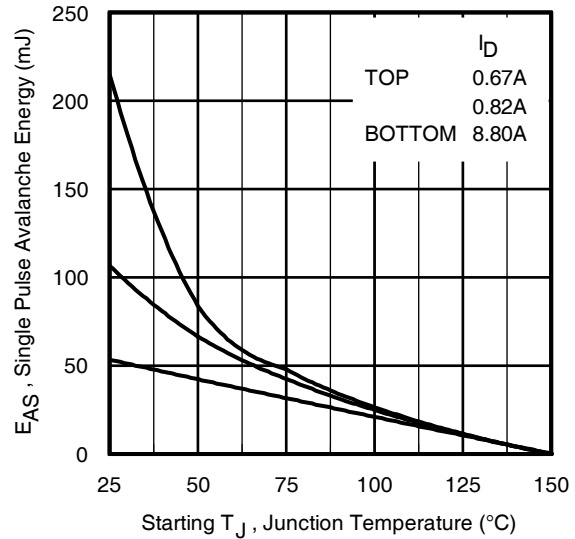
**Fig 11.** Maximum Effective Transient Thermal Impedance, Junction-to-Ambient

# IRF8707PbF

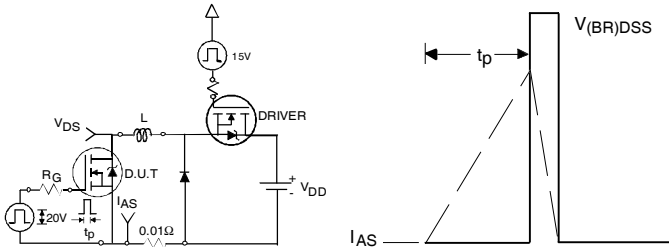
International  
**IR** Rectifier



**Fig 12.** On-Resistance vs. Gate Voltage



**Fig 13.** Maximum Avalanche Energy vs. Drain Current



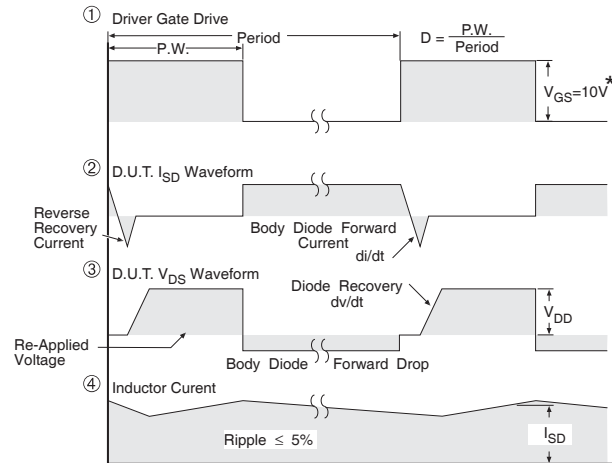
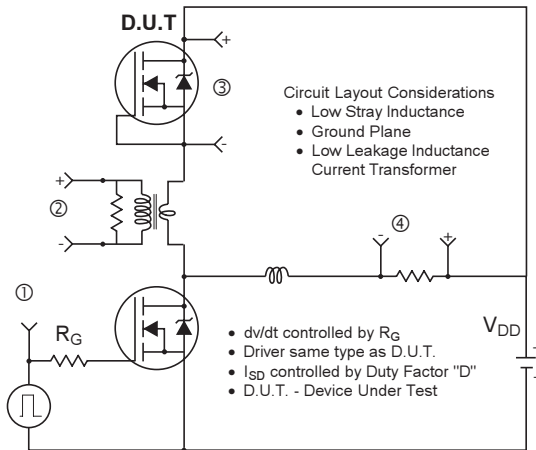
**Fig 14.** Unclamped Inductive Test Circuit and Waveform



**Fig 15.** Gate Charge Test Circuit

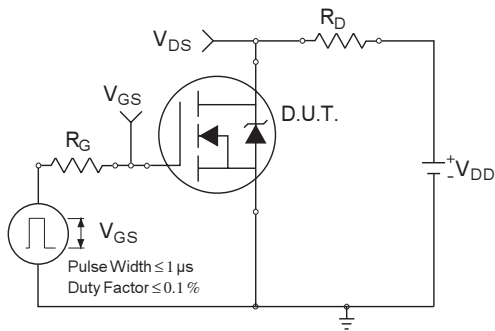


**Fig 16.** Gate Charge Waveform



\*  $V_{GS} = 5V$  for Logic Level Devices

**Fig 17. Peak Diode Recovery  $dv/dt$  Test Circuit for N-Channel HEXFET® Power MOSFETs**



**Fig 18a. Switching Time Test Circuit**



**Fig 18b. Switching Time Waveforms**

# IRF8707PbF

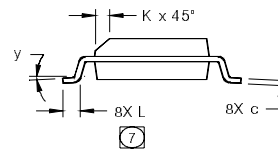
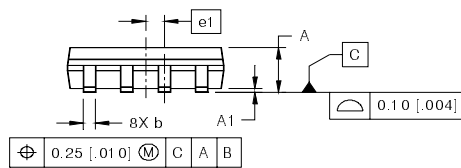
## SO-8 Package Outline

International  
**IR** Rectifier

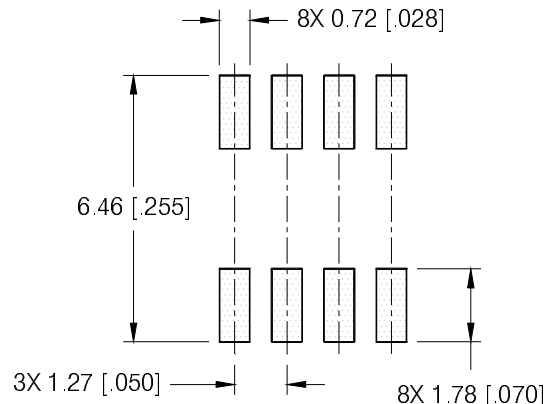
Dimensions are shown in millimeters (inches)



DIM	INCHES		MILLIMETERS	
	MIN	MAX	MIN	MAX
A	.0532	.0688	1.35	1.75
A1	.0040	.0098	0.10	0.25
b	.013	.020	0.33	0.51
c	.0075	.0098	0.19	0.25
D	.189	.1968	4.80	5.00
E	.1497	.1574	3.80	4.00
e	.050 BASIC		1.27 BASIC	
e 1	.025 BASIC		0.635 BASIC	
H	.2284	.2440	5.80	6.20
K	.0099	.0196	0.25	0.50
L	.016	.050	0.40	1.27
y	0°	8°	0°	8°



### FOOTPRINT

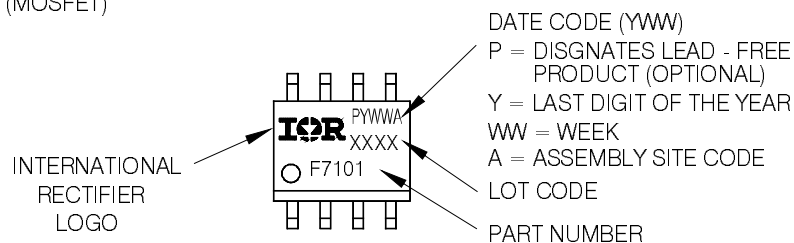


#### NOTES:

- DIMENSIONING & TOLERANCING PER ASME Y14.5M-1994.
- CONTROLLING DIMENSION: MILLIMETER
- DIMENSIONS ARE SHOWN IN MILLIMETERS [INCHES].
- OUTLINE CONFORMS TO JEDEC OUTLINE MS-012AA.
- 5** DIMENSION DOES NOT INCLUDE MOLD PROTRUSIONS. MOLD PROTRUSIONS NOT TO EXCEED 0.15 [0.006].
- 6** DIMENSION DOES NOT INCLUDE MOLD PROTRUSIONS. MOLD PROTRUSIONS NOT TO EXCEED 0.25 [0.010].
- 7** DIMENSION IS THE LENGTH OF LEAD FOR SOLDERING TO A SUBSTRATE.

## SO-8 Part Marking Information

EXAMPLE: THIS IS AN IRF7101 (MOSFET)

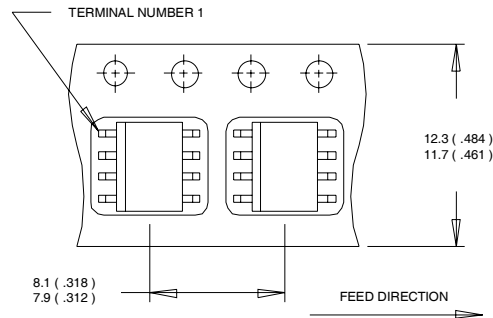


Note: For the most current drawing please refer to IR website at <http://www.irf.com/package>



## SO-8 Tape and Reel

Dimensions are shown in millimeters (inches)



- NOTES:
1. CONTROLLING DIMENSION : MILLIMETER.
  2. ALL DIMENSIONS ARE SHOWN IN MILLIMETERS(INCHES).
  3. OUTLINE CONFORMS TO EIA-481 & EIA-541.



- NOTES:
1. CONTROLLING DIMENSION : MILLIMETER.
  2. OUTLINE CONFORMS TO EIA-481 & EIA-541.

**Notes:**

- ① Repetitive rating; pulse width limited by max. junction temperature.
- ② Starting  $T_J = 25^\circ\text{C}$ ,  $L = 1.38\text{mH}$ ,  $R_G = 25\Omega$ ,  $I_{AS} = 8.8\text{A}$ .
- ③ Pulse width  $\leq 400\mu\text{s}$ ; duty cycle  $\leq 2\%$ .
- ④ When mounted on 1 inch square copper board.
- ⑤  $R_\theta$  is measured at  $T_J$  of approximately  $90^\circ\text{C}$ .

**Note: For the most current drawing please refer to IR website at <http://www.irf.com/package>**

Data and specifications subject to change without notice.

This product has been designed and qualified for the Consumer market.

Qualification Standards can be found on IR's Web site.