

INTERNATIONAL RECTIFIER

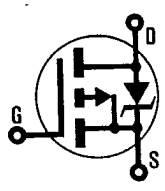

REPETITIVE AVALANCHE AND dv/dt RATED

HEXFET® TRANSISTORS



P-CHANNEL

- IRFR9010
- IRFR9012
- IRFU9010
- IRFU9012

- 50 Volt, 0.50 Ohm HEXFET

The HEXFET® technology is the key to International Rectifier's advanced line of power MOSFET transistors. The efficient geometry and unique processing of this latest "State of the Art" design achieves: very low on-state resistance combined with high transconductance; superior reverse energy and diode recovery dv/dt capability.

The HEXFET transistors also feature all of the well established advantages of MOSFETs such as voltage control, very fast switching, ease of paralleling and temperature stability of the electrical parameters.

Surface mount packages enhance circuit performance by reducing stray inductances and capacitance. The D-Pak (TO-252AA) surface mount package brings the advantages of HEXFETs to high volume applications where PC Board surface mounting is desirable. The surface mount option IRFR9010 is provided on 16mm tape. The straight lead option IRFU9010 of the device is called the I-Pak (TO-251AA).

They are well suited for applications where limited heat dissipation is required such as, computers and peripherals, telecommunications equipment, DC/DC converters, and a wide range of consumer products.

Product Summary

Part Number	BVDSS	R _{DS(on)}	I _D
IRFR9010	-50V	0.50Ω	-5.3A
IRFR9012	-50V	0.70Ω	-4.5A
IRFU9010	-50V	0.50Ω	-5.3A
IRFU9012	-50V	0.70Ω	-4.5A

FEATURES:

- Surface Mountable (Order As IRFR9010)
- Straight Lead Option (Order As IRFU9010)
- Repetitive Avalanche Ratings
- Dynamic dv/dt Rating
- Simple Drive Requirements
- Ease of Paralleling

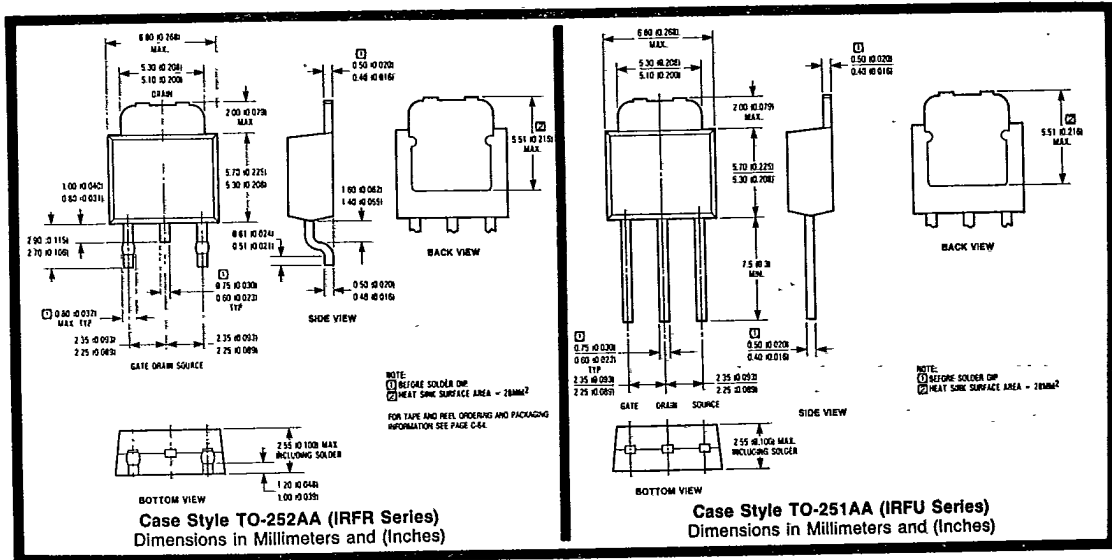

IRFR9010, IRFR9012, IRFU9010, IRFU9012 Devices

INTERNATIONAL RECTIFIER

Absolute Maximum Ratings

Parameter	IRFR9010, IRFU9010	IRFR9012, IRFU9012	Units
$I_D @ T_C = 25^\circ\text{C}$ Continuous Drain Current	-5.3	-4.5	A
$I_D @ T_C = 100^\circ\text{C}$ Continuous Drain Current	-3.3	-2.8	A
I_{DM} Pulsed Drain Current ①	-21	-18	A
$P_D @ T_C = 25^\circ\text{C}$ Max. Power Dissipation	25		W
Linear Derating Factor	0.20		W/K ⑤
V_{GS} Gate-to-Source Voltage	± 20		V
E_{AS} Single Pulse Avalanche Energy ②	240 (See Fig. 14)		mJ
I_{AR} Avalanche Current ① (Repetitive or Non-Repetitive)	-5.3 (See E_{AR})		A
E_{AR} Repetitive Avalanche Energy ①	2.5 (See I_{AR})		mJ
dv/dt Peak Diode recovery dv/dt ③	5.8 (See Fig. 17)		V/ns
T_J Operating Junction Temperature	-55 to 150		$^\circ\text{C}$
T_{STG} Storage Temperature Range			$^\circ\text{C}$
Lead Temperature	300 (0.063 in. (1.6mm) from case for 10s)		$^\circ\text{C}$

Electrical Characteristics @ $T_J = 25^\circ\text{C}$ (Unless Otherwise Specified)

Parameter	Type	Min.	Typ.	Max.	Units	Test Conditions
BV_{DSS} Drain-to-Source Breakdown Voltage	ALL	-50			V	$V_{GS} = 0V, I_D = -250\mu\text{A}$
$R_{DS(on)}$ Static Drain-to-Source On-State Resistance ④	IRFR9010 IRFU9010 IRFR9012 IRFU9012	—	0.35 0.50	0.50 0.70	Ω	$V_{GS} = -10V, I_D = -2.8A$
$I_{D(on)}$ On-State Drain Current ④	IRFR9010 IRFU9010 IRFR9012 IRFU9012	-5.3 -4.5	—	—	A	$V_{DS} > I_{D(on)} \times R_{DS(on)}$ Max. $V_{GS} = -10V$
$V_{GS(th)}$ Gate Threshold Voltage	ALL	-2.0	—	-4.0	V	$V_{DS} = V_{GS}, I_D = -250\mu\text{A}$
g_{fs} Forward Transconductance ④	ALL	1.1	1.7	—	S(V)	$V_{DS} \leq -50V, I_{DS} = -2.8A$
I_{DSS} Zero Gate Voltage Drain Current	ALL	—	—	-250 -1000	μA	$V_{DS} = \text{Max. Rating}, V_{GS} = 0V$ $V_{DS} = 0.8 \times \text{Max. Rating}$ $V_{GS} = 0V, T_J = 125^\circ\text{C}$
I_{GSS} Gate-to-Source Leakage Forward	ALL	—	—	-500	nA	$V_{GS} = -20V$
I_{GSS} Gate-to-Source Leakage Reverse	ALL	—	—	500	nA	$V_{GS} = 20V$
Q_g Total Gate Charge	ALL	—	6.1	9.1	nC	$V_{GS} = -10V, I_D = -4.7A$
Q_{gs} Gate-to-Source Charge	ALL	—	2.0	3.0	nC	$V_{DS} = 0.8 \times \text{Max. Rating}$ See Fig. 16
Q_{gd} Gate-to-Drain ("Miller") Charge	—	—	3.9	5.9	nC	(Independent of operating temperature)
$t_{d(on)}$ Turn-On Delay Time	ALL	—	6.1	9.2	ns	$V_{DD} = -25V, I_D = -4.7A, R_G = 24\Omega$
t_r Rise Time	ALL	—	47	71	ns	$R_D = 5.6\Omega$
$t_{d(off)}$ Turn-Off Delay Time	ALL	—	13	20	ns	See Fig. 15
t_f Fall Time	ALL	—	35	59	ns	(Independent of operating temperature)
L_D Internal Drain Inductance	ALL	—	4.5	—	nH	Measured from the drain lead, 6mm (0.25 in.) from package to center of die.
L_S Internal Source Inductance	ALL	—	7.5	—	nH	Measured from the source lead, 6mm (0.25 in.) from package to source bonding pad.
C_{iss} Input Capacitance	ALL	—	240	—	pF	$V_{GS} = 0V, V_{DS} = -25V$
C_{oss} Output Capacitance	ALL	—	160	—	pF	$f = 1.0 \text{ MHz}$
C_{rss} Reverse Transfer Capacitance	ALL	—	30	—	pF	See Fig. 10

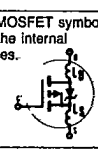

Source-Drain Diode Ratings and Characteristics

Parameter	Type	Min.	Typ.	Max.	Units	Test Conditions
I_S Continuous Source Current (Body Diode)	ALL	—	—	-5.3	A	Modified MOSFET symbol showing the integral Reverse p-n junction rectifier. 
I_{SM} Pulsed Source Current (Body Diode) ①	ALL	—	—	-18	A	
V_{SD} Diode Forward Voltage ④	ALL	—	—	-5.5	V	$T_J = 25^\circ\text{C}$, $I_S = -5.3\text{A}$, $V_{GS} = 0\text{V}$
t_{rr} Reverse Recovery Time	ALL	33	75	160	ns	$T_J = 25^\circ\text{C}$, $I_F = -4.7\text{A}$, $di/dt = 100\text{ A}/\mu\text{s}$
Q_{RR} Reverse Recovery Charge	ALL	0.090	0.22	0.52	μC	
t_{on} Forward Turn-On Time	ALL	Intrinsic turn-on time is negligible. Turn-on speed is substantially controlled by $L_S + L_D$.				

Thermal Resistance

R_{thJC} Junction-to-Case	ALL	—	—	5.0	K/W ⑤	
R_{thCS} Case-to-Sink	ALL	—	1.7	—	K/W ⑤	Typical solder mount ⑥
R_{thJA} Junction-to-Ambient	ALL	—	—	110	K/W ⑤	Typical socket mount

- ① Repetitive Rating; Pulse width limited by maximum junction temperature (see figure 5)
- ② @ $V_{DD} = -25\text{V}$, Starting $T_J = 25^\circ\text{C}$, $L = 9.7\text{ mH}$, $R_G = 25\Omega$, Peak $I_L = -5.3\text{A}$
- ③ $I_{SD} \leq -5.3\text{A}$, $di/dt \leq -80\text{ A}/\mu\text{s}$, $V_{DD} 40\text{V}$, $T_J \leq 150^\circ\text{C}$, Suggested $R_G = 24\Omega$
- ④ Pulse width $\leq 300\ \mu\text{s}$; Duty Cycle $\leq 2\%$
- ⑤ $\text{K/W} = \text{C/W}$, $\text{W/K} = \text{W}/^\circ\text{C}$
- ⑥ Mounting pad must cover heatsink surface area. See case style drawing on front page



The information shown on the following graphs applies also to the IRFU devices.

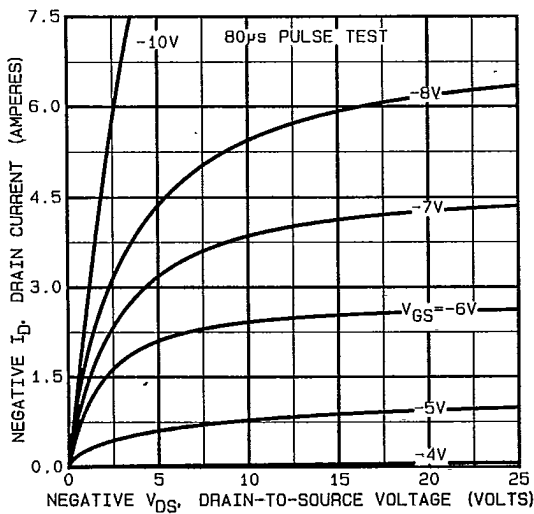

Fig. 1 — Typical Output Characteristics

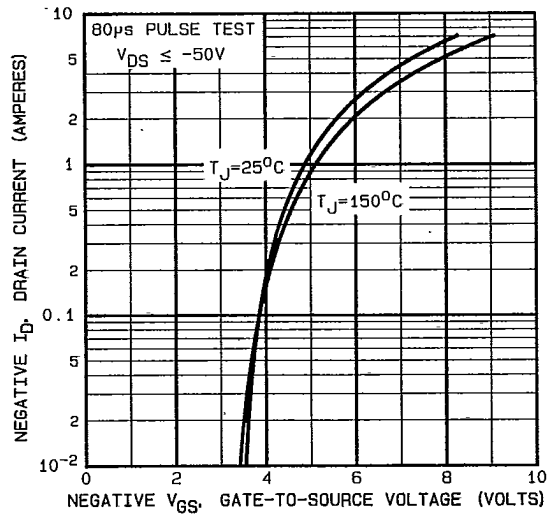

Fig. 2 — Typical Transfer Characteristics

IRFR9010, IRFR9012, IRFU9010, IRFU9012 Devices

INTERNATIONAL RECTIFIER

T-37-25

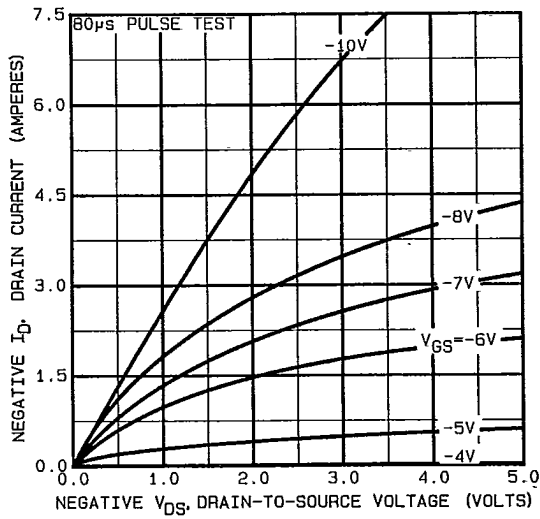

Fig. 3 — Typical Saturation Characteristics

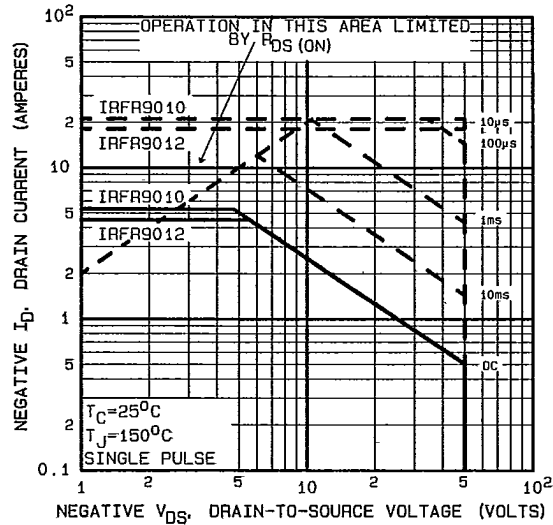

Fig. 4 — Maximum Safe Operating Area

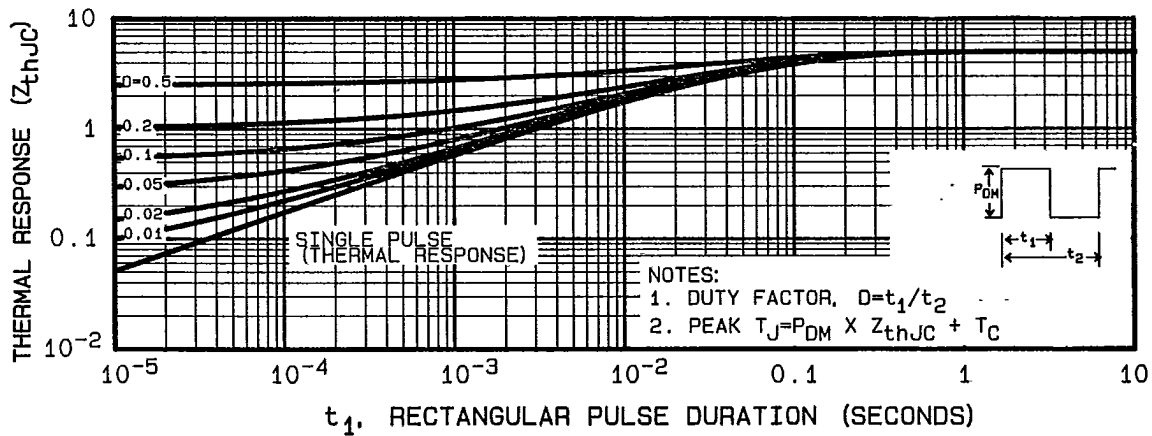

Fig. 5 — Maximum Effective Transient Thermal Impedance, Junction-to-Case Vs. Pulse Duration

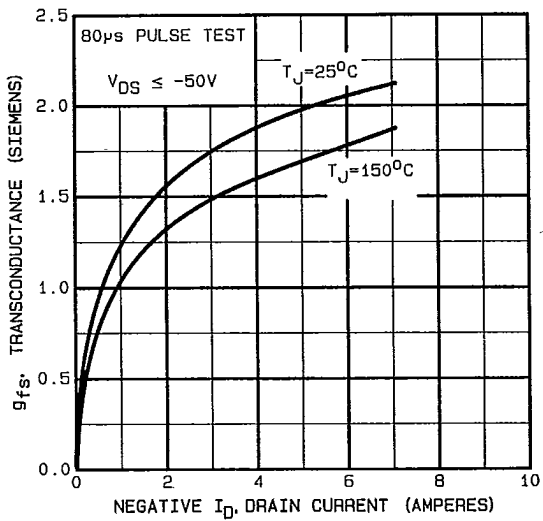

Fig. 6 — Typical Transconductance Vs. Drain Current

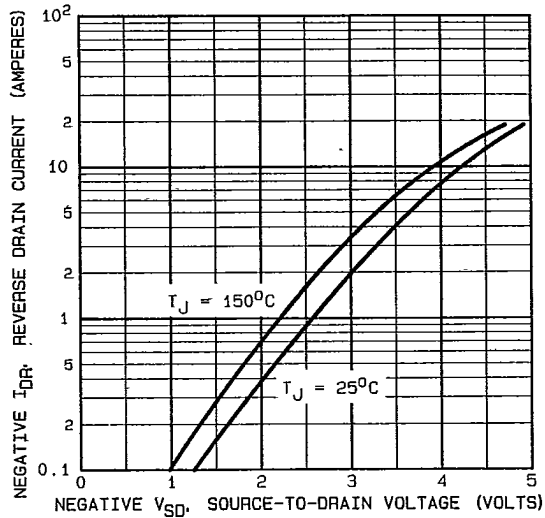

Fig. 7 — Typical Source-Drain Diode Forward Voltage

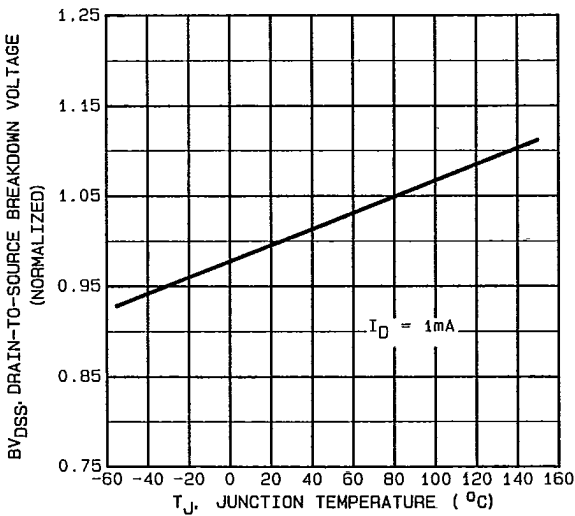

Fig. 8 — Breakdown Voltage Vs. Temperature

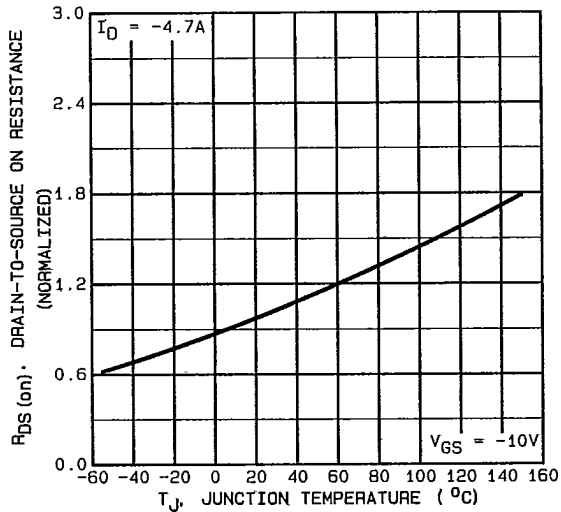

Fig. 9 — Normalized On-Resistance Vs. Temperature

IRFR9010, IRFR9012, IRFU9010, IRFU9012 Devices

T-37-25

INTERNATIONAL RECTIFIER

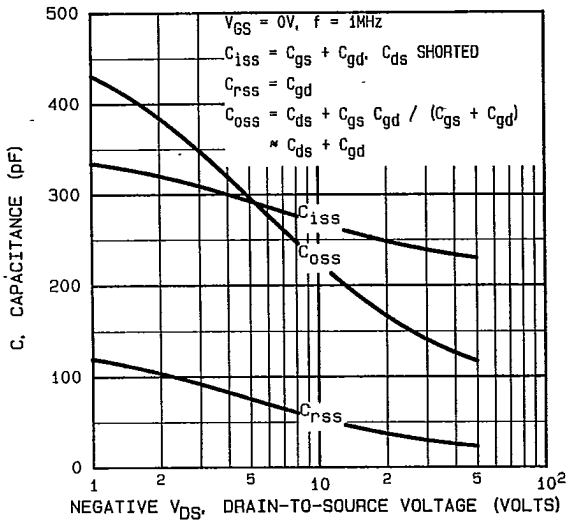

Fig. 10 — Typical Capacitance Vs. Drain-to-Source Voltage

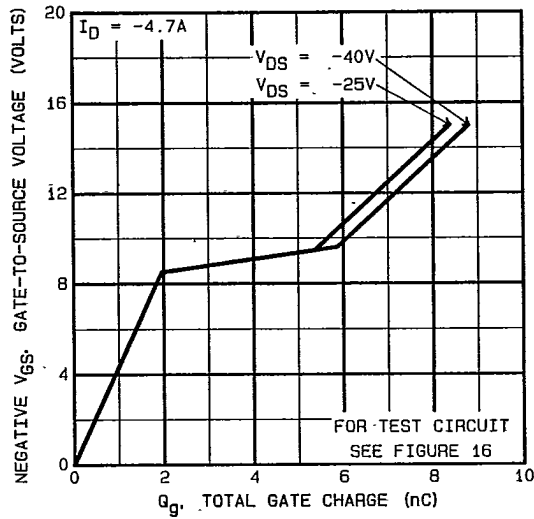

Fig. 11 — Typical Gate Charge Vs. Gate-to-Source Voltage

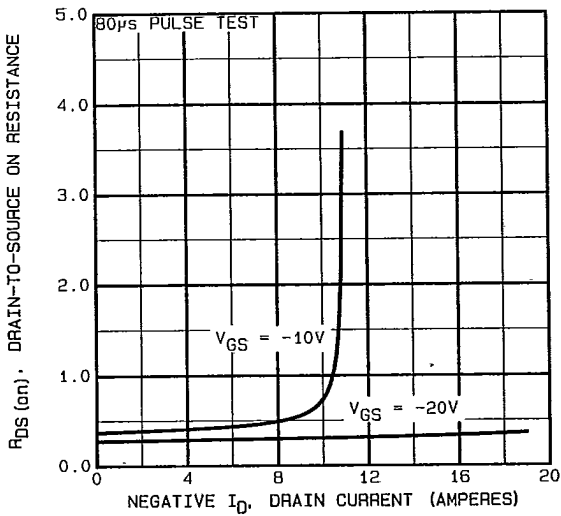

Fig. 12 — Typical On-Resistance Vs. Drain Current

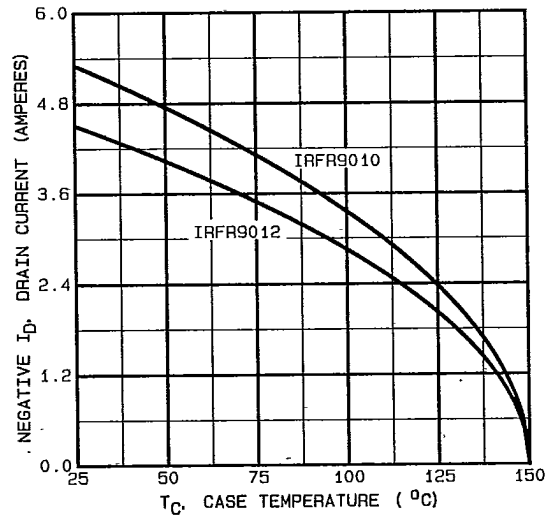

Fig. 13 — Maximum Drain Current Vs. Case Temperature

IRFR9010, IRFR9012, IRFU9010, IRFU9012 Devices

INTERNATIONAL RECTIFIER

T-37-25

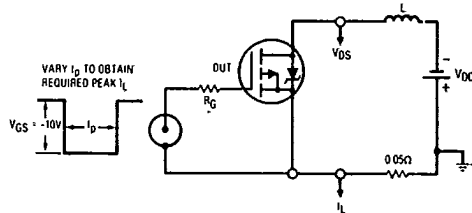

Fig. 14a — Unclamped Inductive Test Circuit

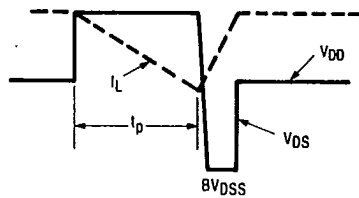

Fig. 14b — Unclamped Inductive Waveforms

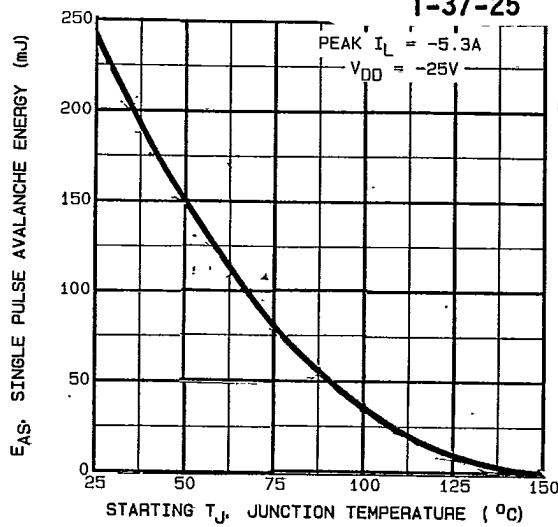

Fig. 14c — Maximum Avalanche Vs. Starting Junction Temperature

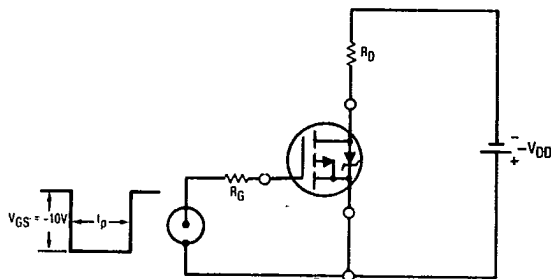
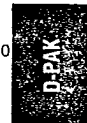

Fig. 15a — Switching Time Test Circuit

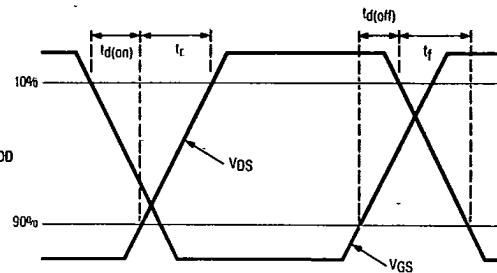

Fig. 15b — Switching Time Waveforms

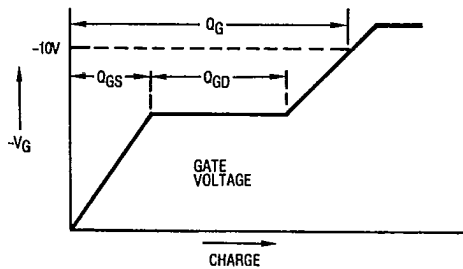

Fig. 16a — Basic Gate Charge Waveform

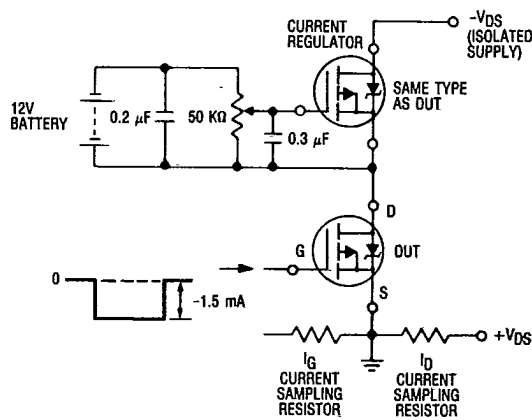

Fig. 16b — Gate Charge Test Circuit

IRFR9010, IRFR9012, IRFU9010, IRFU9012 Devices

T-37-25

INTERNATIONAL RECTIFIER

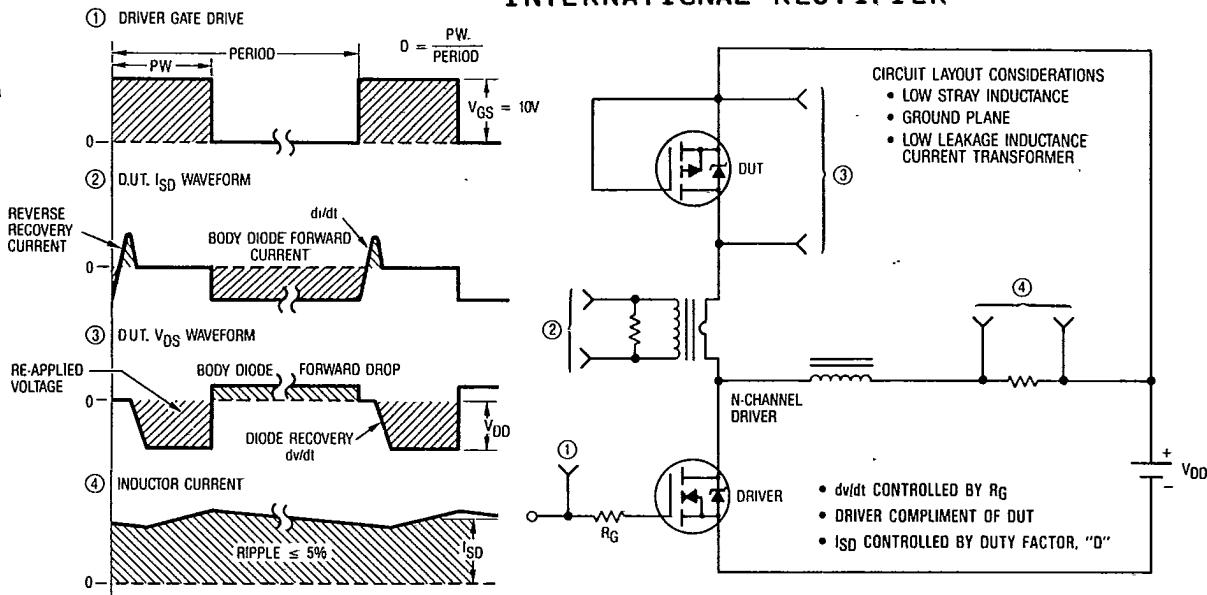

Fig. 17 — Peak Diode Recovery dv/dt Test Circuit

ORDERING INFORMATION

PACKAGING

IRFR Series — Tape and reel
 when ordering, add TR after the part number
 and the quantity
 (order in multiples of 3,000 pieces).

Example: IRFR9010TR — 15,000 pieces

