

NDP603AL / NDB603AL N-Channel Logic Level Enhancement Mode Field Effect Transistor

General Description

These N-Channel logic level enhancement mode power field effect transistors are produced using Fairchild's proprietary, high cell density, DMOS technology. This very high density process is especially tailored to minimize on-state resistance. These devices are particularly suited for low voltage applications such as DC/DC converters and high efficiency switching circuits where fast switching, low in-line power loss, and resistance to transients are needed.

Features

- 25A, 30V. $R_{DS(ON)} = 0.022\Omega @ V_{GS}=10V$.
- Critical DC electrical parameters specified at elevated temperature.
- Rugged internal source-drain diode can eliminate the need for an external Zener diode transient suppressor.
- High density cell design for extremely low $R_{DS(ON)}$.
- 175°C maximum junction temperature rating.

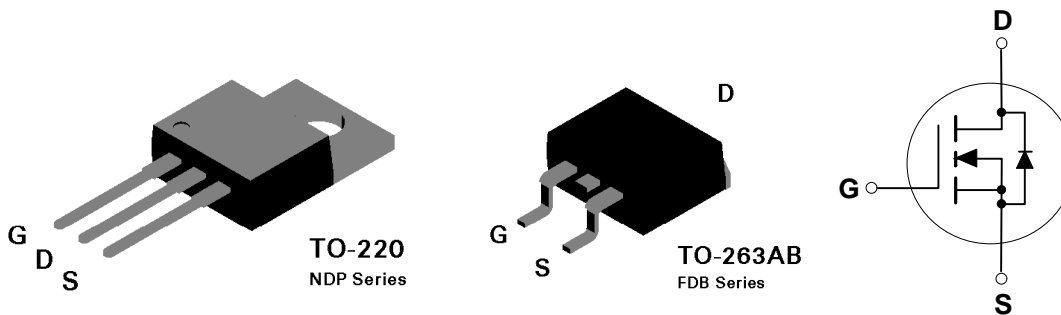

Absolute Maximum Ratings $T_c = 25^\circ\text{C}$ unless otherwise noted

Symbol	Parameter	NDP603AL	NDB603AL	Units
V_{DSS}	Drain-Source Voltage	30		V
V_{GSS}	Gate-Source Voltage - Continuous	± 20		V
I_D	Drain Current	- Continuous	25 (Note 1)	A
		- Pulsed	100	
P_D	Total Power Dissipation @ $T_c = 25^\circ\text{C}$ Derate above 25°C	50		W
		0.4		W/°C
T_J, T_{STG}	Operating and Storage Temperature Range	-65 to 175		°C
T_L	Maximum lead temperature for soldering purposes, 1/8" from case for 5 seconds	275		°C

THERMAL CHARACTERISTICS

$R_{\theta JC}$	Thermal Resistance, Junction-to-Case	2.5	°C/W
$R_{\theta JA}$	Thermal Resistance, Junction-to-Ambient	62.5	°C/W

Electrical Characteristics ($T_C = 25^\circ\text{C}$ unless otherwise noted)

Symbol	Parameter	Conditions	Min	Typ	Max	Units	
DRAIN-SOURCE AVALANCHE RATINGS (Note 2)							
W_{DSS}	Single Pulse Drain-Source Avalanche Energy	$V_{DD} = 15\text{ V}$, $I_D = 25\text{ A}$			100	mJ	
I_{AR}	Maximum Drain-Source Avalanche Current				25	A	
OFF CHARACTERISTICS							
BV_{DSS}	Drain-Source Breakdown Voltage	$V_{GS} = 0\text{ V}$, $I_D = 250\ \mu\text{A}$	30			V	
I_{DSS}	Zero Gate Voltage Drain Current	$V_{DS} = 24\text{ V}$, $V_{GS} = 0\text{ V}$			10	μA	
I_{GSSF}	Gate - Body Leakage, Forward	$V_{GS} = 20\text{ V}$, $V_{DS} = 0\text{ V}$			100	nA	
I_{GSSR}	Gate - Body Leakage, Reverse	$V_{GS} = -20\text{ V}$, $V_{DS} = 0\text{ V}$			-100	nA	
ON CHARACTERISTICS (Note 2)							
$V_{GS(th)}$	Gate Threshold Voltage	$V_{DS} = V_{GS}$, $I_D = 250\ \mu\text{A}$		1.1	1.5	3	V
			$T_J = 125^\circ\text{C}$	0.7	1.1	2.2	
		$V_{DS} = V_{GS}$, $I_D = 10\text{ mA}$		1.4	1.85	3	
			$T_J = 125^\circ\text{C}$	1	1.5	2.2	
$R_{DS(on)}$	Static Drain-Source On-Resistance	$V_{GS} = 10\text{ V}$, $I_D = 25\text{ A}$			0.019	0.022	Ω
			$T_J = 125^\circ\text{C}$			0.028	
		$V_{GS} = 4.5\text{ V}$, $I_D = 10\text{ A}$			0.031	0.04	
$I_{D(on)}$	On-State Drain Current	$V_{GS} = 10\text{ V}$, $V_{DS} = 10\text{ V}$	60			A	
		$V_{GS} = 4.5\text{ V}$, $V_{DS} = 10\text{ V}$	15				
g_{FS}	Forward Transconductance	$V_{DS} = 10\text{ V}$, $I_D = 25\text{ A}$		18		S	
DYNAMIC CHARACTERISTICS							
C_{iss}	Input Capacitance	$V_{DS} = 15\text{ V}$, $V_{GS} = 0\text{ V}$, $f = 1.0\text{ MHz}$		1100		pF	
C_{oss}	Output Capacitance			540		pF	
C_{rss}	Reverse Transfer Capacitance			175		pF	
SWITCHING CHARACTERISTICS (Note 2)							
$t_{D(on)}$	Turn - On Delay Time	$V_{DD} = 15\text{ V}$, $I_D = 25\text{ A}$, $V_{GS} = 10\text{ V}$, $R_{GEN} = 24\ \Omega$		15	30	ns	
t_r	Turn - On Rise Time			70	110	ns	
$t_{D(off)}$	Turn - Off Delay Time			90	150	ns	
t_f	Turn - Off Fall Time			80	130	ns	
Q_g	Total Gate Charge	$V_{DS} = 10\text{ V}$, $I_D = 25\text{ A}$, $V_{GS} = 10\text{ V}$		28	40	nC	
Q_{gs}	Gate-Source Charge			5	7	nC	
Q_{gd}	Gate-Drain Charge			7	10	nC	
DRAIN-SOURCE DIODE CHARACTERISTICS AND MAXIMUM RATINGS							
I_S	Maximum Continuous Drain-Source Diode Forward Current				25	A	
V_{SD}	Drain-Source Diode Forward Voltage	$V_{GS} = 0\text{ V}$, $I_S = 25\text{ A}$ (Note 2)			1.3	V	

Note:

- Maximum DC current limited by the package.
- Pulse Test: Pulse Width $\leq 300\ \mu\text{s}$, Duty Cycle $\leq 2.0\%$.

Typical Electrical Characteristics

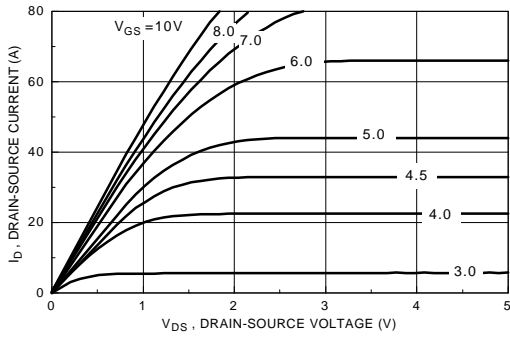

Figure 1. On-Region Characteristics.

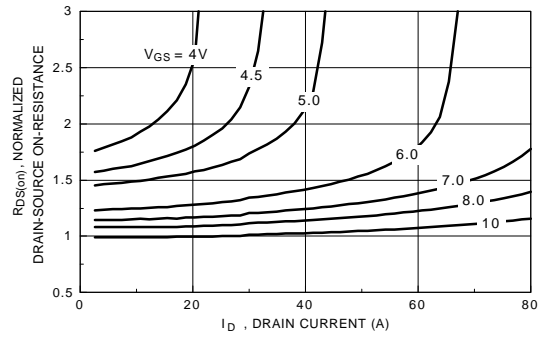

Figure 2. On-Resistance Variation with Gate Voltage and Drain Current.

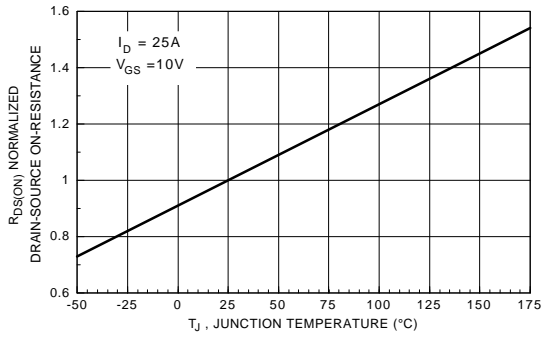

Figure 3. On-Resistance Variation with Temperature.

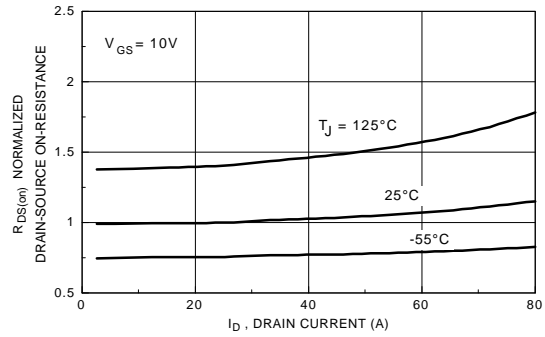

Figure 4. On-Resistance Variation with Drain Current and Temperature.

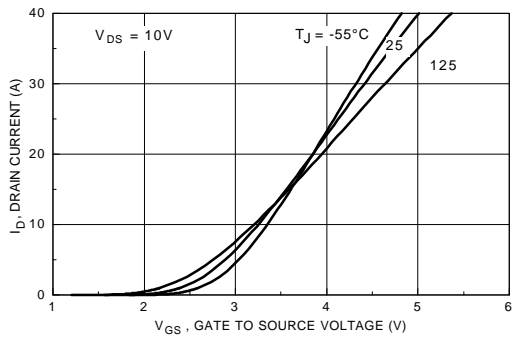

Figure 5. Drain Current Variation with Gate Voltage and Temperature.

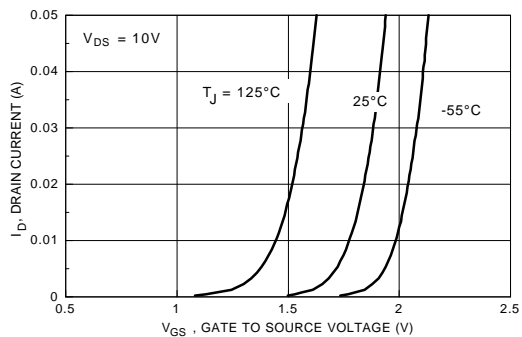

Figure 6. Sub-threshold Drain Current Variation with Gate Voltage and Temperature.

Typical Electrical Characteristics (continued)

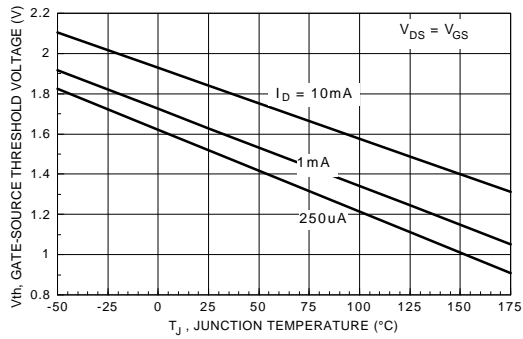

Figure 7. Gate Threshold Variation with Temperature

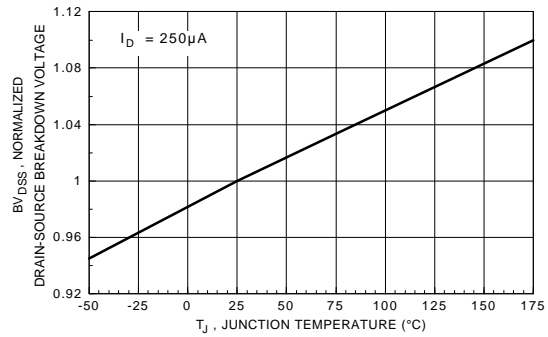

Figure 8. Breakdown Voltage Variation with Temperature.

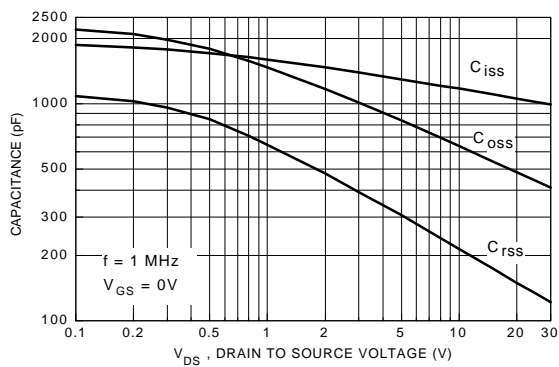

Figure 9. Capacitance Characteristics.

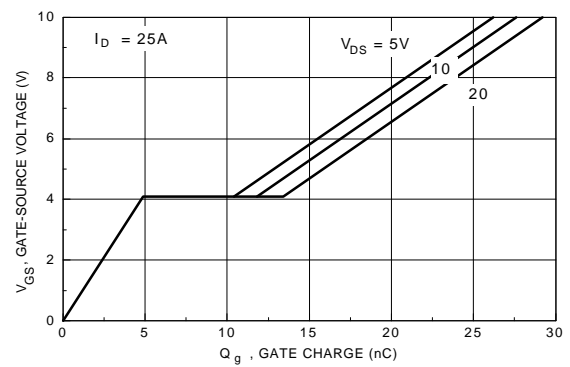

Figure 10. Gate Charge Characteristics.

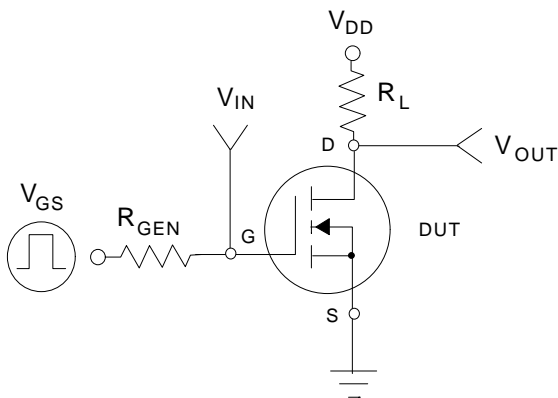

Figure 11. Switching Test Circuit

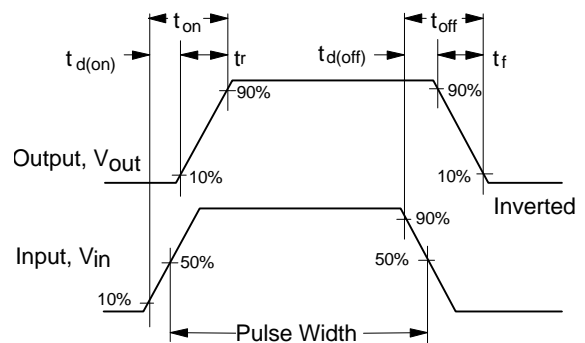

Figure 12. Switching Waveforms

Typical Electrical Characteristics (continued)

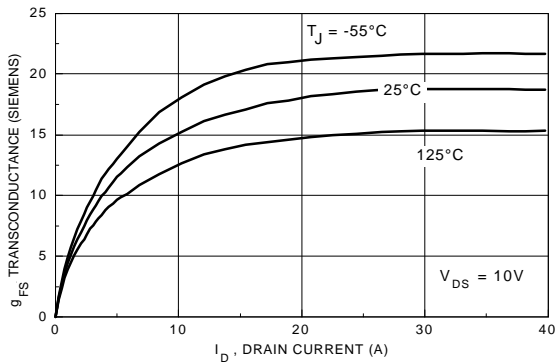

Figure 13. Transconductance Variation with Drain Current and Temperature

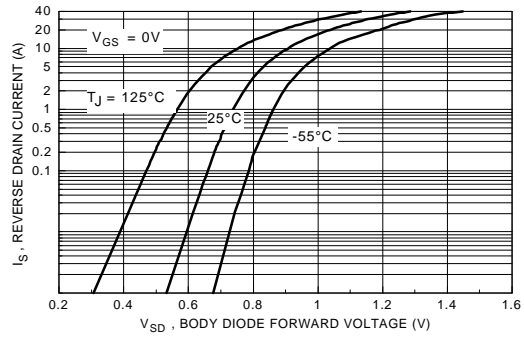

Figure 14. Body Diode Forward Voltage Variation with Current and Temperature

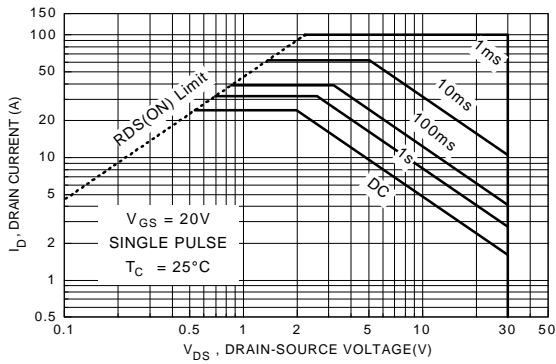

Figure 15. Maximum Safe Operating Area

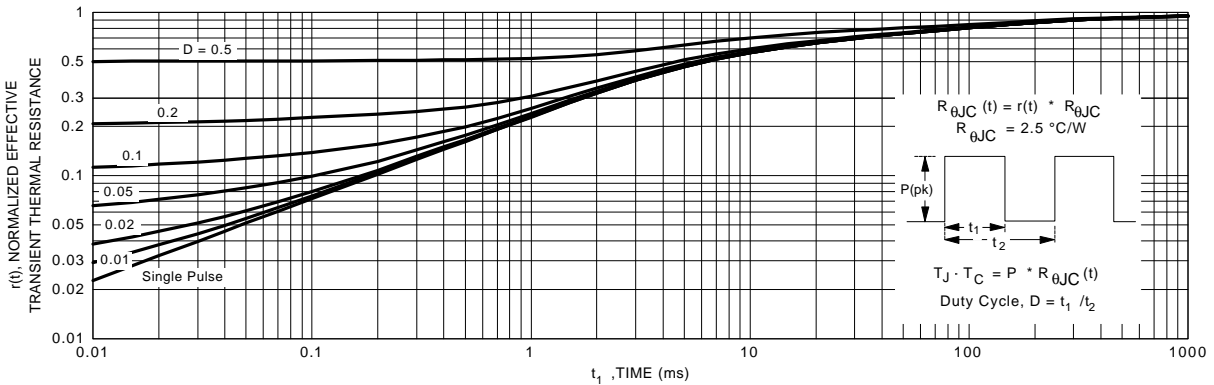

Figure 16. Transient Thermal Response Curve