



# FDD6635

## 35V N-Channel PowerTrench® MOSFET

### General Description

This N-Channel MOSFET has been produced using Fairchild Semiconductor's proprietary PowerTrench technology to deliver low R<sub>DS(on)</sub> and optimized B<sub>VDS</sub> capability to offer superior performance benefit in the applications.

### Applications

- Inverter
- Power Supplies

### Features

- 59 A, 35 V  $R_{DS(ON)} = 10\text{ m}\Omega @ V_{GS} = 10\text{ V}$   
 $R_{DS(ON)} = 13\text{ m}\Omega @ V_{GS} = 4.5\text{ V}$
- Fast Switching
- RoHS compliant

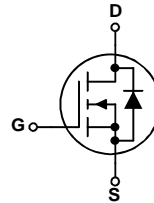
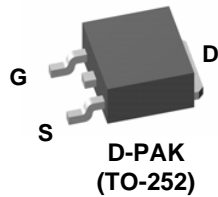

### Absolute Maximum Ratings T<sub>A</sub>=25°C unless otherwise noted

Symbol	Parameter	Ratings	Units
V <sub>DSS</sub>	Drain-Source Voltage	35	V
V <sub>DS(Avalanche)</sub>	Drain-Source Avalanche Voltage (maximum) (Note 4)	40	V
V <sub>GSS</sub>	Gate-Source Voltage	±20	V
I <sub>D</sub>	Continuous Drain Current @ T <sub>C</sub> =25°C (Note 3) @ T <sub>A</sub> =25°C (Note 1a) Pulsed (Note 1a)	59	A
		15	
		100	
E <sub>AS</sub>	Single Pulse Avalanche Energy (Note 5)	113	mJ
P <sub>D</sub>	Power Dissipation @ T <sub>C</sub> =25°C (Note 3) @ T <sub>A</sub> =25°C (Note 1a) @ T <sub>A</sub> =25°C (Note 1b)	55	W
		3.8	
		1.6	
T <sub>J</sub> , T <sub>STG</sub>	Operating and Storage Junction Temperature Range	-55 to +150	°C

### Thermal Characteristics

Symbol	Parameter	Units
R <sub>θJC</sub>	Thermal Resistance, Junction-to-Case (Note 1)	2.7 °C/W
R <sub>θJA</sub>	Thermal Resistance, Junction-to-Ambient (Note 1a)	40 °C/W
R <sub>θJA</sub>	Thermal Resistance, Junction-to-Ambient (Note 1b)	96 °C/W

### Package Marking and Ordering Information

Device Marking	Device	Package	Reel Size	Tape width	Quantity
FDD6635	FDD6635	D-PAK (TO-252)	13"	12mm	2500 units

Electrical Characteristics <span style="float: right;"><small>T<sub>A</sub> = 25°C unless otherwise noted</small></span>							
Symbol	Parameter	Test Conditions	Min	Typ	Max	Units	
<b>Off Characteristics</b> (Note 2)							
BV <sub>DSS</sub>	Drain–Source Breakdown Voltage	V <sub>GS</sub> = 0 V, I <sub>D</sub> = 250 μA	35			V	
$\frac{\Delta BV_{DSS}}{\Delta T_J}$	Breakdown Voltage Temperature Coefficient	I <sub>D</sub> = 250 μA, Referenced to 25°C		32		mV/°C	
I <sub>DSS</sub>	Zero Gate Voltage Drain Current	V <sub>DS</sub> = 28 V, V <sub>GS</sub> = 0 V			1	μA	
I <sub>GSS</sub>	Gate–Body Leakage	V <sub>GS</sub> = ±20 V, V <sub>DS</sub> = 0 V			±100	nA	
<b>On Characteristics</b> (Note 2)							
V <sub>GS(th)</sub>	Gate Threshold Voltage	V <sub>DS</sub> = V <sub>GS</sub> , I <sub>D</sub> = 250 μA	1	1.9	3	V	
$\frac{\Delta V_{GS(th)}}{\Delta T_J}$	Gate Threshold Voltage Temperature Coefficient	I <sub>D</sub> = 250 μA, Referenced to 25°C		–5		mV/°C	
R <sub>DS(on)</sub>	Static Drain–Source On–Resistance	V <sub>GS</sub> = 10 V, I <sub>D</sub> = 15 A V <sub>GS</sub> = 4.5 V, I <sub>D</sub> = 13 A V <sub>GS</sub> = 10 V, I <sub>D</sub> = 15 A, T <sub>J</sub> = 125°C		8.2 10.2 12.4	10 13 16	mΩ	
g <sub>FS</sub>	Forward Transconductance	V <sub>DS</sub> = 5 V, I <sub>D</sub> = 15 A		53		S	
<b>Dynamic Characteristics</b>							
C <sub>iss</sub>	Input Capacitance	V <sub>DS</sub> = 20 V, V <sub>GS</sub> = 0 V, f = 1.0 MHz		1400		pF	
C <sub>oss</sub>	Output Capacitance			317		pF	
C <sub>rss</sub>	Reverse Transfer Capacitance			137		pF	
R <sub>G</sub>	Gate Resistance		V <sub>GS</sub> = 15 mV, f = 1.0 MHz		1.4		Ω
<b>Switching Characteristics</b> (Note 2)							
t <sub>d(on)</sub>	Turn–On Delay Time	V <sub>DD</sub> = 20 V, I <sub>D</sub> = 1 A, V <sub>GS</sub> = 10 V, R <sub>GEN</sub> = 6 Ω		11	20	ns	
t <sub>r</sub>	Turn–On Rise Time			6	12	ns	
t <sub>d(off)</sub>	Turn–Off Delay Time			28	45	ns	
t <sub>f</sub>	Turn–Off Fall Time			14	25	ns	
Q <sub>g (TOT)</sub>	Total Gate Charge, V <sub>GS</sub> = 10V	V <sub>DS</sub> = 20 V, I <sub>D</sub> = 15 A		26	36	nC	
Q <sub>g</sub>	Total Gate Charge, V <sub>GS</sub> = 5V			13	18	nC	
Q <sub>gs</sub>	Gate–Source Charge			3.9		nC	
Q <sub>gd</sub>	Gate–Drain Charge			5.3		nC	

### Electrical Characteristics

$T_A = 25^\circ\text{C}$  unless otherwise noted

Symbol	Parameter	Test Conditions	Min	Typ	Max	Units
<b>Drain-Source Diode Characteristics</b>						
$V_{SD}$	Drain-Source Diode Forward Voltage	$V_{GS} = 0\text{ V}, I_S = 15\text{ A}$ (Note 2)		0.8	1.2	V
$t_{rr}$	Diode Reverse Recovery Time	$I_F = 15\text{ A}, diF/dt = 100\text{ A}/\mu\text{s}$		26		ns
$Q_{rr}$	Diode Reverse Recovery Charge			16		nC

**Notes:**

1.  $R_{\theta JA}$  is the sum of the junction-to-case and case-to-ambient thermal resistance where the case thermal reference is defined as the solder mounting surface of the drain pins.  $R_{\theta JC}$  is guaranteed by design while  $R_{\theta CA}$  is determined by the user's board design.



a)  $R_{\theta JA} = 40^\circ\text{C/W}$  when mounted on a  $1\text{ in}^2$  pad of 2 oz copper



b)  $R_{\theta JA} = 96^\circ\text{C/W}$  when mounted on a minimum pad.

Scale 1 : 1 on letter size paper

2. Pulse Test: Pulse Width < 300 $\mu\text{s}$ , Duty Cycle < 2.0%

3. Maximum current is calculated as:

$$\sqrt{\frac{P_D}{R_{DS(on)}}}$$

where  $P_D$  is maximum power dissipation at  $T_C = 25^\circ\text{C}$  and  $R_{DS(on)}$  is at  $T_{J(max)}$  and  $V_{GS} = 10\text{V}$ . Package current limitation is 21A

4. BV(avalanche) Single-Pulse rating is guaranteed if device is operated within the UIS SOA boundary of the device.

5. Starting  $T_J = 25^\circ\text{C}$ ,  $L = 1\text{mH}$ ,  $I_{AS} = 15\text{A}$ ,  $V_{DD} = 35\text{V}$ ,  $V_{GS} = 10\text{V}$

## Typical Characteristics

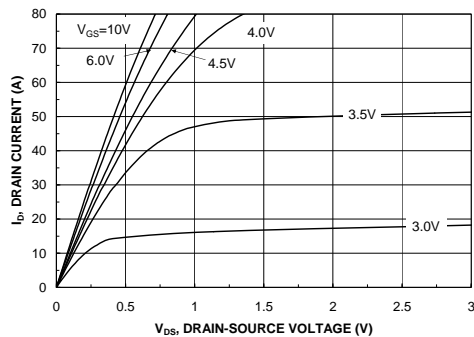

Figure 1. On-Region Characteristics

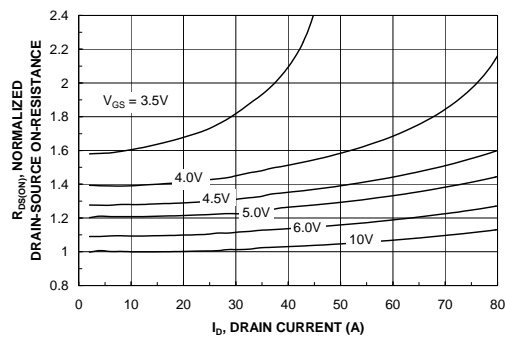

Figure 2. On-Resistance Variation with Drain Current and Gate Voltage

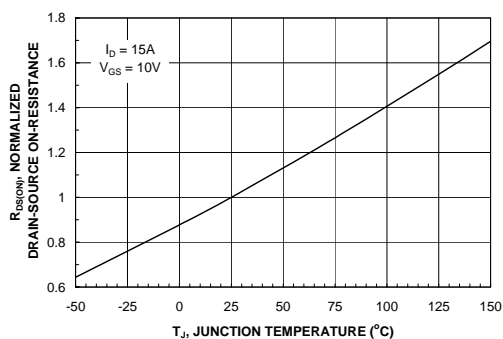

Figure 3. On-Resistance Variation with Temperature

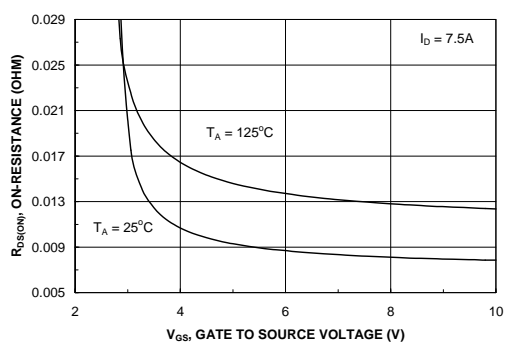

Figure 4. On-Resistance Variation with Gate-to-Source Voltage

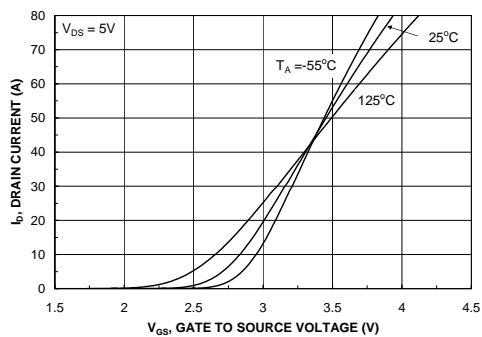

Figure 5. Transfer Characteristics

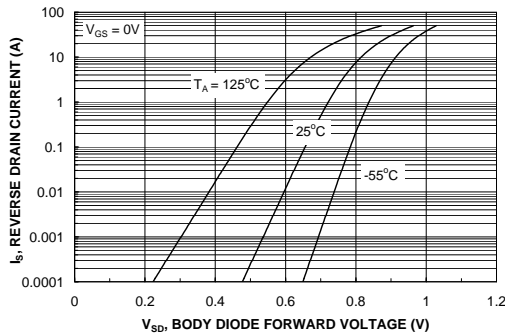

Figure 6. Body Diode Forward Voltage Variation with Source Current and Temperature

## Typical Characteristics

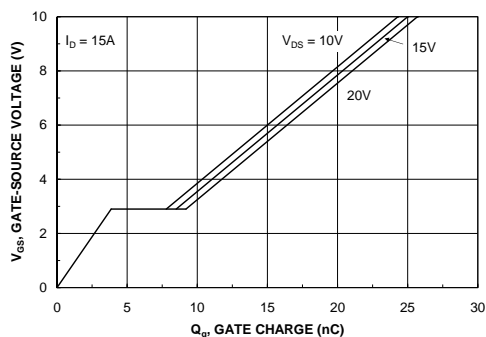

Figure 7. Gate Charge Characteristics

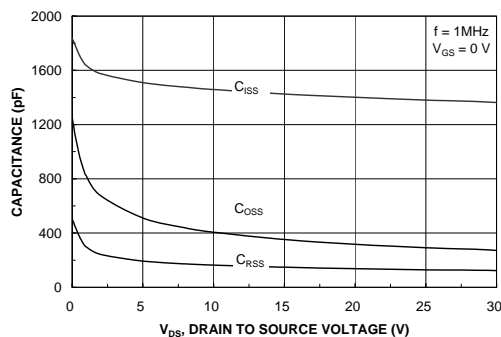

Figure 8. Capacitance Characteristics

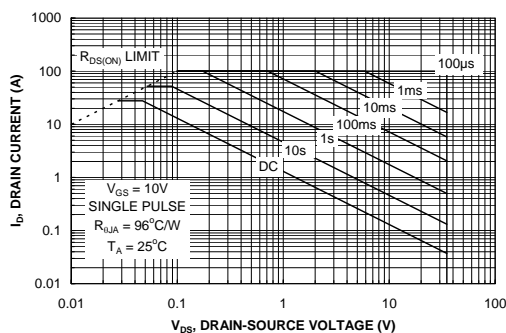

Figure 9. Maximum Safe Operating Area

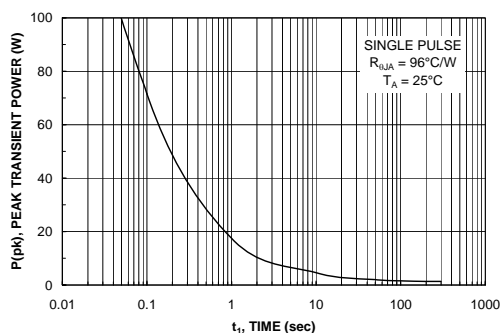

Figure 10. Single Pulse Maximum Power Dissipation

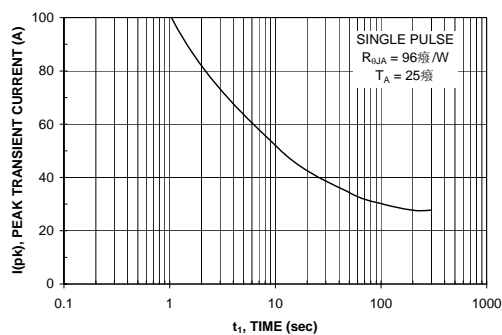

Figure 11. Single Pulse Maximum Peak Current

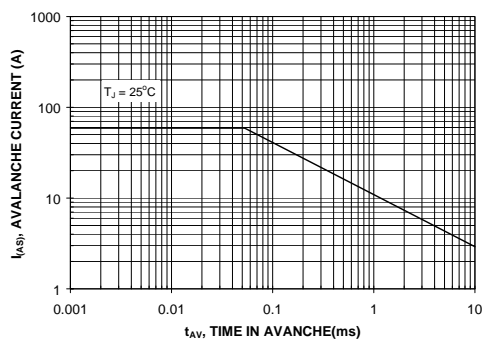
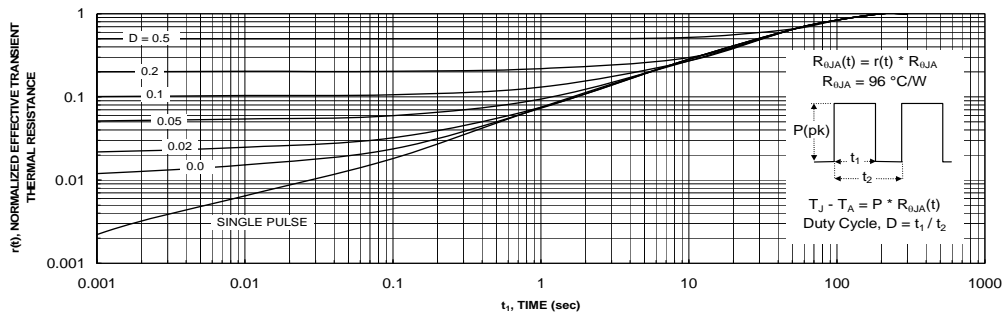

Figure 12. Unclamped Inductive Switching Capability

### Typical Characteristics



**Figure 13. Transient Thermal Response Curve**

Thermal characterization performed using the conditions described in Note 1b.  
 Transient thermal response will change depending on the circuit board design.

### Test Circuits and Waveforms

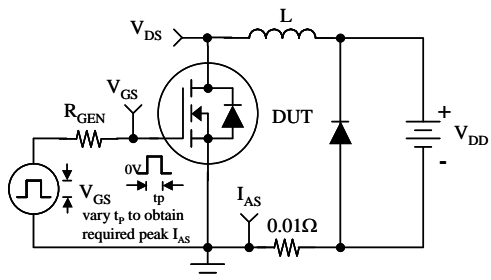

Figure 14. Unclamped Inductive Load Test Circuit

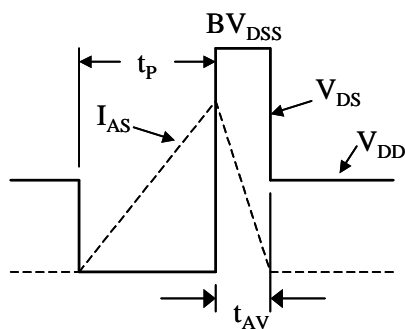

Figure 15. Unclamped Inductive Waveforms

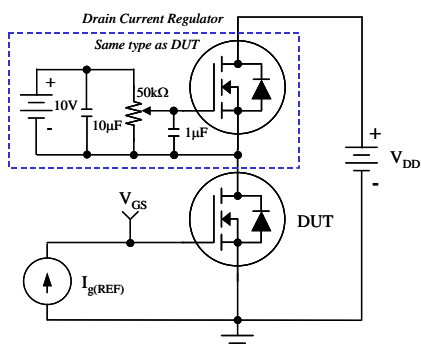

Figure 16. Gate Charge Test Circuit

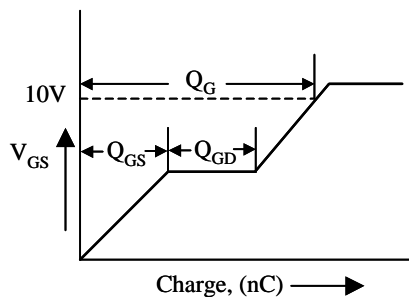

Figure 17. Gate Charge Waveform

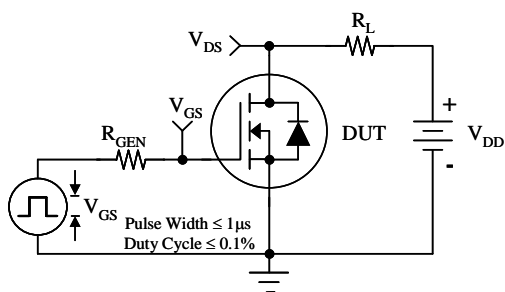

Figure 18. Switching Time Test Circuit

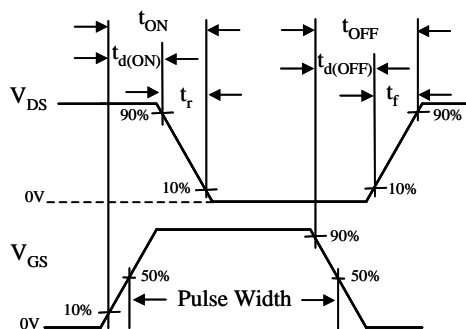

Figure 19. Switching Time Waveforms

## TRADEMARKS

The following are registered and unregistered trademarks Fairchild Semiconductor owns or is authorized to use and is not intended to be an exhaustive list of all such trademarks.

ACE <sub>x</sub> <sup>TM</sup>	FACT Quiet Series <sup>TM</sup>	OCX <sup>TM</sup>	SILENT SWITCHER <sup>®</sup>	UniFET <sup>TM</sup>
ActiveArray <sup>TM</sup>	GlobalOptoisolator <sup>TM</sup>	OCXPro <sup>TM</sup>	SMART START <sup>TM</sup>	VCX <sup>TM</sup>
Bottomless <sup>TM</sup>	GTO <sup>TM</sup>	OPTOLOGIC <sup>®</sup>	SPM <sup>TM</sup>	Wire <sup>TM</sup>
Build it Now <sup>TM</sup>	HiSeC <sup>TM</sup>	OPTOPLANAR <sup>TM</sup>	Stealth <sup>TM</sup>	
CoolFET <sup>TM</sup>	I <sup>2</sup> C <sup>TM</sup>	PACMAN <sup>TM</sup>	SuperFET <sup>TM</sup>	
CROSSVOLT <sup>TM</sup>	<i>i-Lo</i> <sup>TM</sup>	POP <sup>TM</sup>	SuperSOT <sup>TM</sup> -3	
DOME <sup>TM</sup>	ImpliedDisconnect <sup>TM</sup>	Power247 <sup>TM</sup>	SuperSOT <sup>TM</sup> -6	
EcoSPARK <sup>TM</sup>	IntelliMAX <sup>TM</sup>	PowerEdge <sup>TM</sup>	SuperSOT <sup>TM</sup> -8	
E <sup>2</sup> CMOS <sup>TM</sup>	ISOPLANAR <sup>TM</sup>	PowerSaver <sup>TM</sup>	SyncFET <sup>TM</sup>	
EnSigna <sup>TM</sup>	LittleFET <sup>TM</sup>	PowerTrench <sup>®</sup>	TCM <sup>TM</sup>	
FACT <sup>®</sup>	MICROCOUPLER <sup>TM</sup>	QFET <sup>®</sup>	TinyBoost <sup>TM</sup>	
FAST <sup>®</sup>	MicroFET <sup>TM</sup>	QS <sup>TM</sup>	TinyBuck <sup>TM</sup>	
FASTr <sup>TM</sup>	MicroPak <sup>TM</sup>	QT Optoelectronics <sup>TM</sup>	TinyPWM <sup>TM</sup>	
FPST <sup>TM</sup>	MICROWIRE <sup>TM</sup>	Quiet Series <sup>TM</sup>	TinyPower <sup>TM</sup>	
FRFET <sup>TM</sup>	MSX <sup>TM</sup>	RapidConfigure <sup>TM</sup>	TinyLogic <sup>®</sup>	
	MSXPro <sup>TM</sup>	RapidConnect <sup>TM</sup>	TINYOPTO <sup>TM</sup>	
		μSerDes <sup>TM</sup>	TruTranslation <sup>TM</sup>	
		ScalarPump <sup>TM</sup>	UHC <sup>®</sup>	
Across the board. Around the world. <sup>TM</sup>				
The Power Franchise <sup>®</sup>				
Programmable Active Droop <sup>TM</sup>				

### DISCLAIMER

FAIRCHILD SEMICONDUCTOR RESERVES THE RIGHT TO MAKE CHANGES WITHOUT FURTHER NOTICE TO ANY PRODUCTS HEREIN TO IMPROVE RELIABILITY, FUNCTION OR DESIGN. FAIRCHILD DOES NOT ASSUME ANY LIABILITY ARISING OUT OF THE APPLICATION OR USE OF ANY PRODUCT OR CIRCUIT DESCRIBED HEREIN; NEITHER DOES IT CONVEY ANY LICENSE UNDER ITS PATENT RIGHTS, NOR THE RIGHTS OF OTHERS. THESE SPECIFICATIONS DO NOT EXPAND THE TERMS OF FAIRCHILD'S WORLDWIDE TERMS AND CONDITIONS, SPECIFICALLY THE WARRANTY THEREIN, WHICH COVERS THESE PRODUCTS.

### LIFE SUPPORT POLICY

FAIRCHILD'S PRODUCTS ARE NOT AUTHORIZED FOR USE AS CRITICAL COMPONENTS IN LIFE SUPPORT DEVICES OR SYSTEMS WITHOUT THE EXPRESS WRITTEN APPROVAL OF FAIRCHILD SEMICONDUCTOR CORPORATION.

As used herein:

- Life support devices or systems are devices or systems which, (a) are intended for surgical implant into the body, or (b) support or sustain life, or (c) whose failure to perform when properly used in accordance with instructions for use provided in the labeling, can be reasonably expected to result in significant injury to the user.
- A critical component is any component of a life support device or system whose failure to perform can be reasonably expected to cause the failure of the life support device or system, or to affect its safety or effectiveness.

### PRODUCT STATUS DEFINITIONS

#### Definition of Terms

Datasheet Identification	Product Status	Definition
Advance Information	Formative or In Design	This datasheet contains the design specifications for product development. Specifications may change in any manner without notice.
Preliminary	First Production	This datasheet contains preliminary data, and supplementary data will be published at a later date. Fairchild Semiconductor reserves the right to make changes at any time without notice in order to improve design.
No Identification Needed	Full Production	This datasheet contains final specifications. Fairchild Semiconductor reserves the right to make changes at any time without notice in order to improve design.
Obsolete	Not In Production	This datasheet contains specifications on a product that has been discontinued by Fairchild semiconductor. The datasheet is printed for reference information only.

Rev. I22