

# IRF9956

HEXFET® Power MOSFET

- Generation V Technology
- Ultra Low On-Resistance
- Dual N-Channel MOSFET
- Surface Mount
- Very Low Gate Charge and Switching Losses
- Fully Avalanche Rated

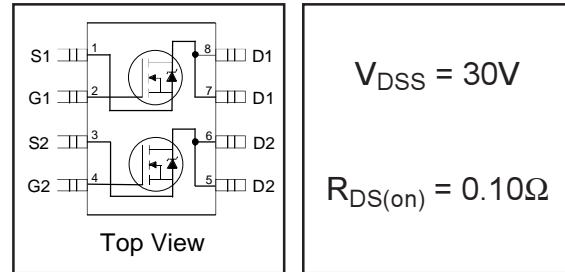

## Description

Fifth Generation HEXFETs from International Rectifier utilize advanced processing techniques to achieve extremely low on-resistance per silicon area. This benefit, combined with the fast switching speed and ruggedized device design that HEXFET Power MOSFETs are well known for, provides the designer with an extremely efficient and reliable device for use in a wide variety of applications.

The SO-8 has been modified through a customized leadframe for enhanced thermal characteristics and multiple-die capability making it ideal in a variety of power applications. With these improvements, multiple devices can be used in an application with dramatically reduced board space. The package is designed for vapor phase, infra red, or wave soldering techniques.

Recommended upgrade: IRF7303 or IRF7313  
Lower profile/smaller equivalent: IRF7503

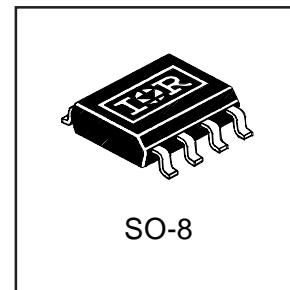

## Absolute Maximum Ratings ( $T_A = 25^\circ\text{C}$ Unless Otherwise Noted)

	Symbol	Maximum	Units
Drain-Source Voltage	$V_{DS}$	30	V
Gate-Source Voltage	$V_{GS}$	$\pm 20$	
Continuous Drain Current <sup>①</sup>	$I_D$	$T_A = 25^\circ\text{C}$	A
		$T_A = 70^\circ\text{C}$	
Pulsed Drain Current	$I_{DM}$	16	
Continuous Source Current (Diode Conduction)	$I_S$	1.7	
Maximum Power Dissipation <sup>②</sup>	$P_D$	$T_A = 25^\circ\text{C}$	W
		$T_A = 70^\circ\text{C}$	
Single Pulse Avalanche Energy <sup>②</sup>	$E_{AS}$	44	mJ
Avalanche Current	$I_{AR}$	2.0	A
Repetitive Avalanche Energy	$E_{AR}$	0.20	mJ
Peak Diode Recovery $dv/dt$ <sup>③</sup>	$dv/dt$	5.0	V/ ns
Junction and Storage Temperature Range	$T_J, T_{STG}$	-55 to + 150	$^\circ\text{C}$

## Thermal Resistance Ratings

Parameter	Symbol	Limit	Units
Maximum Junction-to-Ambient <sup>④</sup>	$R_{\theta JA}$	62.5	$^\circ\text{C/W}$

04/29/03

## Electrical Characteristics @ T<sub>J</sub> = 25°C (unless otherwise specified)

	Parameter	Min.	Typ.	Max.	Units	Conditions
V <sub>(BR)DSS</sub>	Drain-to-Source Breakdown Voltage	30	—	—	V	V <sub>GS</sub> = 0V, I <sub>D</sub> = 250μA
ΔV <sub>(BR)DSS</sub> /ΔT <sub>J</sub>	Breakdown Voltage Temp. Coefficient	—	0.015	—	V/°C	Reference to 25°C, I <sub>D</sub> = 1mA
R <sub>DS(on)</sub>	Static Drain-to-Source On-Resistance	—	0.06	0.10	Ω	V <sub>GS</sub> = 10V, I <sub>D</sub> = 2.2A ④
		—	0.09	0.20		V <sub>GS</sub> = 4.5V, I <sub>D</sub> = 1.0A ④
V <sub>GS(th)</sub>	Gate Threshold Voltage	1.0	—	—	V	V <sub>DS</sub> = V <sub>GS</sub> , I <sub>D</sub> = 250μA
g <sub>fs</sub>	Forward Transconductance	—	12	—	S	V <sub>DS</sub> = 15V, I <sub>D</sub> = 3.5A
I <sub>DSS</sub>	Drain-to-Source Leakage Current	—	—	2.0	μA	V <sub>DS</sub> = 24V, V <sub>GS</sub> = 0V
		—	—	25		V <sub>DS</sub> = 24V, V <sub>GS</sub> = 0V, T <sub>J</sub> = 125°C
I <sub>GSS</sub>	Gate-to-Source Forward Leakage	—	—	100	nA	V <sub>GS</sub> = 24V
	Gate-to-Source Reverse Leakage	—	—	-100		V <sub>GS</sub> = -24V
Q <sub>g</sub>	Total Gate Charge	—	6.9	14	nC	I <sub>D</sub> = 1.8A
Q <sub>gs</sub>	Gate-to-Source Charge	—	1.0	2.0		V <sub>DS</sub> = 10V
Q <sub>gd</sub>	Gate-to-Drain ("Miller") Charge	—	1.8	3.5		V <sub>GS</sub> = 10V, See Fig. 10 ④
t <sub>d(on)</sub>	Turn-On Delay Time	—	6.2	12	ns	V <sub>DD</sub> = 10V
t <sub>r</sub>	Rise Time	—	8.8	18		I <sub>D</sub> = 1.0A
t <sub>d(off)</sub>	Turn-Off Delay Time	—	13	26		R <sub>G</sub> = 6.0Ω
t <sub>f</sub>	Fall Time	—	3.0	6.0		R <sub>D</sub> = 10Ω ④
C <sub>iss</sub>	Input Capacitance	—	190	—	pF	V <sub>GS</sub> = 0V
C <sub>oss</sub>	Output Capacitance	—	120	—		V <sub>DS</sub> = 15V
C <sub>rss</sub>	Reverse Transfer Capacitance	—	61	—		f = 1.0MHz, See Fig. 9

## Source-Drain Ratings and Characteristics

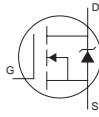
	Parameter	Min.	Typ.	Max.	Units	Conditions
I <sub>S</sub>	Continuous Source Current (Body Diode)	—	—	1.7	A	MOSFET symbol showing the integral reverse p-n junction diode. 
I <sub>SM</sub>	Pulsed Source Current (Body Diode) ①	—	—	16		
V <sub>SD</sub>	Diode Forward Voltage	—	0.82	1.2	V	T <sub>J</sub> = 25°C, I <sub>S</sub> = 1.25A, V <sub>GS</sub> = 0V ③
t <sub>rr</sub>	Reverse Recovery Time	—	27	53	ns	T <sub>J</sub> = 25°C, I <sub>F</sub> = 1.25A
Q <sub>rr</sub>	Reverse Recovery Charge	—	28	57	nC	di/dt = 100A/μs ③

### Notes:

- ① Repetitive rating; pulse width limited by max. junction temperature. ( See fig. 11 )
- ② Starting T<sub>J</sub> = 25°C, L = 22mH  
R<sub>G</sub> = 25Ω, I<sub>AS</sub> = 2.0A.
- ③ I<sub>SD</sub> ≤ 2.0A, di/dt ≤ 100A/μs, V<sub>DD</sub> ≤ V<sub>(BR)DSS</sub>,  
T<sub>J</sub> ≤ 150°C
- ④ Pulse width ≤ 300μs; duty cycle ≤ 2%.
- ⑤ Surface mounted on FR-4 board, t ≤ 10sec.

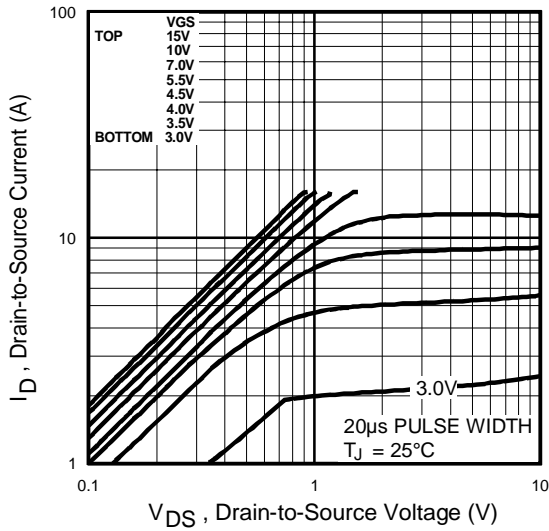

Fig 1. Typical Output Characteristics

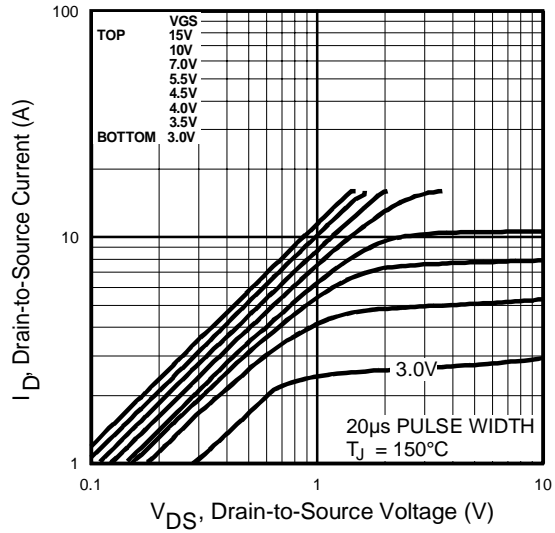

Fig 2. Typical Output Characteristics

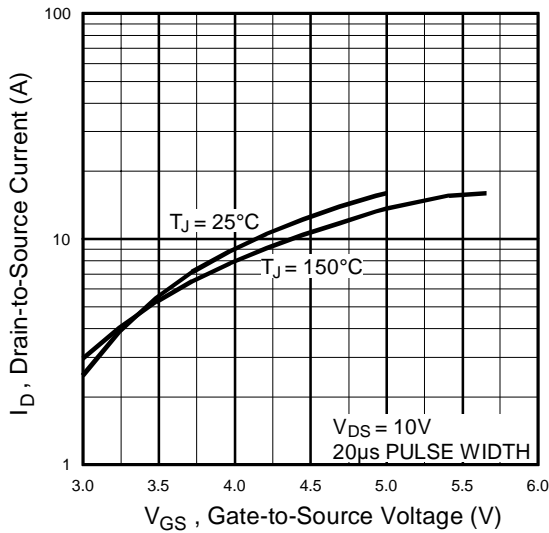

Fig 3. Typical Transfer Characteristics

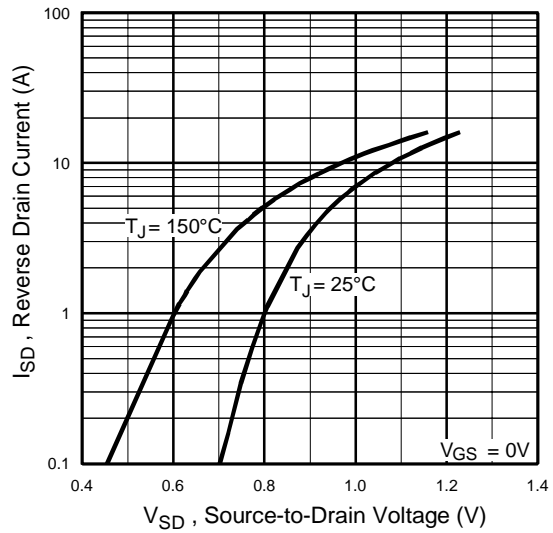
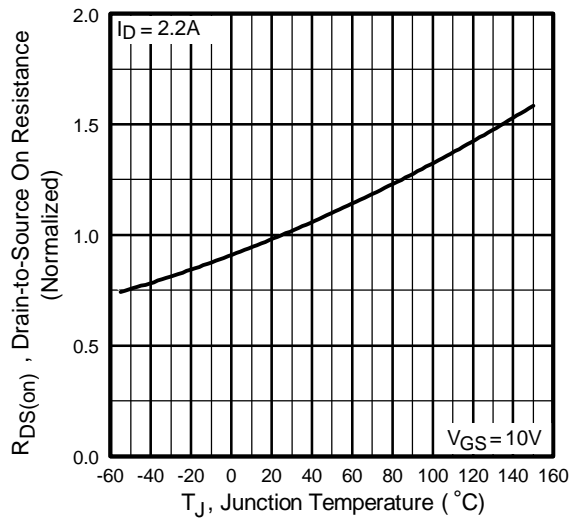
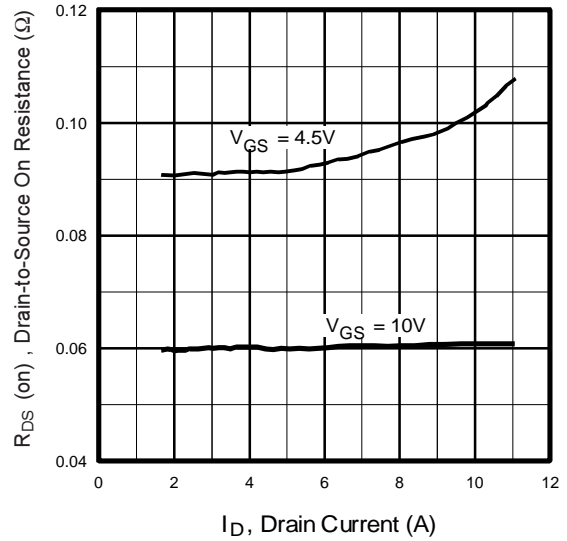

Fig 4. Typical Source-Drain Diode Forward Voltage



**Fig 4.** Normalized On-Resistance Vs. Temperature



**Fig 6.** Typical On-Resistance Vs. Drain Current

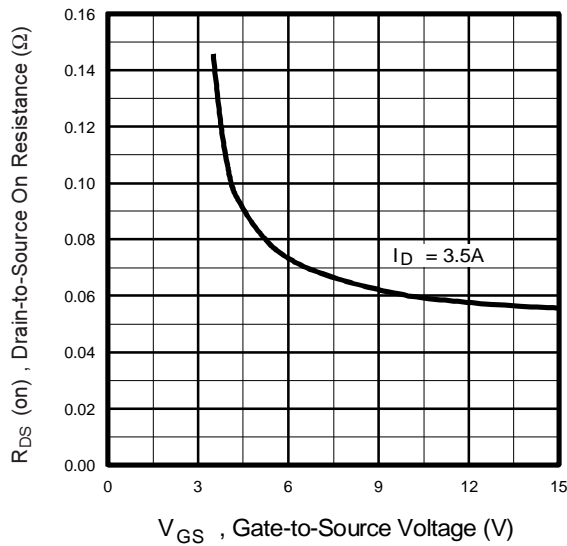

**Fig 7.** Typical On-Resistance Vs. Gate Voltage

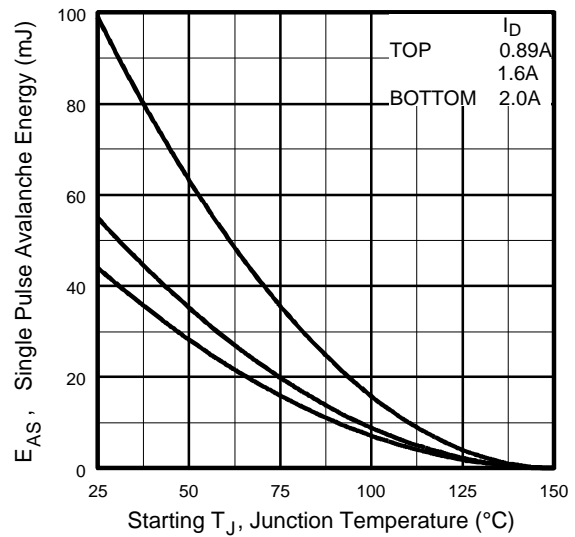

**Fig 8.** Maximum Avalanche Energy Vs. Drain Current

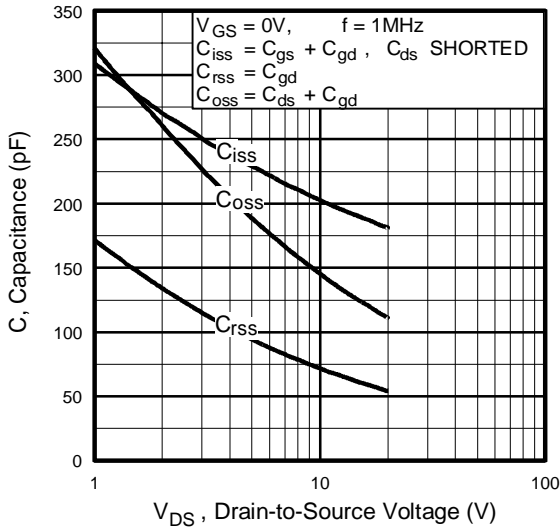

Fig 9. Typical Capacitance Vs. Drain-to-Source Voltage

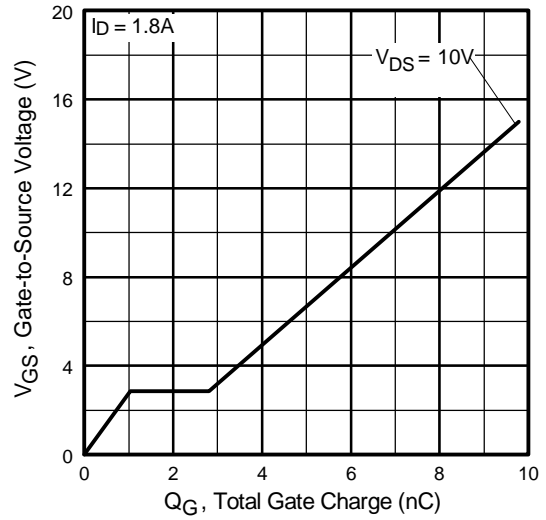

Fig 10. Typical Gate Charge Vs. Gate-to-Source Voltage

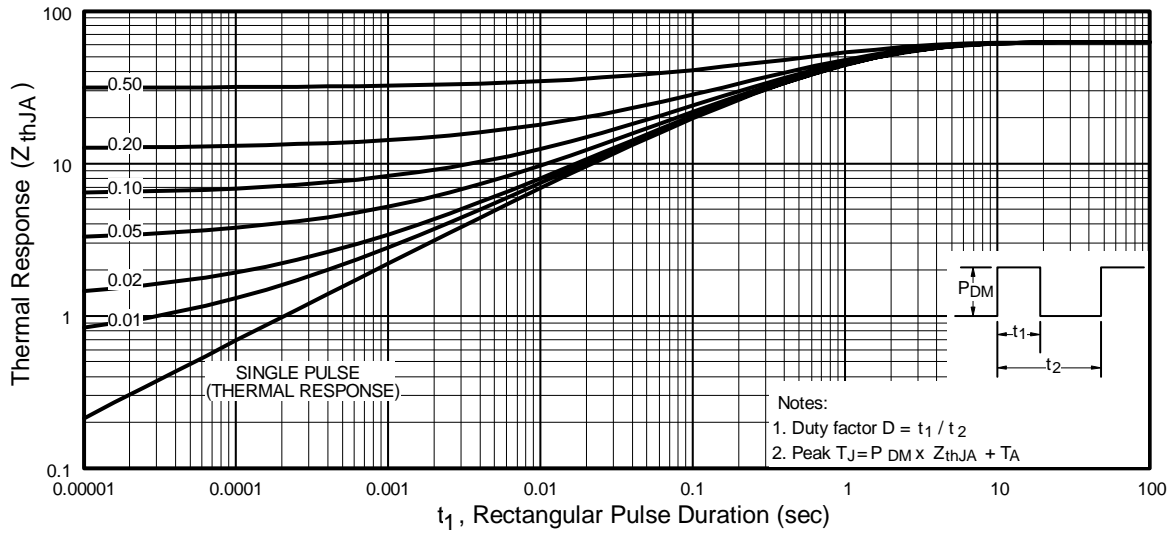

Fig 11. Maximum Effective Transient Thermal Impedance, Junction-to-Ambient

# IRF9956

International  
**IR** Rectifier

## Package Outline

### S08 Outline

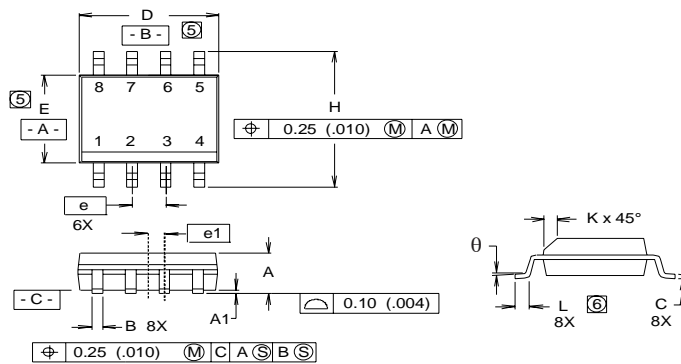

DIM	INCHES		MILLIMETERS	
	MIN	MAX	MIN	MAX
A	.0532	.0688	1.35	1.75
A1	.0040	.0098	0.10	0.25
B	.014	.018	0.36	0.46
C	.0075	.0098	0.19	0.25
D	.189	.196	4.80	4.98
E	.150	.157	3.81	3.99
e	.050 BASIC		1.27 BASIC	
e1	.025 BASIC		0.635 BASIC	
H	.2284	.2440	5.80	6.20
K	.011	.019	0.28	0.48
L	0.16	.050	0.41	1.27
θ	0°	8°	0°	8°

#### RECOMMENDED FOOTPRINT

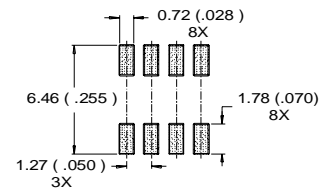

#### NOTES:

1. DIMENSIONING AND TOLERANCING PER ANSI Y14.5M-1982.
2. CONTROLLING DIMENSION : INCH.
3. DIMENSIONS ARE SHOWN IN MILLIMETERS (INCHES).
4. OUTLINE CONFORMS TO JEDEC OUTLINE MS-012AA.
5. DIMENSION DOES NOT INCLUDE MOLD PROTRUSIONS  
MOLD PROTRUSIONS NOT TO EXCEED 0.25 (.006).
6. DIMENSIONS IS THE LENGTH OF LEAD FOR SOLDERING TO A SUBSTRATE..

## Part Marking Information

### S08

EXAMPLE : THIS IS AN IRF7101

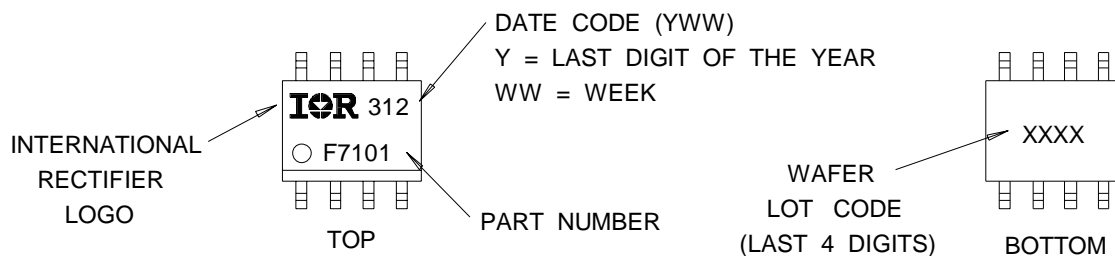

## Tape & Reel Information

**S08**

Dimensions are shown in millimeters (inches)

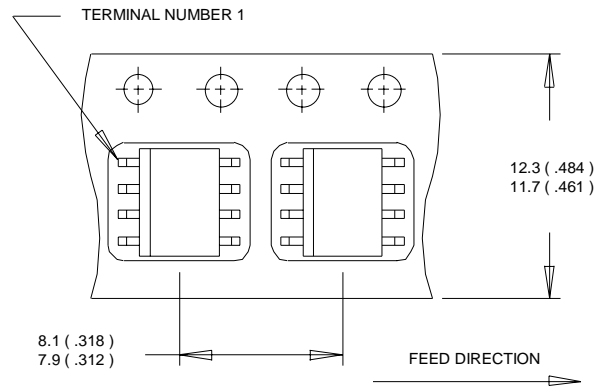

**NOTES:**

1. CONTROLLING DIMENSION : MILLIMETER.
2. ALL DIMENSIONS ARE SHOWN IN MILLIMETERS(INCHES).
3. OUTLINE CONFORMS TO EIA-481 & EIA-541.

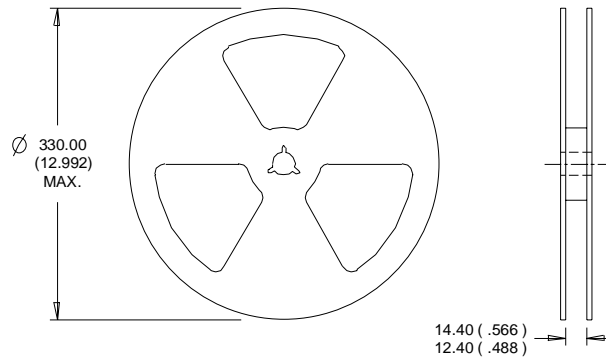

**NOTES:**

1. CONTROLLING DIMENSION : MILLIMETER.
2. OUTLINE CONFORMS TO EIA-481 & EIA-541.

Data and specifications subject to change without notice.

International  
**IR** Rectifier

**IR WORLD HEADQUARTERS:** 233 Kansas St., El Segundo, California 90245, USA Tel: (310) 252-7105

TAC Fax: (310) 252-7903

Visit us at [www.irf.com](http://www.irf.com) for sales contact information. 04/03