

NDS9958

Dual N & P-Channel Enhancement Mode Field Effect Transistor

General Description

These dual N- and P-Channel enhancement mode power field effect transistors are produced using Fairchild's proprietary, high cell density, DMOS technology. This very high density process is especially tailored to minimize on-state resistance, provide superior switching performance, and withstand high energy pulses in the avalanche and commutation modes. These devices are particularly suited for low voltage applications such as notebook computer power management, Half bridge motor control, cellular phone, and other battery powered circuits where fast switching, low in-line power loss, and resistance to transients are needed.

Features

- N-Channel 3.5A, 20V, $R_{DS(ON)} = 0.1\Omega @ V_{GS} = 10V$.
P-Channel -3.5A, -20V, $R_{DS(ON)} = 0.1\Omega @ V_{GS} = -10V$.
- High density cell design for extremely low $R_{DS(ON)}$.
- High power and current handling capability in a widely used surface mount package.
- Dual (N & P-Channel) MOSFET in surface mount package.

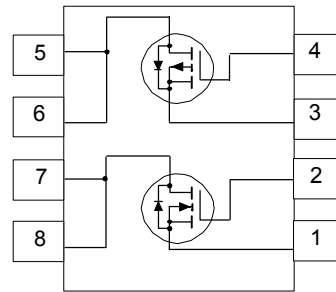
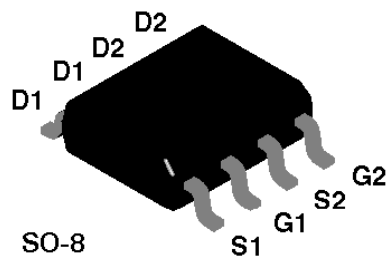

Absolute Maximum Ratings $T_A = 25^\circ\text{C}$ unless otherwise noted

Symbol	Parameter	N-Channel	P-Channel	Units
V_{DSS}	Drain-Source Voltage	20	-20	V
V_{GSS}	Gate-Source Voltage	± 20	± 20	V
I_D	Drain Current - Continuous $T_A = 25^\circ\text{C}$ (Note 1a)	± 3.5	± 3.5	A
	- Continuous $T_A = 70^\circ\text{C}$ (Note 1a)	± 2.8	± 2.8	
	- Pulsed $T_A = 25^\circ\text{C}$	± 14	± 14	
P_D	Power Dissipation for Dual Operation	2		W
	Power Dissipation for Single Operation (Note 1a)	1.6		
	(Note 1b)	1		
	(Note 1c)	0.9		
T_J, T_{STG}	Operating and Storage Temperature Range	-55 to 150		$^\circ\text{C}$

THERMAL CHARACTERISTICS

$R_{\theta JA}$	Thermal Resistance, Junction-to-Ambient (Note 1a)	78	$^\circ\text{C/W}$
$R_{\theta JC}$	Thermal Resistance, Junction-to-Case (Note 1)	40	$^\circ\text{C/W}$

Electrical Characteristics ($T_A = 25^\circ\text{C}$ unless otherwise noted)

Symbol	Parameter	Conditions	Type	Min	Typ	Max	Units	
OFF CHARACTERISTICS								
BV_{DS}	Drain-Source Breakdown Voltage	$V_{GS} = 0\text{ V}, I_D = 250\ \mu\text{A}$	N-Ch	20			V	
		$V_{GS} = 0\text{ V}, I_D = -250\ \mu\text{A}$	P-Ch	-20				
I_{DSS}	Zero Gate Voltage Drain Current	$V_{DS} = 16\text{ V}, V_{GS} = 0\text{ V}$	N-Ch			1	μA	
				$T_J = 70^\circ\text{C}$				5
		$V_{DS} = -16\text{ V}, V_{GS} = 0\text{ V}$	P-Ch			-1	μA	
				$T_J = 70^\circ\text{C}$				-5
I_{GSSF}	Gate - Body Leakage, Forward	$V_{GS} = 20\text{ V}, V_{DS} = 0\text{ V}$	All			100	nA	
I_{GSSR}	Gate - Body Leakage, Reverse	$V_{GS} = -20\text{ V}, V_{DS} = 0\text{ V}$	All			-100	nA	
ON CHARACTERISTICS (Note 2)								
$V_{GS(th)}$	Gate Threshold Voltage	$V_{DS} = V_{GS}, I_D = 250\ \mu\text{A}$	N-Ch		1	1.5	3	V
				$T_J = 125^\circ\text{C}$	0.7	1.1	2.2	
		$V_{DS} = V_{GS}, I_D = -250\ \mu\text{A}$	P-Ch		-1	-2.2	-3	
				$T_J = 125^\circ\text{C}$	-0.8	-1.9	-2.5	
$R_{DS(on)}$	Static Drain-Source On-Resistance	$V_{GS} = 10\text{ V}, I_D = 3.5\text{ A}$	N-Ch		0.062	0.1	Ω	
				$T_J = 125^\circ\text{C}$		0.085		0.14
		$V_{GS} = -10\text{ V}, I_D = -3.5\text{ A}$	P-Ch		0.08	0.1		
				$T_J = 125^\circ\text{C}$		0.11		0.16
		$V_{GS} = 6\text{ V}, I_D = 3.0\text{ A}$	N-Ch		0.073	0.12		
		$V_{GS} = -6\text{ V}, I_D = -3.0\text{ A}$	P-Ch		0.112	0.12		
		$V_{GS} = 4.5\text{ V}, I_D = 1.0\text{ A}$	N-Ch		0.08	0.15		
		$V_{GS} = -4.5\text{ V}, I_D = -1.0\text{ A}$	P-Ch		0.165	0.19		
$I_{D(on)}$	On-State Drain Current	$V_{GS} = 10\text{ V}, V_{DS} = 5\text{ V}$	N-Ch	14			A	
		$V_{GS} = -10\text{ V}, V_{DS} = -5\text{ V}$	P-Ch	-14				
		$V_{GS} = 4.5\text{ V}, V_{DS} = 5\text{ V}$	N-Ch	3.5				
		$V_{GS} = -4.5\text{ V}, V_{DS} = -5\text{ V}$	P-Ch	-2.5				
g_{FS}	Forward Transconductance	$V_{DS} = 15\text{ V}, I_D = 3.5\text{ A}$	N-Ch		7		S	
		$V_{DS} = -15\text{ V}, I_D = -3.5\text{ A}$	P-Ch		5			
DYNAMIC CHARACTERISTICS								
C_{iss}	Input Capacitance	N-Channel $V_{DS} = 10\text{ V}, V_{GS} = 0\text{ V},$ $f = 1.0\text{ MHz}$	N-Ch		525		pF	
			P-Ch		785			
C_{oss}	Output Capacitance		P-Channel $V_{DS} = -10\text{ V}, V_{GS} = 0\text{ V},$ $f = 1.0\text{ MHz}$	N-Ch		315		pF
				P-Ch		500		
C_{rss}	Reverse Transfer Capacitance			N-Ch		185		pF
				P-Ch		245		

Electrical Characteristics (T_A = 25°C unless otherwise noted)

Symbol	Parameter	Conditions	Type	Min	Typ	Max	Units
SWITCHING CHARACTERISTICS (Note 2)							
t _{D(on)}	Turn - On Delay Time	N-Channel V _{DD} = 10 V, I _D = 1 A, V _{GEN} = 10 V, R _{GEN} = 6 Ω	N-Ch		6	10	ns
			P-Ch		9	40	
t _r	Turn - On Rise Time	P-Channel V _{DD} = -10 V, I _D = -1 A, V _{GEN} = -10 V, R _{GEN} = 6 Ω	N-Ch		12	25	ns
			P-Ch		17	25	
t _{D(off)}	Turn - Off Delay Time		N-Ch		22	30	ns
				P-Ch		26	
t _f	Turn - Off Fall Time	N-Ch		8	20	ns	
			P-Ch		13		20
Q _g	Total Gate Charge	N-Channel V _{DS} = 10 V, I _b = 3.5 A, V _{GS} = 10 V	N-Ch		17	30	nC
			P-Ch		19	30	
Q _{gs}	Gate-Source Charge	P-Channel V _{DS} = -10 V, I _b = -3.5 A, V _{GS} = -10 V	N-Ch		1.2	6	nC
			P-Ch		3	6	
Q _{gd}	Gate-Drain Charge	N-Ch		5	12	nC	
			P-Ch		9		12

DRAIN-SOURCE DIODE CHARACTERISTICS AND MAXIMUM RATINGS

I _S	Maximum Continuous Drain-Source Diode Forward Current		N-Ch			1.7	A
			P-Ch			-1.7	
V _{SD}	Drain-Source Diode Forward Voltage	V _{GS} = 0 V, I _S = 1.7 A (Note 2)	N-Ch		0.86	1.2	V
		V _{GS} = 0 V, I _S = -1.7 A (Note 2)	P-Ch		-0.9	-1.2	
t _{rr}	Reverse Recovery Time	V _{GS} = 0V, I _F = 3.5 A, dI _F /dt = 100 A/μs	N-Ch			100	ns
			P-Ch			100	

Notes:

- R_{θJA} is the sum of the junction-to-case and case-to-ambient thermal resistance where the case thermal reference is defined as the solder mounting surface of the drain pins. R_{θJC} is guaranteed by design while R_{θCA} is determined by the user's board design.

$$P_D(t) = \frac{T_J - T_A}{R_{\theta J \theta A}} = \frac{T_J - T_A}{R_{\theta J \theta C} + R_{\theta C \theta A}} = I_D^2(t) \times R_{DS(on)} @ T_J$$

Typical R_{θJA} for single device operation using the board layouts shown below on 4.5"x5" FR-4 PCB in a still air environment:

- 78°C/W when mounted on a 0.5 in² pad of 2oz copper.
- 125°C/W when mounted on a 0.02 in² pad of 2oz copper.
- 135°C/W when mounted on a 0.003 in² pad of 2oz copper.

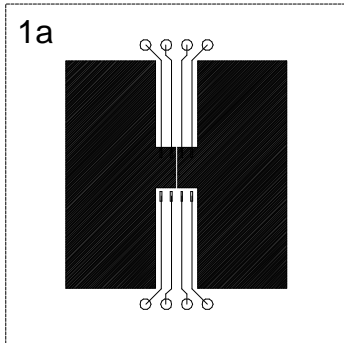

Scale 1 : 1 on letter size paper

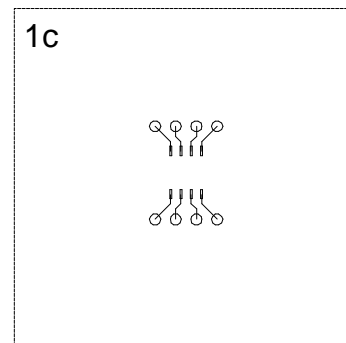
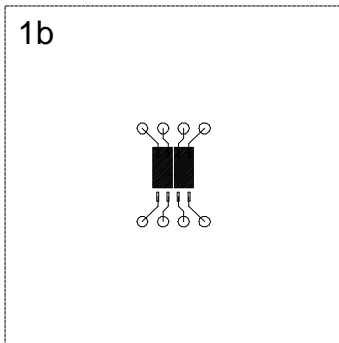

- Pulse Test: Pulse Width ≤ 300μs, Duty Cycle ≤ 2.0%.

Typical Electrical Characteristics: N-Channel

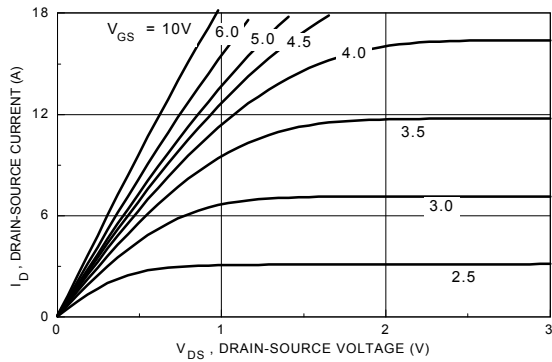

Figure 1. On-Region Characteristics.

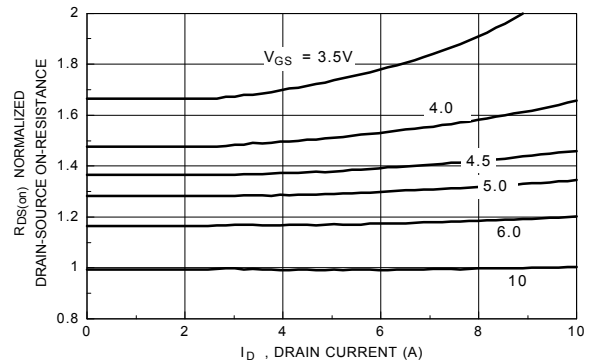

Figure 2. On-Resistance Variation with Gate Voltage and Drain Current.

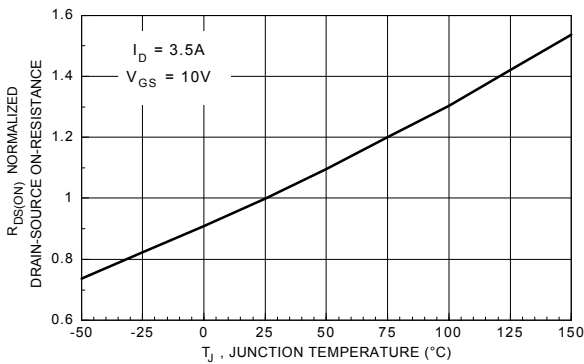

Figure 3. On-Resistance Variation with Temperature.

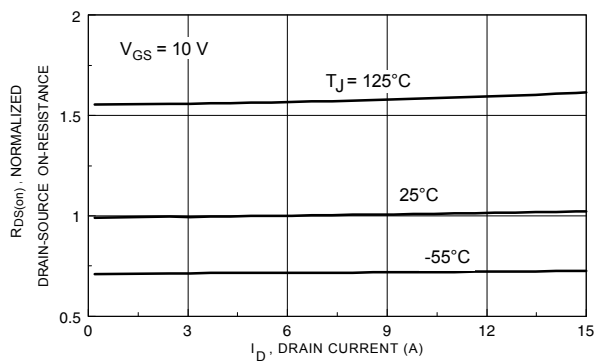

Figure 4. On-Resistance Variation with Drain Current and Temperature.

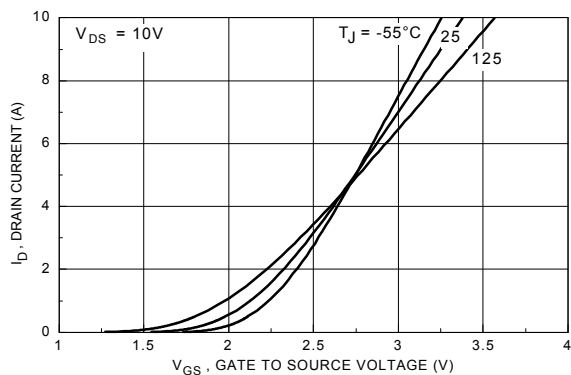

Figure 5. Transfer Characteristics.

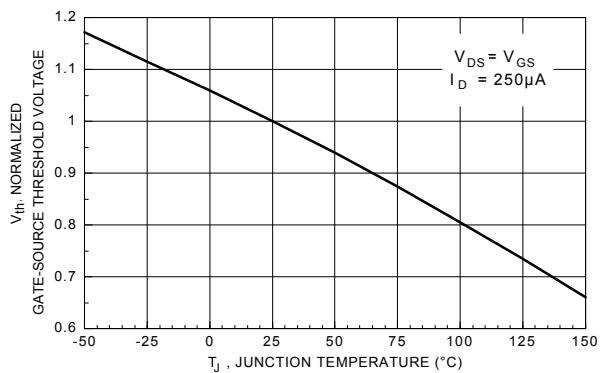

Figure 6. Gate Threshold Variation with Temperature.

Typical Electrical Characteristics: N-Channel (continued)

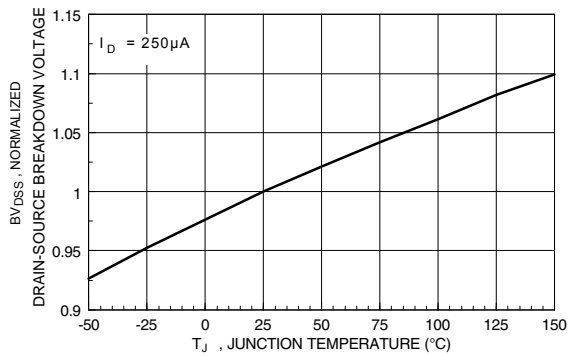

Figure 7. Breakdown Voltage Variation with Temperature.

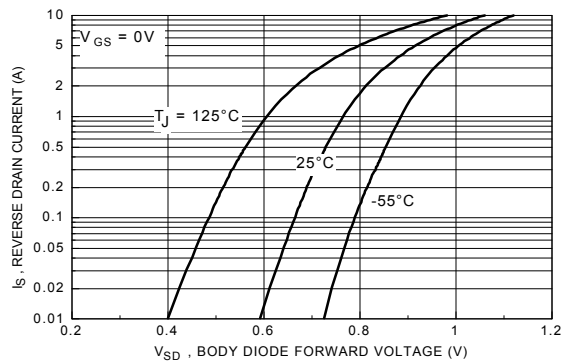

Figure 8. Body Diode Forward Voltage Variation with Current and Temperature

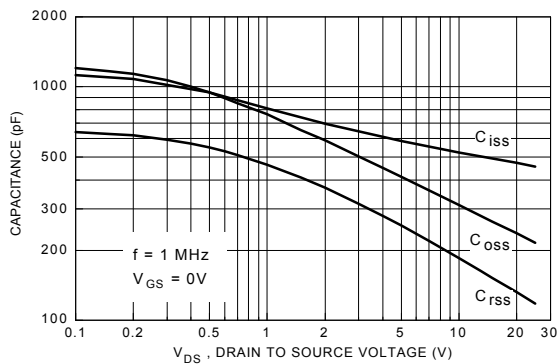

Figure 9. Capacitance Characteristics.

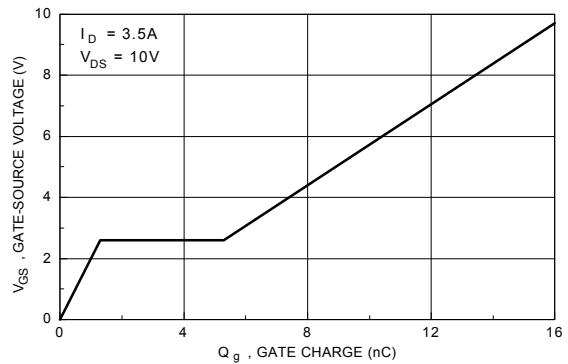

Figure 10. Gate Charge Characteristics.

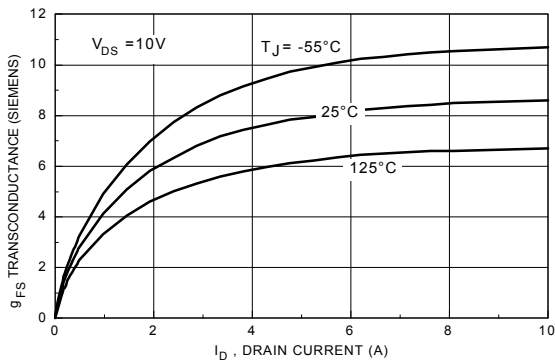

Figure 11. Transconductance Variation with Drain Current and Temperature.

Typical Electrical Characteristics: P-Channel

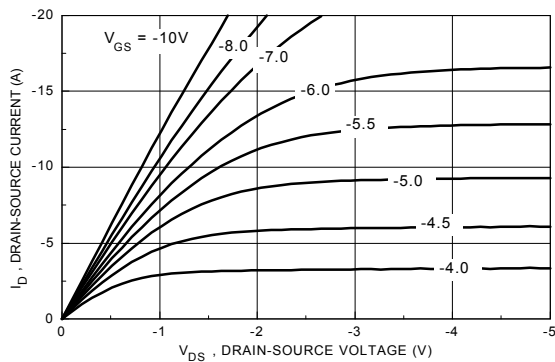

Figure 12. On-Region Characteristics.

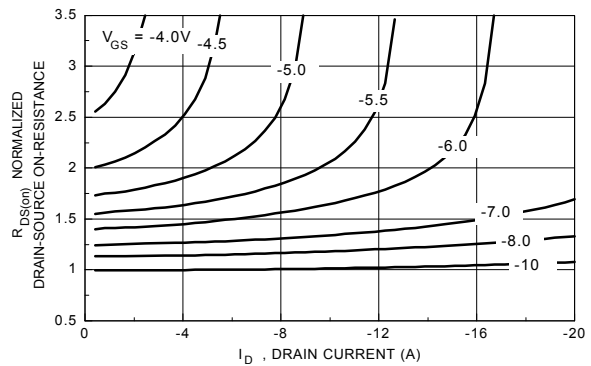

Figure 13. On-Resistance Variation with Gate Voltage and Drain Current.

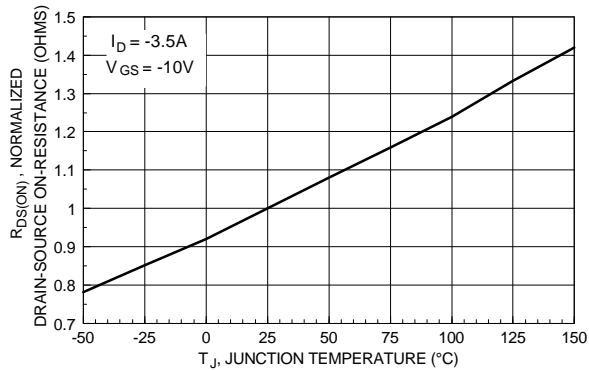

Figure 14. On-Resistance Variation with Temperature.

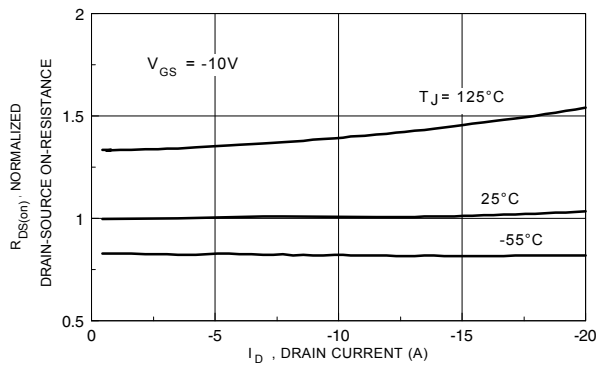

Figure 15. On-Resistance Variation with Drain Current and Temperature.

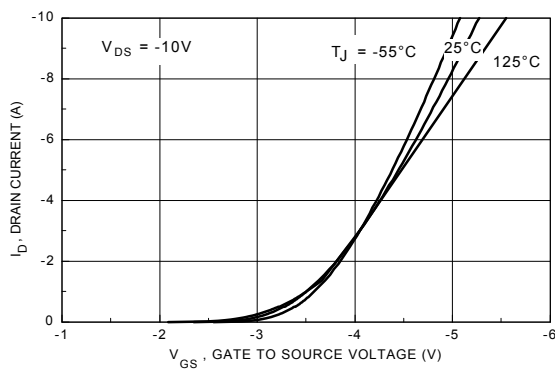

Figure 16. Drain Current Variation with Gate Voltage and Temperature.

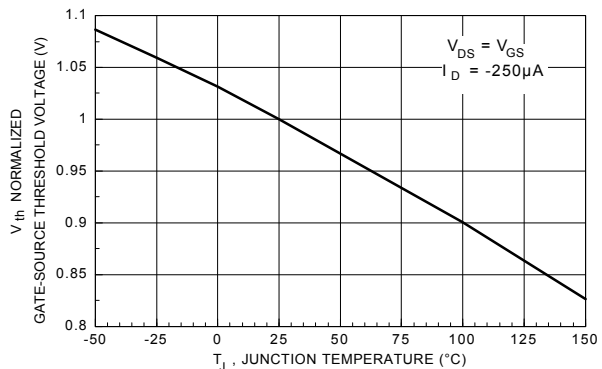

Figure 17. Gate Threshold Variation with Temperature.

Typical Electrical Characteristics: P-Channel (continued)

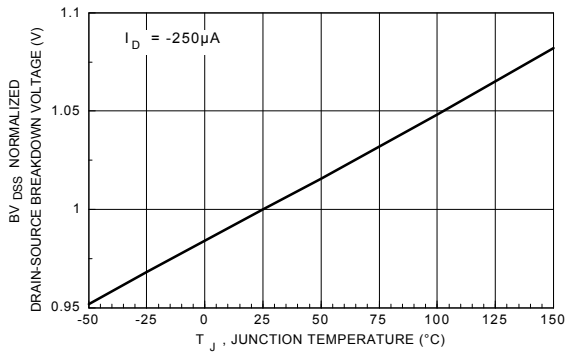

Figure 18. Breakdown Voltage Variation with Temperature.

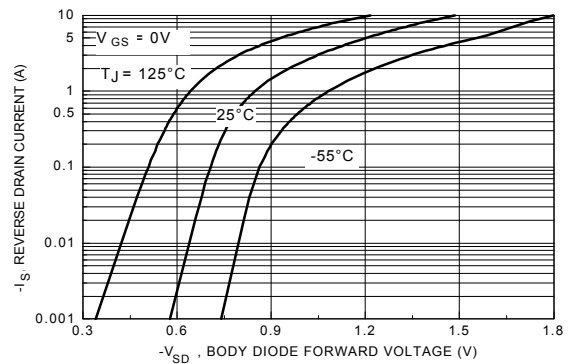

Figure 19. Body Diode Forward Voltage Variation with Current and Temperature

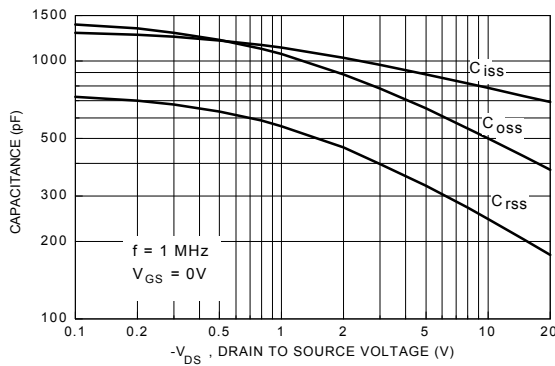

Figure 20. Capacitance Characteristics.

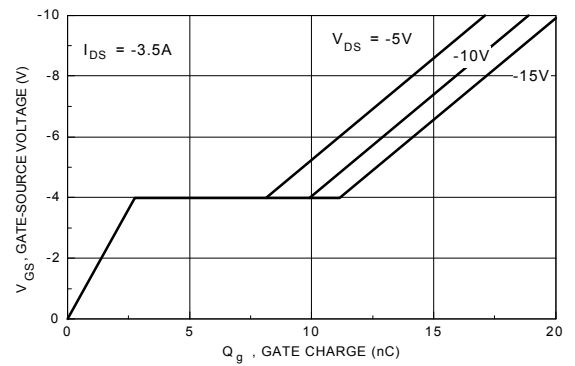

Figure 21. Gate Charge Characteristics

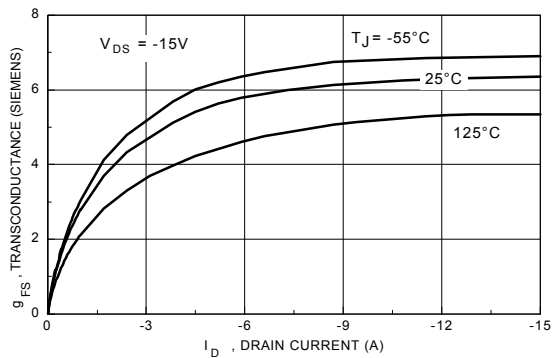

Figure 22. Transconductance Variation with Drain Current and Temperature.

Typical Electrical Characteristic: N & P-Channel (continued)

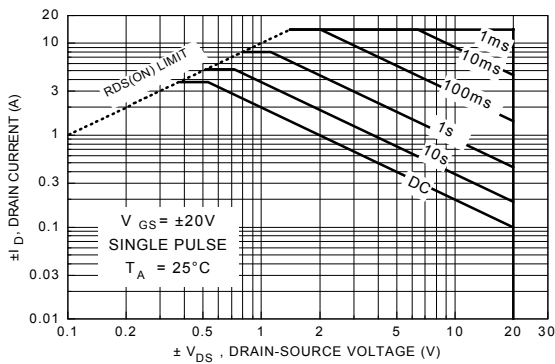

Figure 23. Maximum Safe Operating Area.

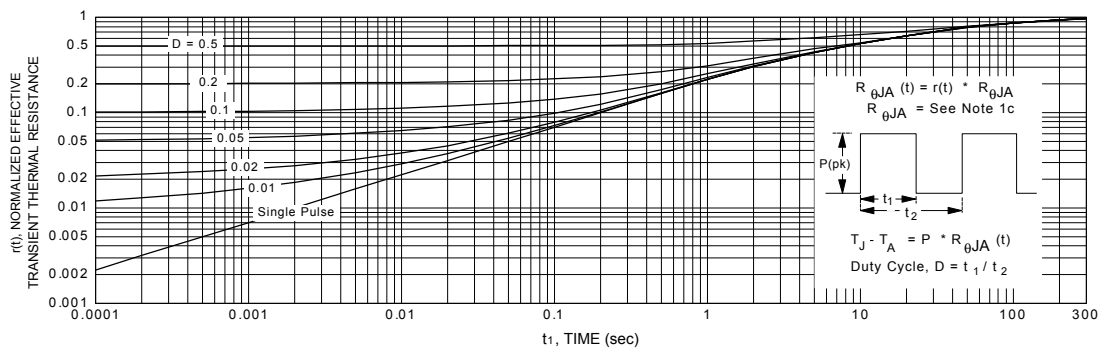

Figure 24. Transient Thermal Response Curve.

Note: Thermal characterization performed using the conditions described in note 1c. Transient thermal response will change depending on the circuit board design.

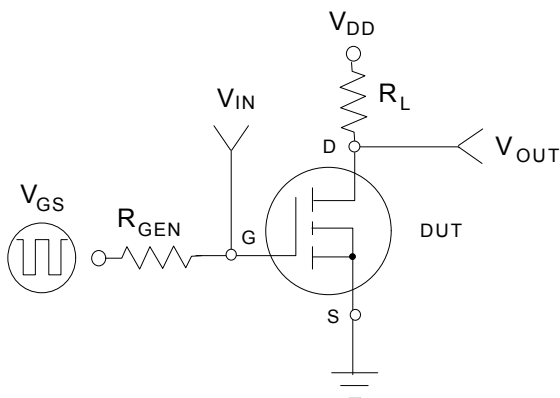

Figure 25. N or P-Channel Switching Test Circuit

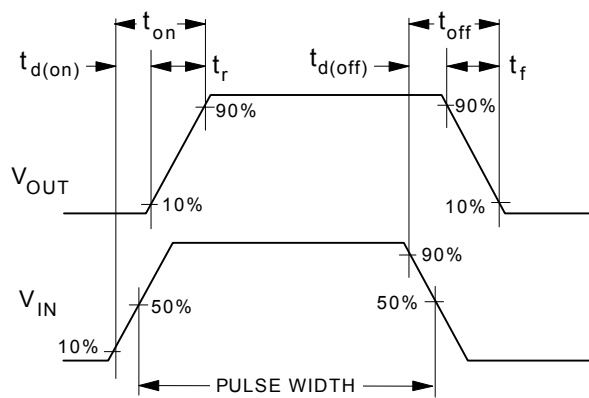
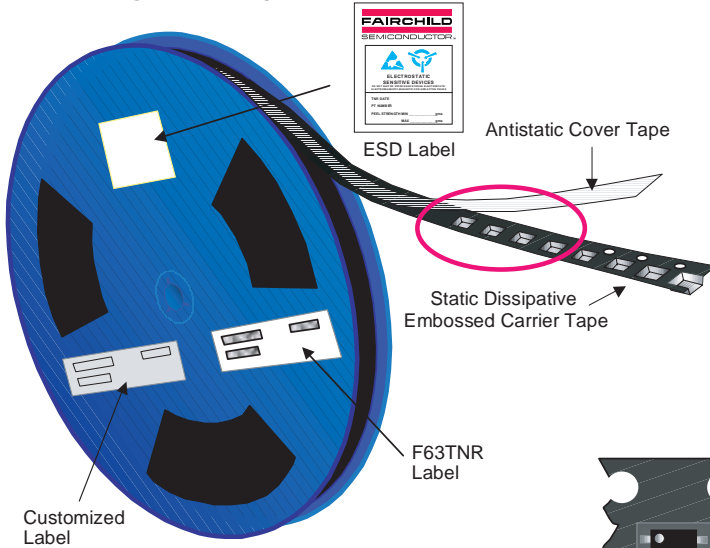

Figure 26. N or P-Channel Switching Waveforms

SO-8 Tape and Reel Data and Package Dimensions



SOIC(8lds) Packaging Configuration: Figure 1.0



Packaging Description:

SOIC-8 parts are shipped in tape. The carrier tape is made from a dissipative (carbon filled) polycarbonate resin. The cover tape is a multilayer film (Heat Activated Adhesive in nature) primarily composed of polyester film, adhesive layer, sealant, and anti-static sprayed agent. These reeled parts in standard option are shipped with 2,500 units per 13" or 330cm diameter reel. The reels are dark blue in color and is made of polystyrene plastic (anti-static coated). Other option comes in 500 units per 7" or 177cm diameter reel. This and some other options are further described in the Packaging Information table.

These full reels are individually barcode labeled and placed inside a standard intermediate box (illustrated in figure 1.0) made of recyclable corrugated brown paper. One box contains two reels maximum. And these boxes are placed inside a barcode labeled shipping box which comes in different sizes depending on the number of parts shipped.

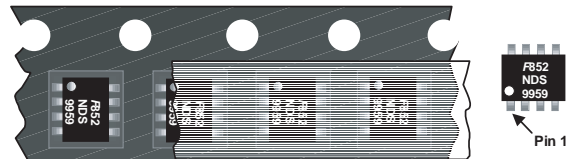

SOIC-8 Unit Orientation

SOIC (8lds) Packaging Information				
Packaging Option	Standard (no flow code)	L86Z	F011	D84Z
Packaging type	TNR	Rail/Tube	TNR	TNR
Qty per Reel/Tube/Bag	2,500	95	4,000	500
Reel Size	13" Dia	-	13" Dia	7" Dia
Box Dimension (mm)	343x64x343	530x130x83	343x64x343	184x187x47
Max qty per Box	5,000	30,000	8,000	1,000
Weight per unit (gm)	0.0774	0.0774	0.0774	0.0774
Weight per Reel (kg)	0.6060	-	0.9696	0.1182
Note/Comments				

F63TNR Label sample

LOT: CBVK741B019 QTY: 2500
 FSID: FDS9853A SPEC:
 D/C1: D9842 QTY1: SPEC REV:
 D/C2: QTY2: CPN:
 N/F: F (F63TNR)3

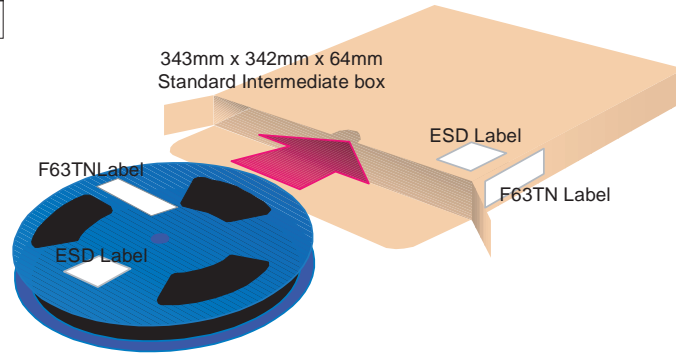

SOIC(8lds) Tape Leader and Trailer Configuration: Figure 2.0

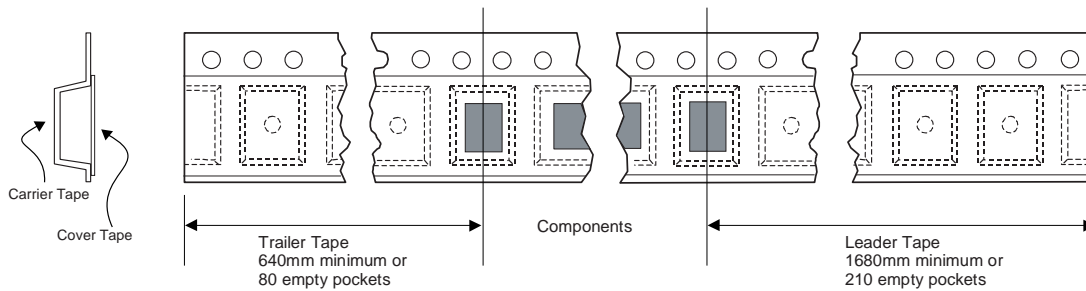

SO-8 Tape and Reel Data and Package Dimensions, continued

SOIC(8lds) Embossed Carrier Tape Configuration: Figure 3.0

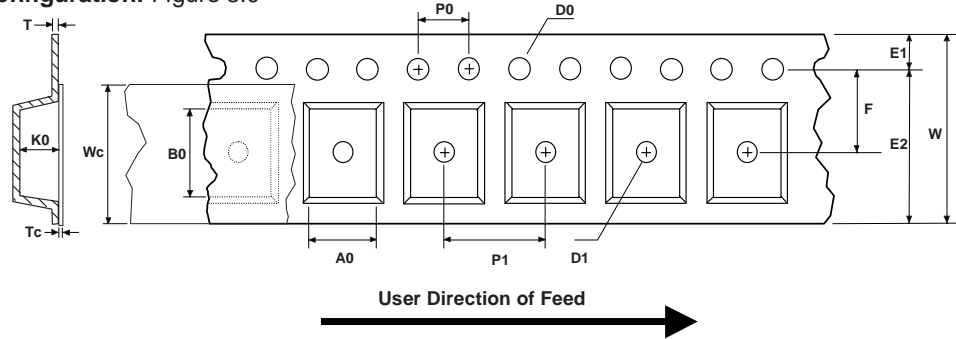

Dimensions are in millimeter														
Pkg type	A0	B0	W	D0	D1	E1	E2	F	P1	P0	K0	T	Wc	Tc
SOIC(8lds) (12mm)	6.50 +/-0.10	5.30 +/-0.10	12.0 +/-0.3	1.55 +/-0.05	1.60 +/-0.10	1.75 +/-0.10	10.25 min	5.50 +/-0.05	8.0 +/-0.1	4.0 +/-0.1	2.1 +/-0.10	0.450 +/- 0.150	9.2 +/-0.3	0.06 +/-0.02

Notes: A0, B0, and K0 dimensions are determined with respect to the EIA/Jedec RS-481 rotational and lateral movement requirements (see sketches A, B, and C).

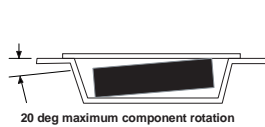

Sketch A (Side or Front Sectional View)
Component Rotation

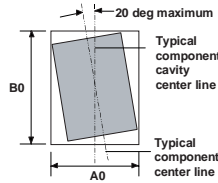

Sketch B (Top View)
Component Rotation

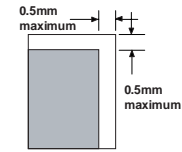

Sketch C (Top View)
Component lateral movement

SOIC(8lds) Reel Configuration: Figure 4.0

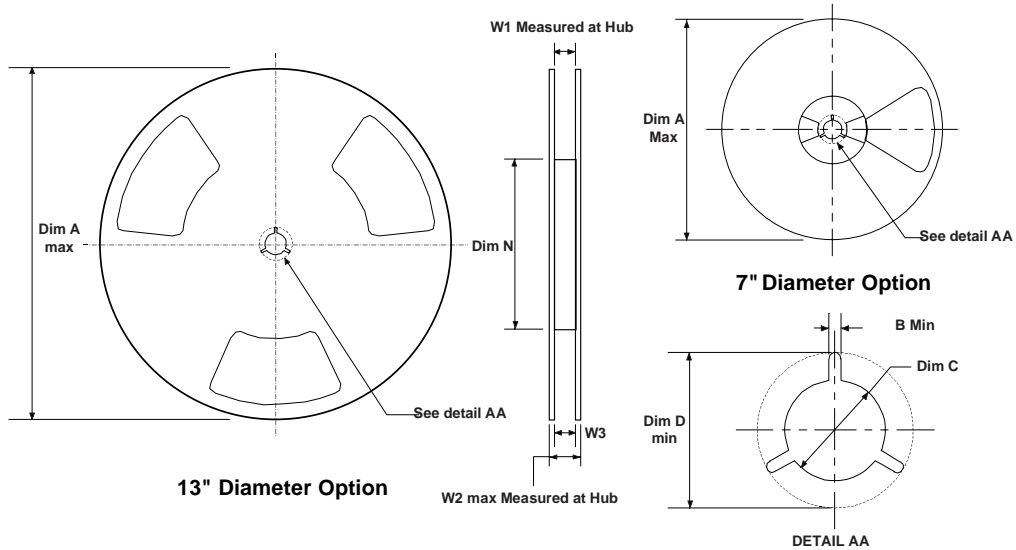

Dimensions are in inches and millimeters									
Tape Size	Reel Option	Dim A	Dim B	Dim C	Dim D	Dim N	Dim W1	Dim W2	Dim W3 (LSL-USL)
12mm	7" Dia	7.00 177.8	0.059 1.5	512 +0.020/-0.008 13 +0.5/-0.2	0.795 20.2	2.165 55	0.488 +0.078/-0.000 12.4 +2/0	0.724 18.4	0.469 - 0.606 11.9 - 15.4
12mm	13" Dia	13.00 330	0.059 1.5	512 +0.020/-0.008 13 +0.5/-0.2	0.795 20.2	7.00 178	0.488 +0.078/-0.000 12.4 +2/0	0.724 18.4	0.469 - 0.606 11.9 - 15.4

July 1999, Rev. B

SO-8 Tape and Reel Data and Package Dimensions, continued

SOIC-8 (FS PKG Code S1)

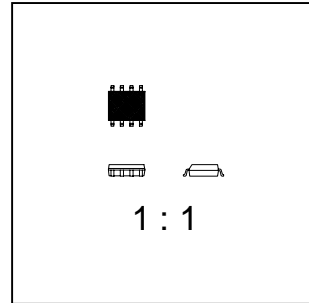
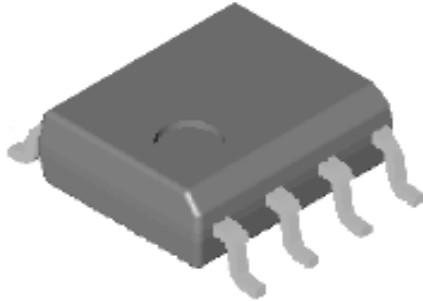

Scale 1:1 on letter size paper

Dimensions shown below are in:
inches [millimeters]

Part Weight per unit (gram): 0.0774

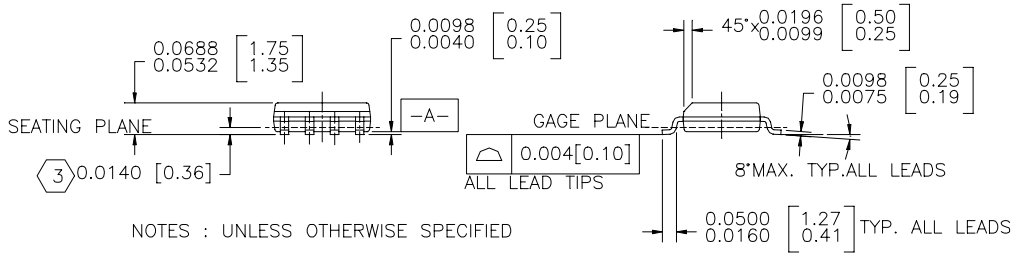
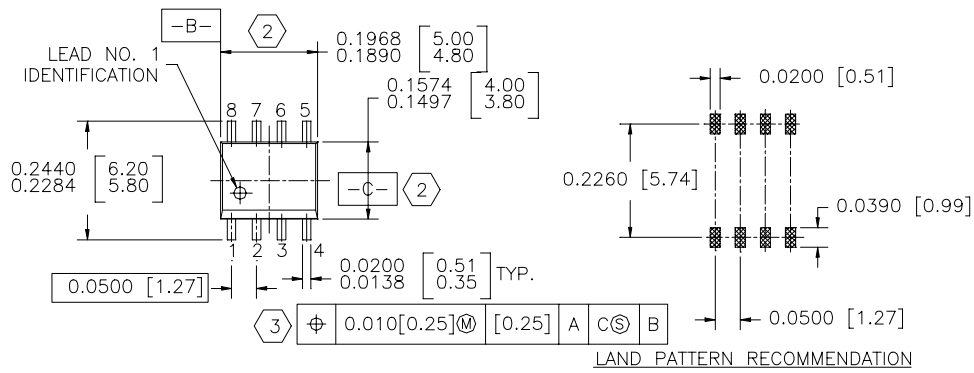

NOTES : UNLESS OTHERWISE SPECIFIED

1. STANDARD LEAD FINISH:
200 MICROINCHES / 5.08 MICRONS MINIMUM
LEAD / TIN (SOLDER) ON COPPER.

SO 0.150 WIDE 8 LEADS

2. THESE DIMENSIONS DO NOT INCLUDE MOLD FLASH

3. MAXIMUM LEAD 0.024 [0.609]

TRADEMARKS

The following are registered and unregistered trademarks Fairchild Semiconductor owns or is authorized to use and is not intended to be an exhaustive list of all such trademarks.

ACEx™	HiSeC™	SuperSOT™-8
Bottomless™	ISOPLANAR™	SyncFET™
CoolFET™	MICROWIRE™	TinyLogic™
CROSSVOLT™	POP™	UHC™
E ² CMOS™	PowerTrench®	VCX™
FACT™	QFET™	
FACT Quiet Series™	QS™	
FAST®	Quiet Series™	
FASTr™	SuperSOT™-3	
GTO™	SuperSOT™-6	

DISCLAIMER

FAIRCHILD SEMICONDUCTOR RESERVES THE RIGHT TO MAKE CHANGES WITHOUT FURTHER NOTICE TO ANY PRODUCTS HEREIN TO IMPROVE RELIABILITY, FUNCTION OR DESIGN. FAIRCHILD DOES NOT ASSUME ANY LIABILITY ARISING OUT OF THE APPLICATION OR USE OF ANY PRODUCT OR CIRCUIT DESCRIBED HEREIN; NEITHER DOES IT CONVEY ANY LICENSE UNDER ITS PATENT RIGHTS, NOR THE RIGHTS OF OTHERS.

LIFE SUPPORT POLICY

FAIRCHILD'S PRODUCTS ARE NOT AUTHORIZED FOR USE AS CRITICAL COMPONENTS IN LIFE SUPPORT DEVICES OR SYSTEMS WITHOUT THE EXPRESS WRITTEN APPROVAL OF FAIRCHILD SEMICONDUCTOR CORPORATION. As used herein:

1. Life support devices or systems are devices or systems which, (a) are intended for surgical implant into the body, or (b) support or sustain life, or (c) whose failure to perform when properly used in accordance with instructions for use provided in the labeling, can be reasonably expected to result in significant injury to the user.
2. A critical component is any component of a life support device or system whose failure to perform can be reasonably expected to cause the failure of the life support device or system, or to affect its safety or effectiveness.

PRODUCT STATUS DEFINITIONS

Definition of Terms

Datasheet Identification	Product Status	Definition
Advance Information	Formative or In Design	This datasheet contains the design specifications for product development. Specifications may change in any manner without notice.
Preliminary	First Production	This datasheet contains preliminary data, and supplementary data will be published at a later date. Fairchild Semiconductor reserves the right to make changes at any time without notice in order to improve design.
No Identification Needed	Full Production	This datasheet contains final specifications. Fairchild Semiconductor reserves the right to make changes at any time without notice in order to improve design.
Obsolete	Not In Production	This datasheet contains specifications on a product that has been discontinued by Fairchild semiconductor. The datasheet is printed for reference information only.