

# NTUD3170NZ

## Small Signal MOSFET

20 V, 220 mA, Dual N-Channel, 1.0 mm x 1.0 mm SOT-963 Package

### Features

- Dual N-Channel MOSFET
- Offers a Low  $R_{DS(ON)}$  Solution in the Ultra Small 1.0 x 1.0 mm Package
- 1.5 V Gate Voltage Rating
- Ultra Thin Profile (< 0.5 mm) Allows It to Fit Easily into Extremely Thin Environments such as Portable Electronics
- This is a Pb-Free Device

### Applications

- General Purpose Interfacing Switch
- Optimized for Power Management in Ultra Portable Equipment
- Analog Switch

### MAXIMUM RATINGS ( $T_J = 25^\circ\text{C}$ unless otherwise specified)

Parameter		Symbol	Value	Unit
Drain-to-Source Voltage		$V_{DSS}$	20	V
Gate-to-Source Voltage		$V_{GS}$	$\pm 8$	V
Continuous Drain Current (Note 1)	Steady State	$T_A = 25^\circ\text{C}$	220	mA
			$T_A = 85^\circ\text{C}$	
	$t \leq 5 \text{ s}$	$T_A = 25^\circ\text{C}$	280	
Power Dissipation (Note 1)	Steady State	$T_A = 25^\circ\text{C}$	125	mW
	$t \leq 5 \text{ s}$		200	
Pulsed Drain Current		$t_p = 10 \mu\text{s}$	$I_{DM}$	800 mA
Operating Junction and Storage Temperature		$T_J, T_{STG}$	-55 to 150	$^\circ\text{C}$
Source Current (Body Diode) (Note 2)		$I_S$	200	mA
Lead Temperature for Soldering Purposes (1/8" from case for 10 s)		$T_L$	260	$^\circ\text{C}$

Stresses exceeding Maximum Ratings may damage the device. Maximum Ratings are stress ratings only. Functional operation above the Recommended Operating Conditions is not implied. Extended exposure to stresses above the Recommended Operating Conditions may affect device reliability.

1. Surface-mounted on FR4 board using the minimum recommended pad size, 1 oz Cu.
2. Pulse Test: pulse width  $\leq 300 \mu\text{s}$ , duty cycle  $\leq 2\%$



ON Semiconductor®

<http://onsemi.com>

$V_{(BR)DSS}$	$R_{DS(ON)} \text{ MAX}$	$I_D \text{ Max}$
20 V	1.5 $\Omega$ @ 4.5 V	0.22 A
	2.0 $\Omega$ @ 2.5 V	
	3.0 $\Omega$ @ 1.8 V	
	4.5 $\Omega$ @ 1.5 V	

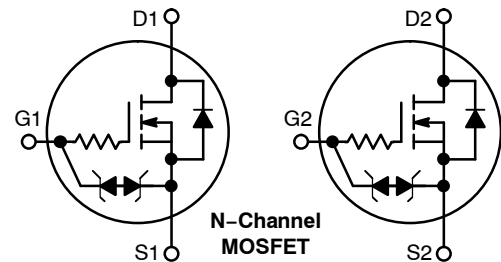

### PINOUT: SOT-963

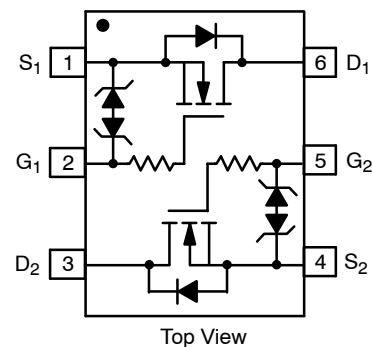

### MARKING DIAGRAM



SOT-963  
CASE 527AD

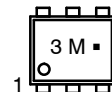

- 3 = Specific Device Code
- M = Date Code
- = Pb-Free Package

### ORDERING INFORMATION

See detailed ordering and shipping information in the package dimensions section on page 2 of this data sheet.

# NTUD3170NZ

## THERMAL RESISTANCE RATINGS

Parameter	Symbol	Max	Unit
Junction-to-Ambient – Steady State (Note 3)	$R_{\theta JA}$	1000	°C/W
Junction-to-Ambient – $t = 5$ s (Note 3)		600	

3. Surface-mounted on FR4 board using the minimum recommended pad size, 1 oz Cu.

## ELECTRICAL CHARACTERISTICS ( $T_J = 25^\circ\text{C}$ unless otherwise specified)

Parameter	Symbol	Test Condition	Min	Typ	Max	Unit
<b>OFF CHARACTERISTICS</b>						
Drain-to-Source Breakdown Voltage	$V_{(BR)DSS}$	$V_{GS} = 0$ V, $I_D = 250$ $\mu$ A	20			V
Zero Gate Voltage Drain Current	$I_{DSS}$	$V_{GS} = 0$ V, $V_{DS} = 5$ V	$T_J = 25^\circ\text{C}$		50	nA
			$T_J = 85^\circ\text{C}$		200	nA
		$V_{GS} = 0$ V, $V_{DS} = 16$ V	$T_J = 25^\circ\text{C}$		100	nA
Gate-to-Source Leakage Current	$I_{GSS}$	$V_{DS} = 0$ V, $V_{GS} = \pm 5.0$ V			$\pm 100$	nA

## ON CHARACTERISTICS (Note 4)

Gate Threshold Voltage	$V_{GS(TH)}$	$V_{GS} = V_{DS}$ , $I_D = 250$ $\mu$ A	0.4		1.0	V
Drain-to-Source On Resistance	$R_{DS(ON)}$	$V_{GS} = 4.5$ V, $I_D = 100$ mA		0.75	1.5	$\Omega$
		$V_{GS} = 2.5$ V, $I_D = 50$ mA		1.0	2.0	
		$V_{GS} = 1.8$ V, $I_D = 20$ mA		1.4	3.0	
		$V_{GS} = 1.5$ V, $I_D = 10$ mA		1.8	4.5	
		$V_{GS} = 1.2$ V, $I_D = 1.0$ mA		2.8		
Forward Transconductance	$g_{FS}$	$V_{DS} = 5.0$ V, $I_D = 125$ mA		0.48		S
Source-Drain Diode Voltage	$V_{SD}$	$V_{GS} = 0$ V, $I_S = 10$ mA		0.6	1.0	V

## CAPACITANCES

Input Capacitance	$C_{ISS}$	$f = 1.0$ MHz, $V_{GS} = 0$ V $V_{DS} = 15$ V		12.5		pF
Output Capacitance	$C_{OSS}$			3.6		
Reverse Transfer Capacitance	$C_{RSS}$			2.6		

## SWITCHING CHARACTERISTICS, $V_{GS} = 4.5$ V (Note 4)

Turn-On Delay Time	$t_{d(ON)}$	$V_{GS} = 4.5$ V, $V_{DD} = 10$ V, $I_D = 200$ mA, $R_G = 2.0$ $\Omega$		16.5		ns
Rise Time	$t_r$			25.5		
Turn-Off Delay Time	$t_{d(OFF)}$			142		
Fall Time	$t_f$			80		

4. Switching characteristics are independent of operating junction temperatures.

## ORDERING INFORMATION

Device	Package	Shipping <sup>†</sup>
NTUD3170NZT5G	SOT-963 (Pb-Free)	8000 / Tape & Reel

<sup>†</sup>For information on tape and reel specifications, including part orientation and tape sizes, please refer to our Tape and Reel Packaging Specifications Brochure, BRD8011/D.

TYPICAL CHARACTERISTICS

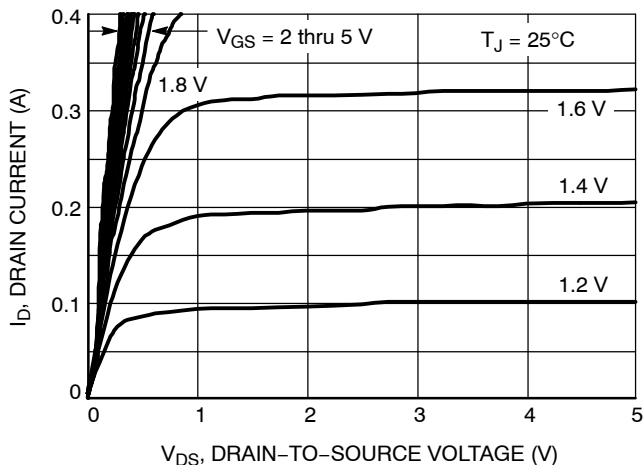

Figure 1. On-Region Characteristics

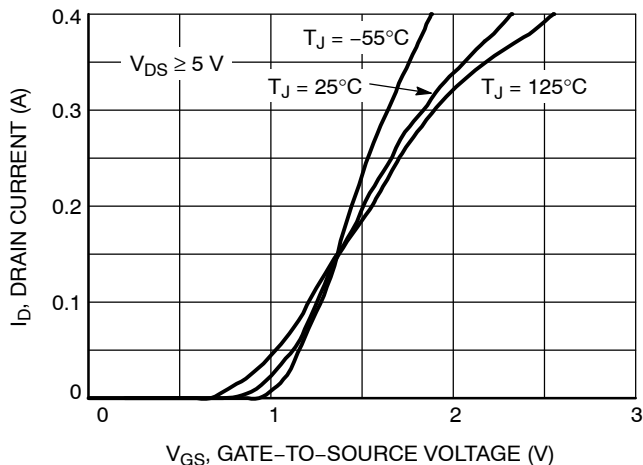

Figure 2. Transfer Characteristics

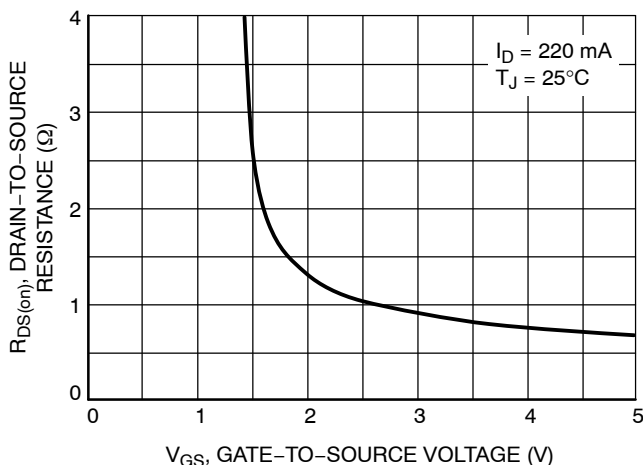

Figure 3. On-Resistance vs. Gate Voltage

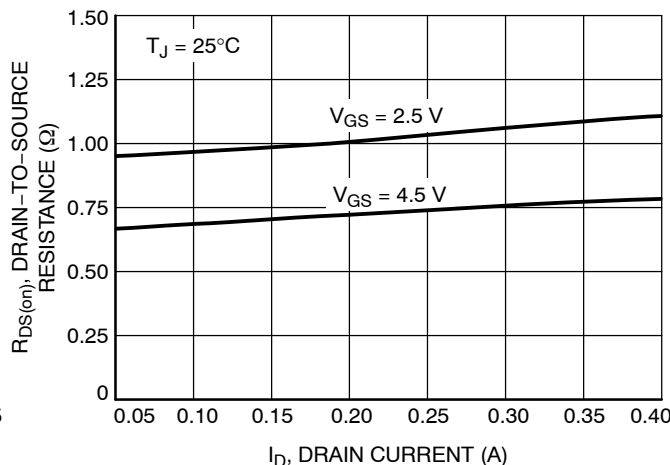

Figure 4. On-Resistance vs. Drain Current and Gate Voltage

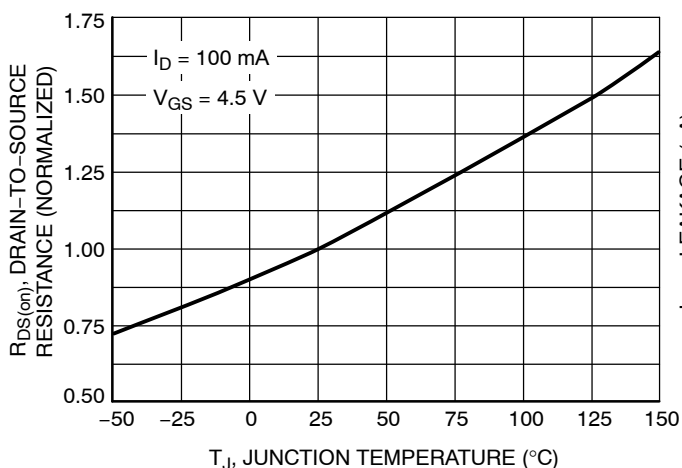

Figure 5. On-Resistance Variation with Temperature

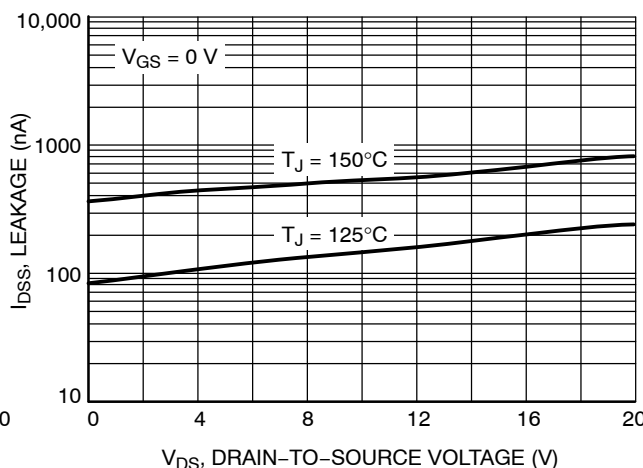

Figure 6. Drain-to-Source Leakage Current vs. Voltage

# NTUD3170NZ

## TYPICAL CHARACTERISTICS

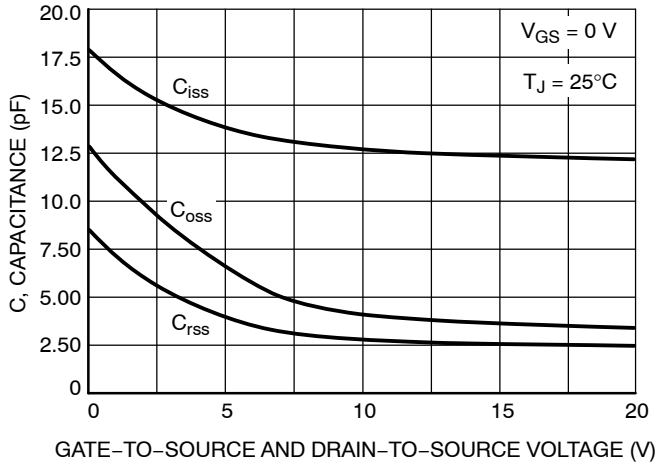

Figure 7. Capacitance Variation

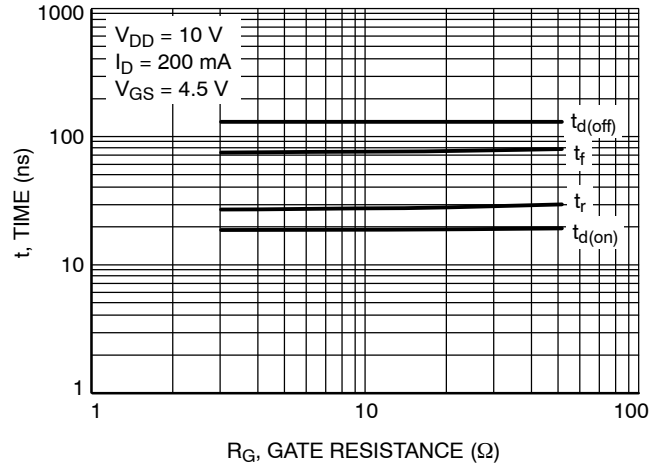

Figure 8. Resistive Switching Time Variation vs. Gate Resistance

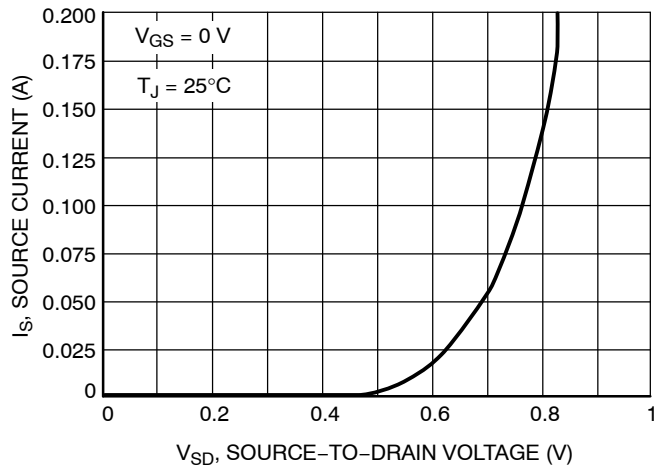
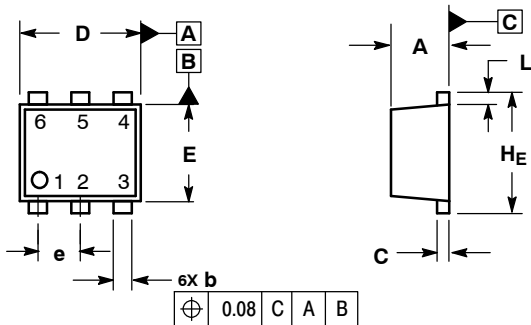

Figure 9. Diode Forward Voltage vs. Current

# NTUD3170NZ

## PACKAGE DIMENSIONS

SOT-963  
CASE 527AD-01  
ISSUE D



### NOTES:

1. DIMENSIONING AND TOLERANCING PER ANSI Y14.5M, 1982.
2. CONTROLLING DIMENSION: MILLIMETERS
3. MAXIMUM LEAD THICKNESS INCLUDES LEAD FINISH THICKNESS. MINIMUM LEAD THICKNESS IS THE MINIMUM THICKNESS OF BASE MATERIAL.

DIM	MILLIMETERS			INCHES		
	MIN	NOM	MAX	MIN	NOM	MAX
A	0.34	0.37	0.40			
b	0.10	0.15	0.20	0.004	0.006	0.008
C	0.07	0.12	0.17	0.003	0.005	0.007
D	0.95	1.00	1.05	0.037	0.039	0.041
E	0.75	0.80	0.85	0.03	0.032	0.034
e	0.35 BSC			0.014 BSC		
L	0.05	0.10	0.15	0.002	0.004	0.006
HE	0.95	1.00	1.05	0.037	0.039	0.041

### SOLDERING FOOTPRINT\*

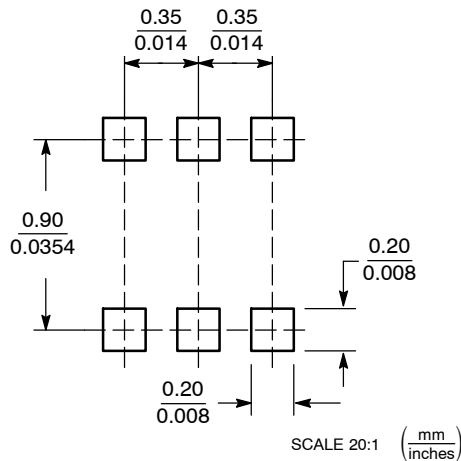

\*For additional information on our Pb-Free strategy and soldering details, please download the ON Semiconductor Soldering and Mounting Techniques Reference Manual, SOLDERRM/D.

ON Semiconductor and are registered trademarks of Semiconductor Components Industries, LLC (SCILLC). SCILLC reserves the right to make changes without further notice to any products herein. SCILLC makes no warranty, representation or guarantee regarding the suitability of its products for any particular purpose, nor does SCILLC assume any liability arising out of the application or use of any product or circuit, and specifically disclaims any and all liability, including without limitation special, consequential or incidental damages. "Typical" parameters which may be provided in SCILLC data sheets and/or specifications can and do vary in different applications and actual performance may vary over time. All operating parameters, including "Typicals" must be validated for each customer application by customer's technical experts. SCILLC does not convey any license under its patent rights nor the rights of others. SCILLC products are not designed, intended, or authorized for use as components in systems intended for surgical implant into the body, or other applications intended to support or sustain life, or for any other application in which the failure of the SCILLC product could create a situation where personal injury or death may occur. Should Buyer purchase or use SCILLC products for any such unintended or unauthorized application, Buyer shall indemnify and hold SCILLC and its officers, employees, subsidiaries, affiliates, and distributors harmless against all claims, costs, damages, and expenses, and reasonable attorney fees arising out of, directly or indirectly, any claim of personal injury or death associated with such unintended or unauthorized use, even if such claim alleges that SCILLC was negligent regarding the design or manufacture of the part. SCILLC is an Equal Opportunity/Affirmative Action Employer. This literature is subject to all applicable copyright laws and is not for resale in any manner.

### PUBLICATION ORDERING INFORMATION

**LITERATURE FULFILLMENT:**  
Literature Distribution Center for ON Semiconductor  
P.O. Box 5163, Denver, Colorado 80217 USA  
**Phone:** 303-675-2175 or 800-344-3860 Toll Free USA/Canada  
**Fax:** 303-675-2176 or 800-344-3867 Toll Free USA/Canada  
**Email:** orderlit@onsemi.com

**N. American Technical Support:** 800-282-9855 Toll Free  
USA/Canada  
**Europe, Middle East and Africa Technical Support:**  
Phone: 421 33 790 2910  
**Japan Customer Focus Center**  
Phone: 81-3-5773-3850

**ON Semiconductor Website:** [www.onsemi.com](http://www.onsemi.com)  
**Order Literature:** <http://www.onsemi.com/orderlit>  
For additional information, please contact your local Sales Representative

NTUD3170NZ/D