

TrenchT2™ HiperFET N-Channel Power MOSFET

FMM110-015X2F

$$V_{DSS} = 150V$$

$$I_{D25} = 53A$$

$$R_{DS(on)} \leq 20m\Omega$$

$$t_{rr(typ)} = 85ns$$

Phase Leg Topology

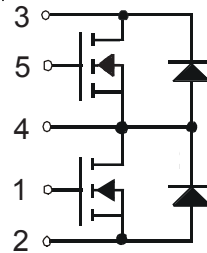

ISOPLUS i4-Pak™

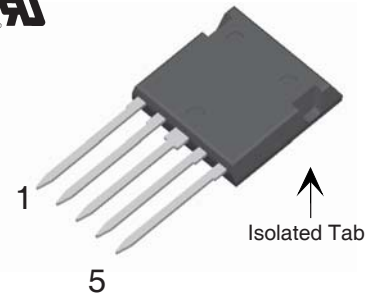

Symbol	Test Conditions	Maximum Ratings	
T_J		-55 ... +175	°C
T_{JM}		175	°C
T_{stg}		-55 ... +175	°C
V_{ISOLD}	50/60Hz, RMS, t = 1min, Leads-to-Tab	2500	~V
T_L	1.6mm (0.062 in.) from Case for 10s	300	°C
T_{SOLD}	Plastic Body for 10s	260	°C
F_C	Mounting Force	20..120 / 4.5..27	N/lb.

Symbol	Test Conditions	Maximum Ratings	
V_{DSS}	$T_J = 25^\circ C$ to $175^\circ C$	150	V
V_{DGR}	$T_J = 25^\circ C$ to $175^\circ C$, $R_{GS} = 1M\Omega$	150	V
V_{GSM}	Transient	± 30	V
I_{D25}	$T_C = 25^\circ C$	53	A
I_{DM}	$T_C = 25^\circ C$, Pulse Width Limited by T_{JM}	300	A
I_A	$T_C = 25^\circ C$	55	A
E_{AS}	$T_C = 25^\circ C$	800	mJ
dV/dt	$I_S \leq I_{DM}$, $V_{DD} \leq V_{DSS}$, $T_J \leq 175^\circ C$	10	V/ns
P_D	$T_C = 25^\circ C$	180	W

Features

- Silicon Chip on Direct-Copper Bond (DCB) Substrate
 - UL Recognized Package
 - Isolated Mounting Surface
 - 2500V Electrical Isolation
- Avalanche Rated
- Low Q_G
- Low Drain-to-Tab Capacitance
- Low Package Inductance

Advantages

- Easy to Mount
- Space Savings
- High Power Density

Applications

- DC-DC Converters
- Battery Chargers
- Switched-Mode and Resonant-Mode Power Supplies
- DC Choppers
- AC Motor Drives
- Uninterruptible Power Supplies
- High Speed Power Switching Applications

Symbol	Test Conditions	Characteristic Values		
		Min.	Typ.	Max.
C_p	Coupling Capacitance Between Shorted Pins and Mounting Tab in the Case		40	pF
d_S, d_A	Pin - Pin	1.7		mm
d_S, d_A	Pin - Backside Metal	5.5		mm
Weight			9	g

Symbol	Test Conditions ² ($T_J = 25^\circ\text{C}$ Unless Otherwise Specified)	Characteristic Values		
		Min.	Typ.	Max.
BV_{DSS}	$V_{GS} = 0V, I_D = 250\mu\text{A}$	150		V
$V_{GS(th)}$	$V_{DS} = V_{GS}, I_D = 250\mu\text{A}$	2.5		4.5 V
I_{GSS}	$V_{GS} = \pm 20V, V_{DS} = 0V$			± 200 nA
I_{DSS}	$V_{DS} = V_{DSS}, V_{GS} = 0V$ $T_J = 150^\circ\text{C}$			2 μA 500 μA
$R_{DS(on)}$	$V_{GS} = 10V, I_D = 55A, \text{Note 1}$			20 m Ω
g_{fs}	$V_{DS} = 10V, I_D = 55A, \text{Note 1}$	75	115	S
C_{iss}	$V_{GS} = 0V, V_{DS} = 25V, f = 1\text{MHz}$		8600	pF
C_{oss}				
C_{rss}				
$t_{d(on)}$	Resistive Switching Times $V_{GS} = 10V, V_{DS} = 0.5 \cdot V_{DSS}, I_D = 55A$ $R_G = 3.3\Omega$ (External)		33	ns
t_r				
$t_{d(off)}$				
t_f				
$Q_{g(on)}$	$V_{GS} = 10V, V_{DS} = 0.5 \cdot V_{DSS}, I_D = 55A$		150	nC
Q_{gs}				
Q_{gd}				
R_{thJC}				0.83 $^\circ\text{C/W}$
R_{thCS}		0.15		$^\circ\text{C/W}$

ISOPLUS i4-Pak™ Outline

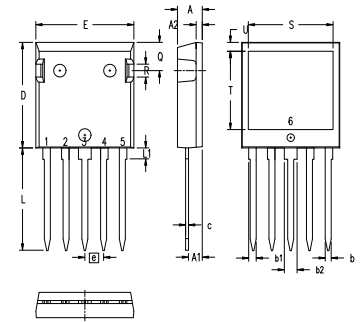

NOTE: Bottom heatsink meets 3000 Volts AC 1 sec isolation to the other pins.

SYM	INCHES		MILLIMETERS	
	MIN	MAX	MIN	MAX
A	.190	.205	4.83	5.21
A1	.102	.118	2.59	3.00
A2	.046	.085	1.17	2.16
b	.045	.055	1.14	1.40
b1	.058	.068	1.47	1.73
b2	.100	.110	2.54	2.79
C	.020	.029	0.51	0.74
D	.819	.840	20.80	21.34
E	.770	.799	19.56	20.29
e	.150 BSC		3.81 BSC	
L	.780	.840	19.81	21.34
L1	.083	.102	2.11	2.59
Q	.210	.244	5.33	6.20
R	.100	.180	2.54	4.57
S	.660	.690	16.76	17.53
T	.590	.620	14.99	15.75
U	.065	.080	1.65	2.03

Ref: IXYS CO 0077 R0

Symbol	Test Conditions ³	Characteristic Values				
		Min.	Typ.	Max.		
I_S	$V_{GS} = 0V$			110 A		
I_{SM}	Repetitive, Pulse Width Limited by T_{JM}			440 A		
V_{SD}	$I_F = 100A, V_{GS} = 0V, \text{Note 1}$			1.3 V		
t_{rr}	$I_F = 55A, -di/dt = 100A/\mu\text{s}$ $V_R = 100V, V_{GS} = 0V$		85	ns		
I_{RM}					6.80	A
Q_{RM}					0.29	μC

Note 1: Pulse Test, $t \leq 300\mu\text{s}$, Duty Cycle, $d \leq 2\%$.

ADVANCE TECHNICAL INFORMATION

The product presented herein is under development. The Technical Specifications offered are derived from a subjective evaluation of the design, based upon prior knowledge and experience, and constitute a "considered reflection" of the anticipated objective result. IXYS reserves the right to change limits, test conditions, and dimensions without notice.

IXYS Reserves The Right to Change Limits, Test Conditions, and Dimensions.

IXYS MOSFETs and IGBTs are covered by one or more of the following U.S. patents:	4,835,592	4,931,844	5,049,961	5,237,481	6,162,665	6,404,065 B1	6,683,344	6,727,585	7,005,734 B2	7,157,338B2
	4,850,072	5,017,508	5,063,307	5,381,025	6,259,123 B1	6,534,343	6,710,405 B2	6,759,692	7,063,975 B2	
	4,881,106	5,034,796	5,187,117	5,486,715	6,306,728 B1	6,583,505	6,710,463	6,771,478 B2	7,071,537	

**Fig. 1. Output Characteristics
@ 25°C**

**Fig. 2. Extended Output Characteristics
@ 25°C**

**Fig. 3. Output Characteristics
@ 150°C**

**Fig. 4. $R_{DS(on)}$ Normalized to $I_D = 55\text{A}$ Value
vs. Junction Temperature**

**Fig. 5. $R_{DS(on)}$ Normalized to $I_D = 55\text{A}$ Value
vs. Drain Current**

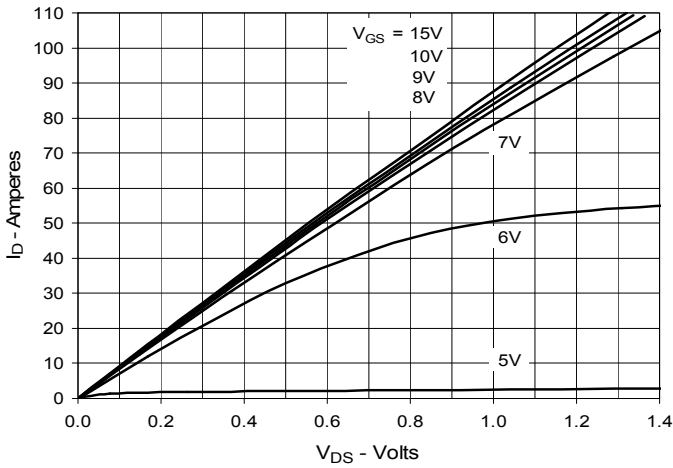
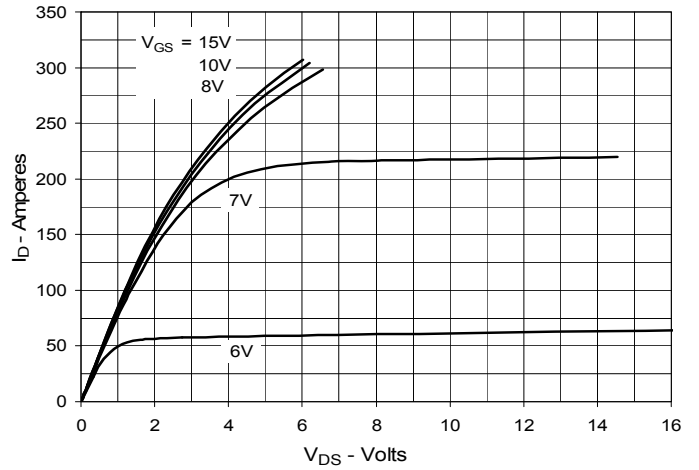
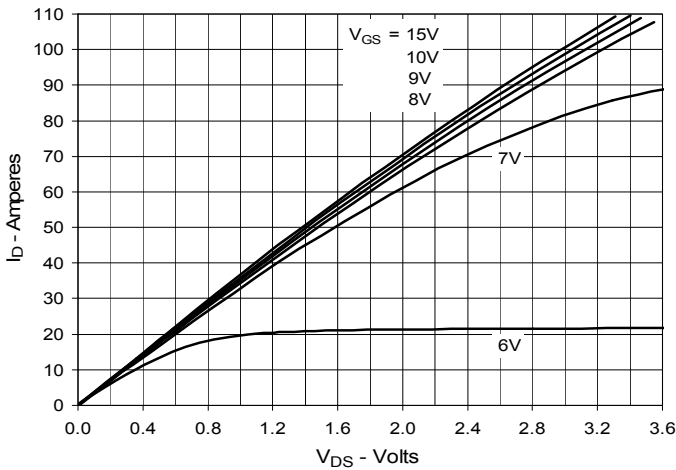
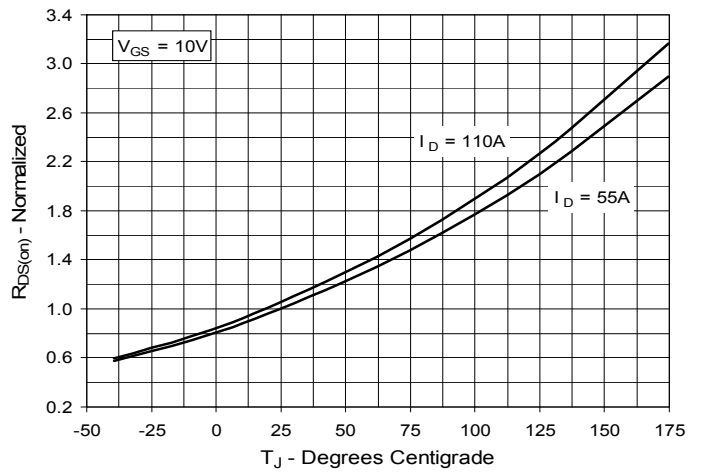
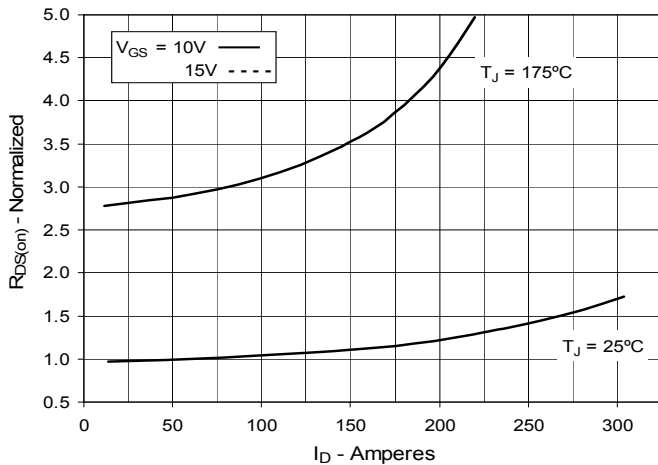
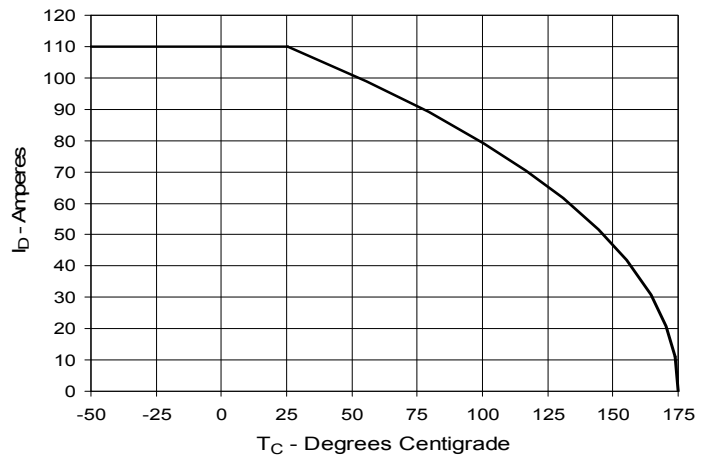
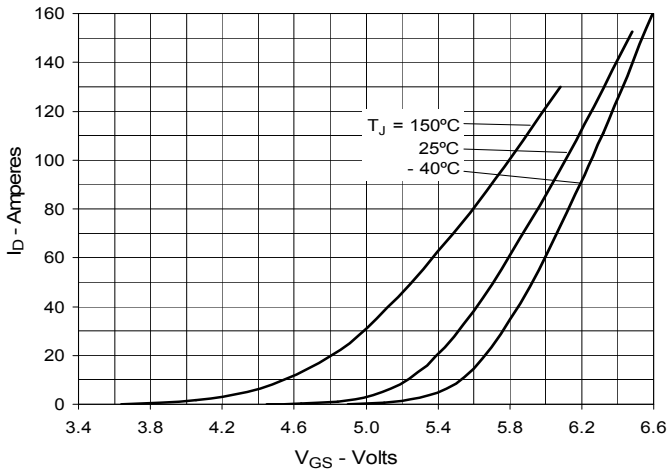
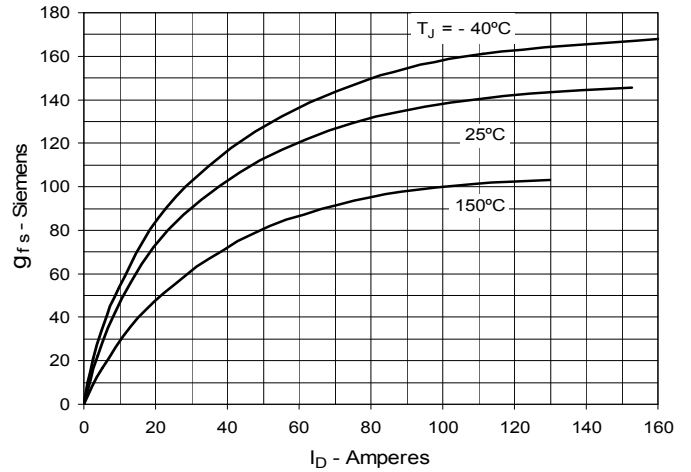
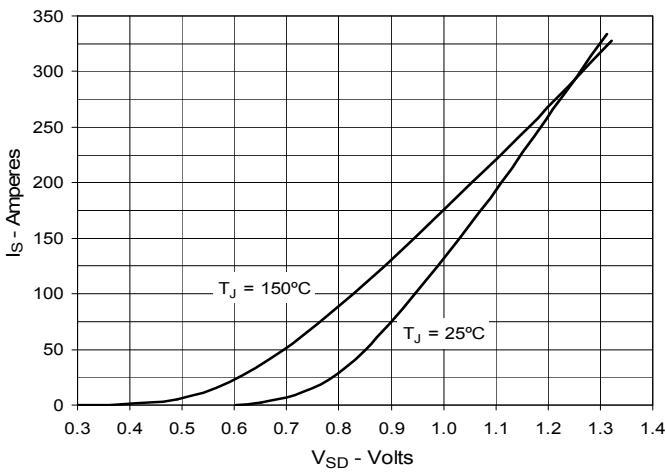
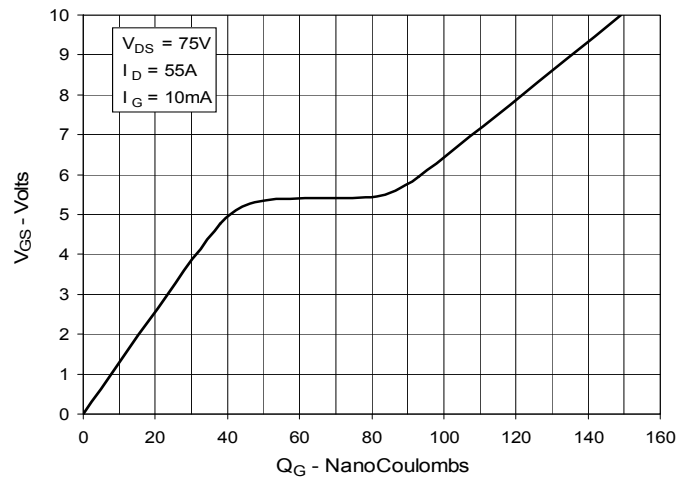
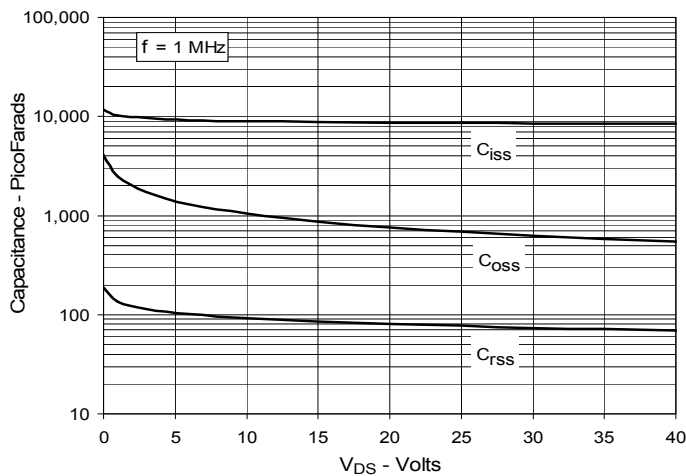
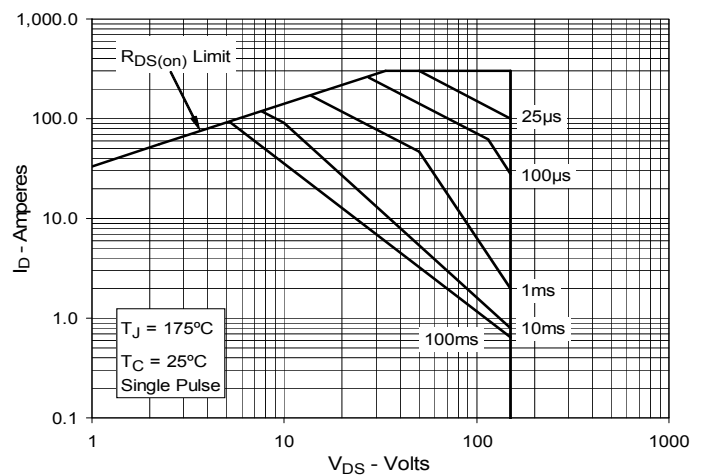
Fig. 6. Drain Current vs. Case Temperature

Fig. 7. Input Admittance

Fig. 8. Transconductance

Fig. 9. Forward Voltage Drop of Intrinsic Diode

Fig. 10. Gate Charge

Fig. 11. Capacitance

Fig. 12. Forward-Bias Safe Operating Area

IXYS Reserves The Right to Change Limits, Test Conditions, and Dimensions.

Fig. 13. Resistive Turn-on Rise Time vs. Junction Temperature

Fig. 14. Resistive Turn-on Rise Time vs. Drain Current

Fig. 15. Resistive Turn-on Switching Times vs. Gate Resistance

Fig. 16. Resistive Turn-off Switching Times vs. Junction Temperature

Fig. 17. Resistive Turn-off Switching Times vs. Drain Current

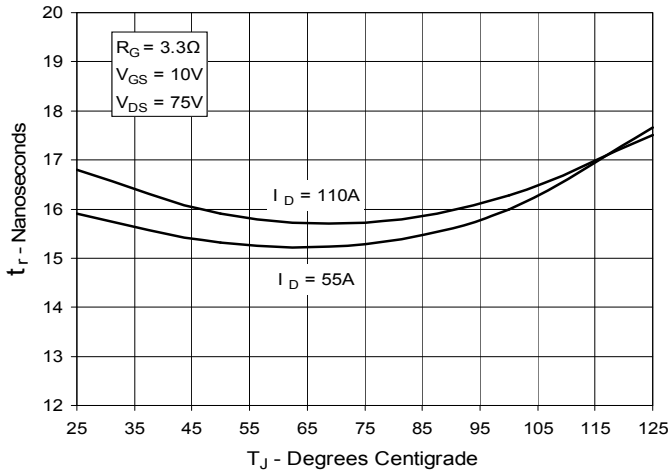
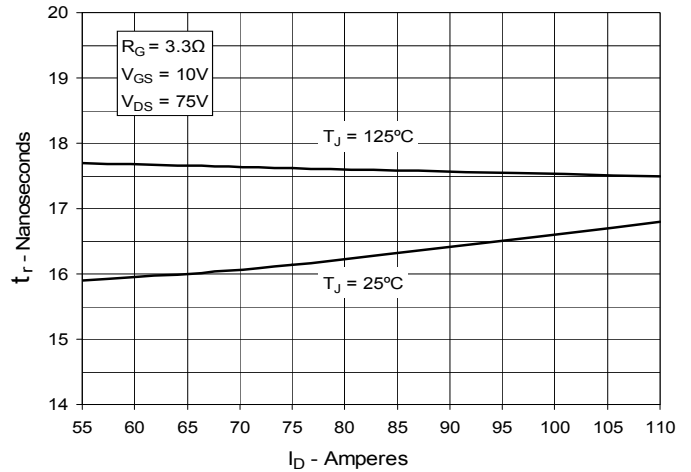
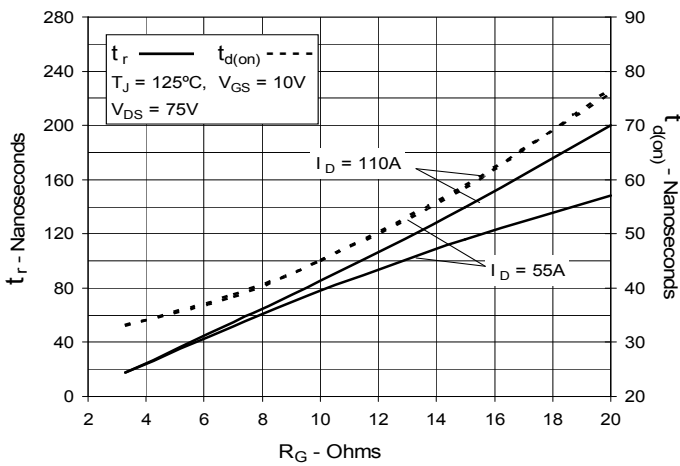
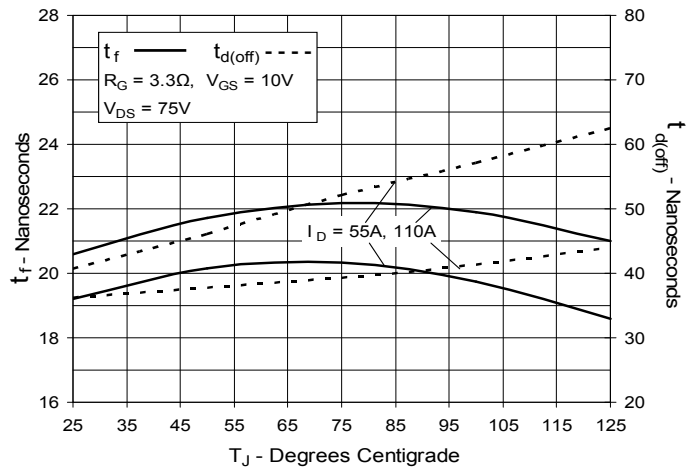
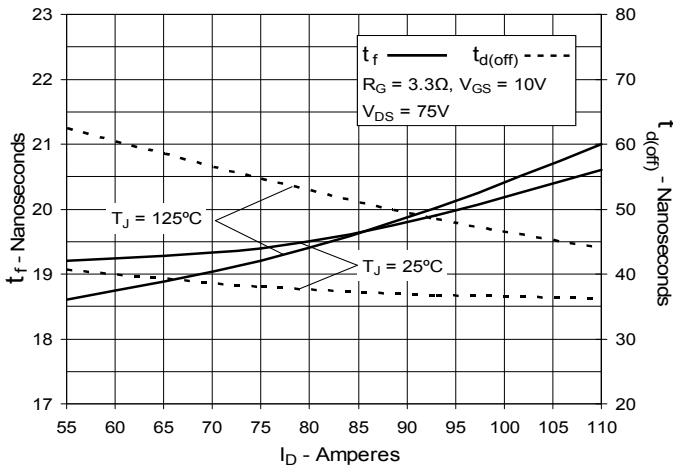
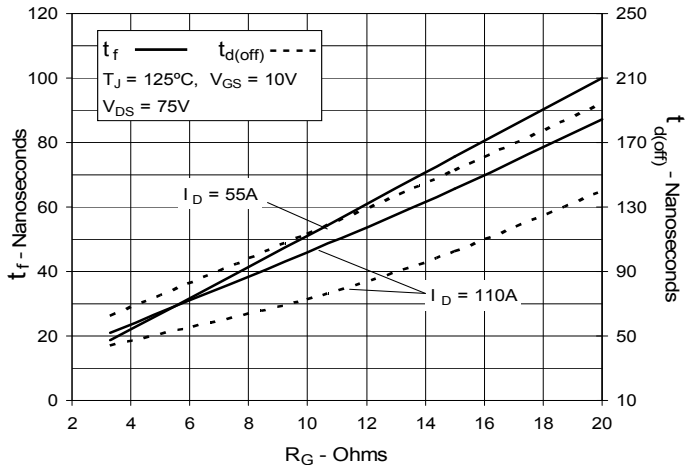
Fig. 18. Resistive Turn-off Switching Times vs. Gate Resistance

Fig. 19. Maximum Transient Thermal Impedance

