

IRF7338PbF

HEXFET® Power MOSFET

- Ultra Low On-Resistance
- Dual N and P Channel MOSFET
- Surface Mount
- Available in Tape & Reel
- Lead-Free

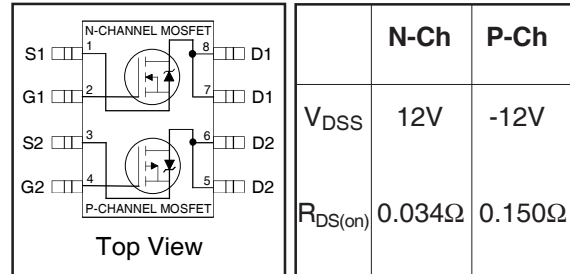

Description

These N and P channel MOSFETs from International Rectifier utilize advanced processing techniques to achieve the extremely low on-resistance per silicon area. This benefit provides the designer with an extremely efficient device for use in battery and load management applications.

This Dual SO-8 has been modified through a customized leadframe for enhanced thermal characteristics and multiple-die capability making it ideal in a variety of power applications. With these improvements, multiple devices can be used in an application with dramatically reduced board space. The package is designed for vapor phase, infrared, or wave soldering techniques.

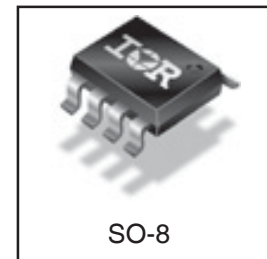

Absolute Maximum Ratings

	Parameter	Max.		Units
		N-Channel	P-Channel	
V_{DS}	Drain-to-Source Voltage	12	-12	A
$I_D @ T_A = 25^\circ\text{C}$	Continuous Drain Current, $V_{GS} @ 4.5\text{V}$	6.3	-3.0	
$I_D @ T_A = 70^\circ\text{C}$	Continuous Drain Current, $V_{GS} @ 4.5\text{V}$	5.2	-2.5	
I_{DM}	Pulsed Drain Current ①	26	-13	
$P_D @ T_A = 25^\circ\text{C}$	Power Dissipation ③	2.0		W
$P_D @ T_A = 70^\circ\text{C}$	Power Dissipation ③	1.3		
	Linear Derating Factor	16		mW/°C
V_{GS}	Gate-to-Source Voltage	±12 ④	± 8.0	V
T_J, T_{STG}	Junction and Storage Temperature Range	-55 to + 150		°C

Thermal Resistance

Symbol	Parameter	Typ.	Max.	Units
$R_{\theta JL}$	Junction-to-Drain Lead	—	20	°C/W
$R_{\theta JA}$	Junction-to-Ambient ③	—	62.5	

www.irf.com

1

9/30/04

Electrical Characteristics @ T_J = 25°C (unless otherwise specified)

Parameter	Parameter		Min.	Typ.	Max.	Units	Conditions
V _{(BR)DSS}	Drain-to-Source Breakdown Voltage	N-Ch	12	—	—	V	V _{GS} = 0V, I _D = 250μA
		P-Ch	-12	—	—		V _{GS} = 0V, I _D = -250μA
ΔV _{(BR)DSS} /ΔT _J	Breakdown Voltage Temp. Coefficient	N-Ch	—	0.01	—	V/°C	Reference to 25°C, I _D = 1mA
		P-Ch	—	-0.01	—		Reference to 25°C, I _D = -1mA
R _{DS(on)}	Static Drain-to-Source On-Resistance	N-Ch	—	—	0.034	Ω	V _{GS} = 4.5V, I _D = 6.0A ②
			—	—	0.060		V _{GS} = 3.0V, I _D = 2.0A ②
		P-Ch	—	—	0.150		V _{GS} = -4.5V, I _D = -2.9A ②
			—	—	0.200		V _{GS} = -2.7V, I _D = -1.5A ②
V _{GS(th)}	Gate Threshold Voltage	N-Ch	0.6	—	1.5	V	V _{DS} = V _{GS} , I _D = 250μA
		P-Ch	-0.40	—	-1.0		V _{DS} = V _{GS} , I _D = -250μA
g _{fs}	Forward Transconductance	N-Ch	9.2	—	—	S	V _{DS} = 6.0V, I _D = 6.0A ②
		P-Ch	3.5	—	—		V _{DS} = -6.0V, I _D = -1.5A ②
I _{DSS}	Drain-to-Source Leakage Current	N-Ch	—	—	20	μA	V _{DS} = 9.6V, V _{GS} = 0V
		P-Ch	—	—	-1.0		V _{DS} = -9.6V, V _{GS} = 0V
		N-Ch	—	—	50		V _{DS} = 9.6V, V _{GS} = 0V, T _J = 55°C
		P-Ch	—	—	-25		V _{DS} = -9.6V, V _{GS} = 0V, T _J = 55°C
I _{GSS}	Gate-to-Source Forward Leakage	N-Ch	—	—	±100	nA	V _{GS} = ±12V
		P-Ch	—	—	±100		V _{GS} = ±8.0V
Q _g	Total Gate Charge	N-Ch	—	—	8.6	nC	N-Channel I _D = 6.0A, V _{DS} = 6.0V, V _{GS} = 4.5V
		P-Ch	—	—	6.6		
Q _{gs}	Gate-to-Source Charge	N-Ch	—	—	1.9		P-Channel I _D = -2.9A, V _{DS} = -9.6V, V _{GS} = -4.5V
		P-Ch	—	—	1.3		
Q _{gd}	Gate-to-Drain ("Miller") Charge	N-Ch	—	—	3.9		
		P-Ch	—	—	1.6		
t _{d(on)}	Turn-On Delay Time	N-Ch	—	6.0	—	ns	N-Channel V _{DD} = 6.0V, I _D = 1.0A, R _G = 6.0Ω, V _{GS} = 4.5V
		P-Ch	—	9.6	—		
t _r	Rise Time	N-Ch	—	7.6	—		②
		P-Ch	—	13	—		
t _{d(off)}	Turn-Off Delay Time	N-Ch	—	26	—		P-Channel V _{DD} = -6.0V, I _D = -2.9A, R _G = 6.0Ω, V _{GS} = -4.5V
		P-Ch	—	27	—		
t _f	Fall Time	N-Ch	—	34	—		
		P-Ch	—	25	—		
C _{iss}	Input Capacitance	N-Ch	—	640	—	pF	N-Channel V _{GS} = 0V, V _{DS} = 9.0V, f = 1.0MHz
		P-Ch	—	490	—		
C _{oss}	Output Capacitance	N-Ch	—	340	—		P-Channel V _{GS} = 0V, V _{DS} = -9.0V, f = 1.0KHz
		P-Ch	—	80	—		
C _{rss}	Reverse Transfer Capacitance	N-Ch	—	110	—		
		P-Ch	—	58	—		

Source-Drain Ratings and Characteristics

Parameter	Parameter		Min.	Typ.	Max.	Units	Conditions
I _S	Continuous Source Current (Body Diode)	N-Ch	—	—	6.3	A	
		P-Ch	—	—	-3.0		
I _{SM}	Pulsed Source Current (Body Diode) ①	N-Ch	—	—	26		
		P-Ch	—	—	-13		
V _{SD}	Diode Forward Voltage	N-Ch	—	—	1.3	V	T _J = 25°C, I _S = 1.7A, V _{GS} = 0V ②
		P-Ch	—	—	-1.2		T _J = 25°C, I _S = -2.9A, V _{GS} = 0V ②
t _{rr}	Reverse Recovery Time	N-Ch	—	51	76	ns	N-Channel T _J = 25°C, I _F = 1.7A, di/dt = 100A/μs
		P-Ch	—	37	56		
Q _{rr}	Reverse Recovery Charge	N-Ch	—	43	64	nC	P-Channel T _J = 25°C, I _F = -2.9A, di/dt = -100A/μs ②
		P-Ch	—	20	30		

Notes:

- ① Repetitive rating; pulse width limited by max. junction temperature.
② Pulse width ≤ 400μs; duty cycle ≤ 2%.

- ③ Surface mounted on 1 in square Cu board.
④ The N-channel MOSFET can withstand 15V V_{GS} max for up to 24 hours over the life of the device.

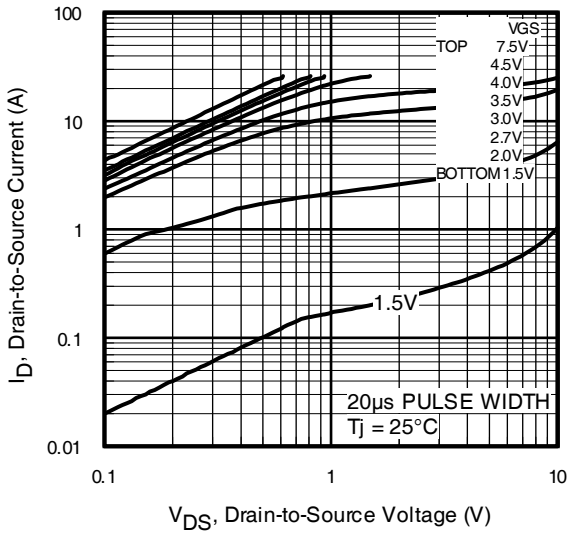

Fig 1. Typical Output Characteristics

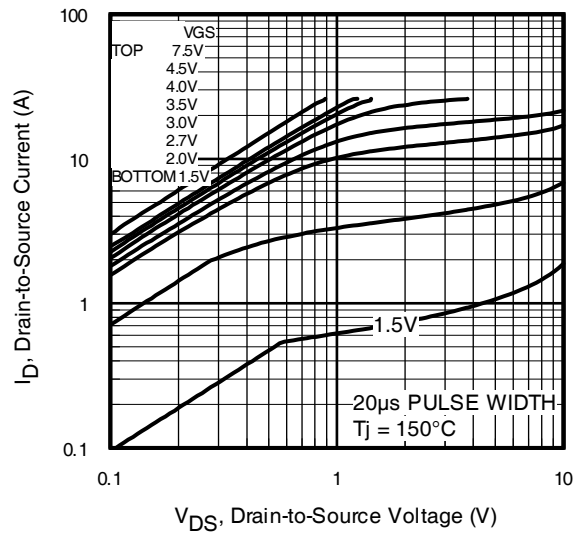

Fig 2. Typical Output Characteristics

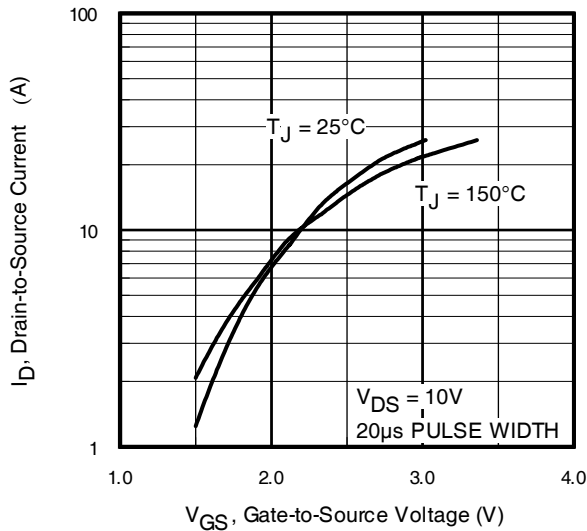

Fig 3. Typical Transfer Characteristics

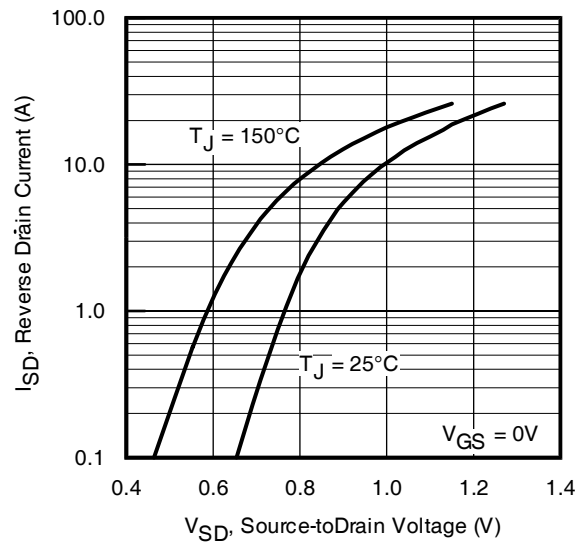

Fig 4. Typical Source-Drain Diode Forward Voltage

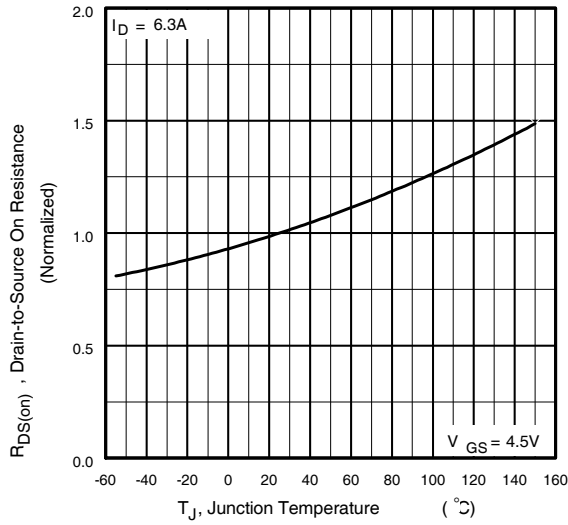

Fig 5. Normalized On-Resistance Vs. Temperature

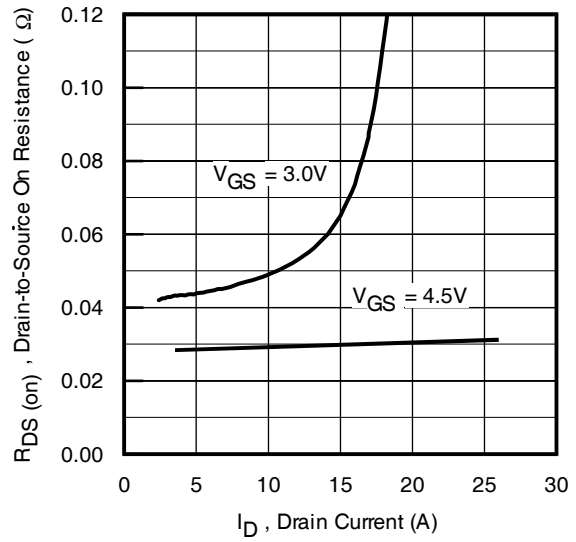

Fig 6. Typical On-Resistance Vs. Drain Current

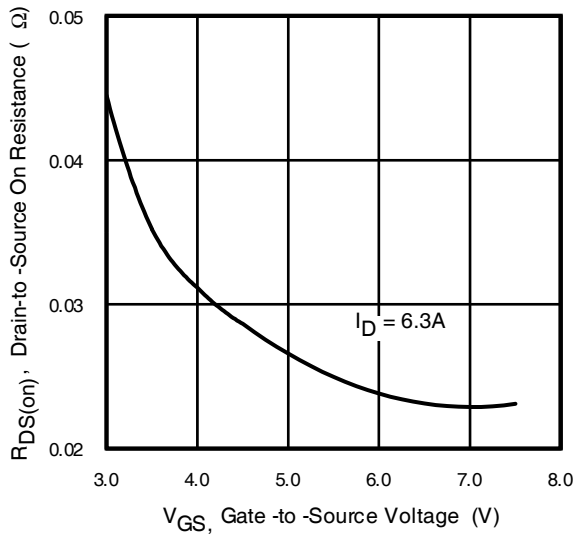

Fig 7. Typical On-Resistance Vs. Gate Voltage

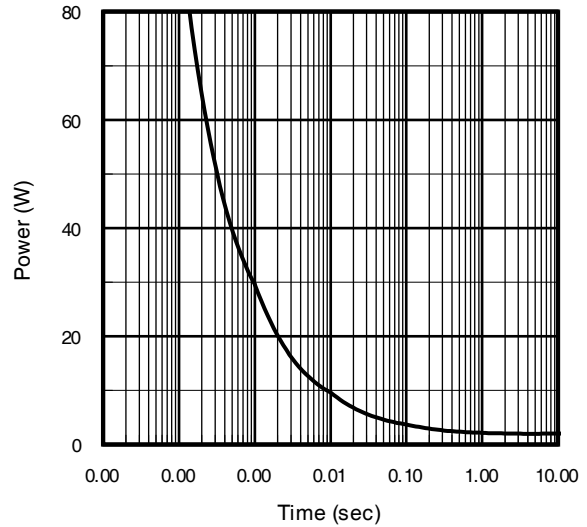

Fig 8. Typical Power Vs. Time

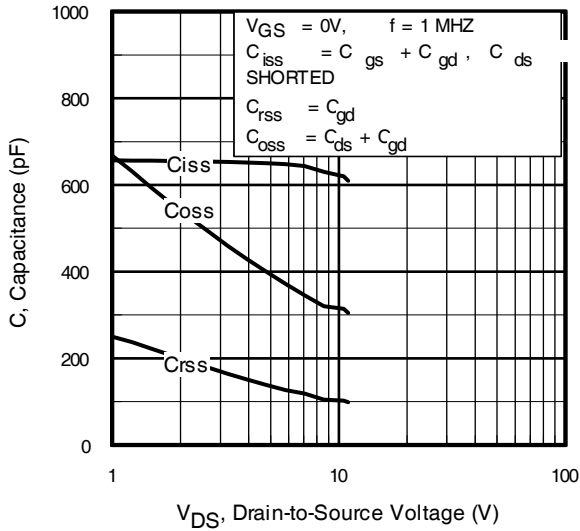

Fig 9. Typical Capacitance Vs. Drain-to-Source Voltage

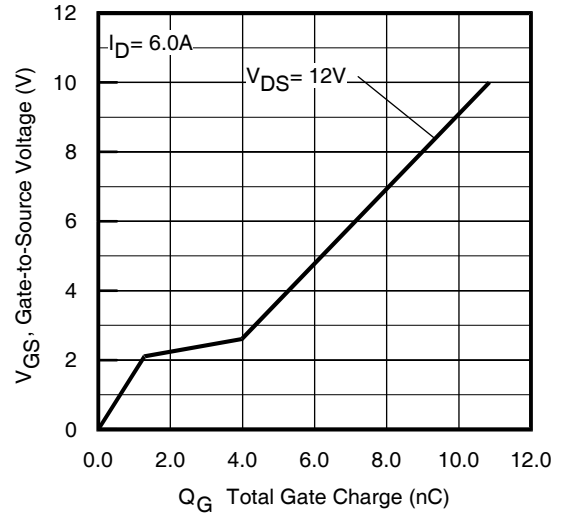

Fig 10. Typical Gate Charge Vs. Gate-to-Source Voltage

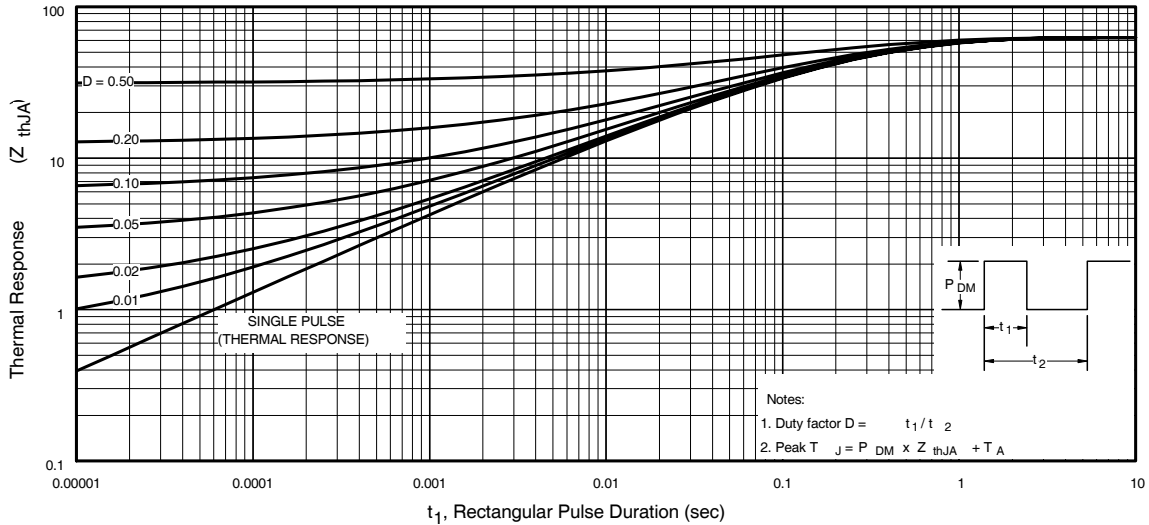

Fig 11. Maximum Effective Transient Thermal Impedance, Junction-to-Ambient

IRF7338PbF

N-Channel

International
IR Rectifier

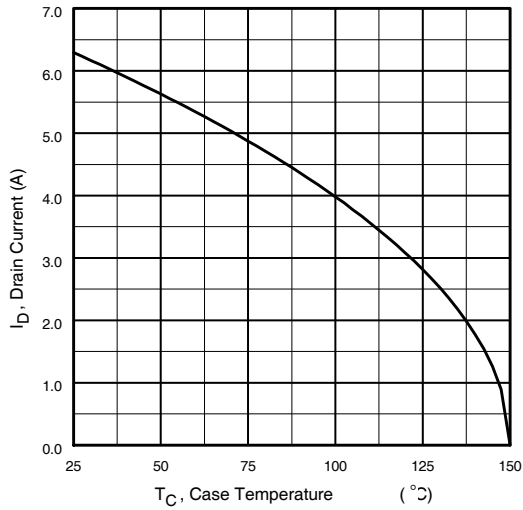

Fig 12. Maximum Drain Current Vs. Case Temperature

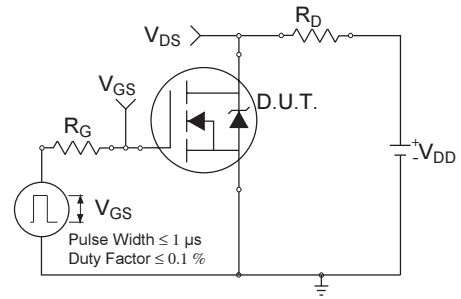

Fig 13a. Switching Time Test Circuit

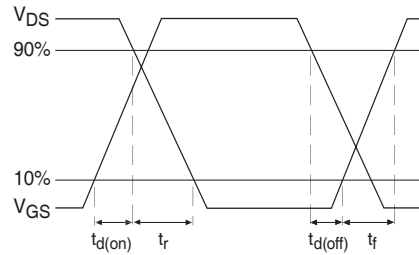

Fig 13b. Switching Time Waveforms

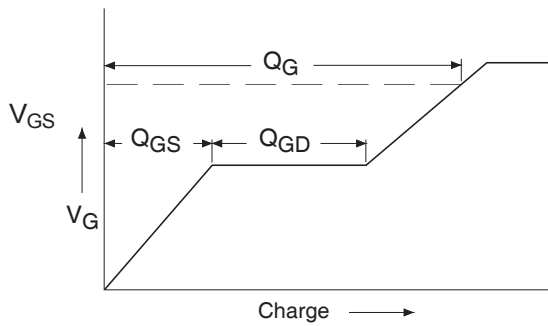

Fig 14a. Basic Gate Charge Waveform

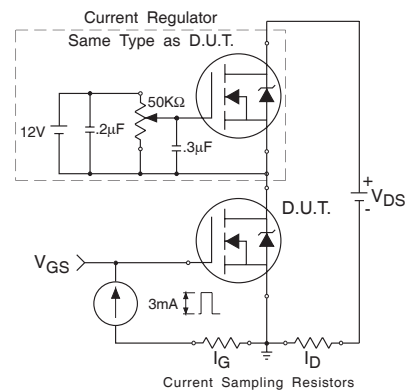

Fig 14b. Gate Charge Test Circuit

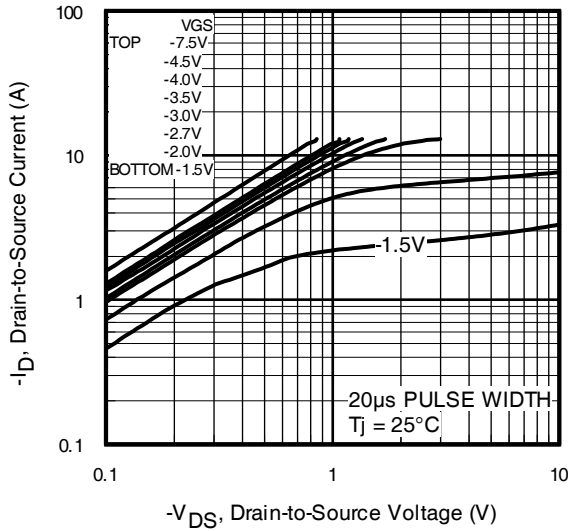

Fig 15. Typical Output Characteristics

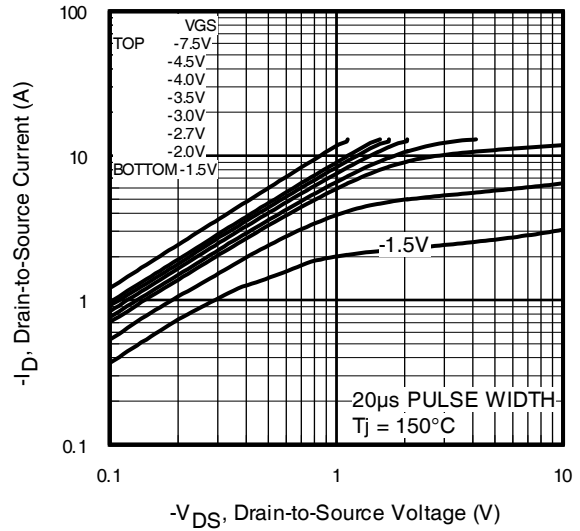

Fig 16. Typical Output Characteristics

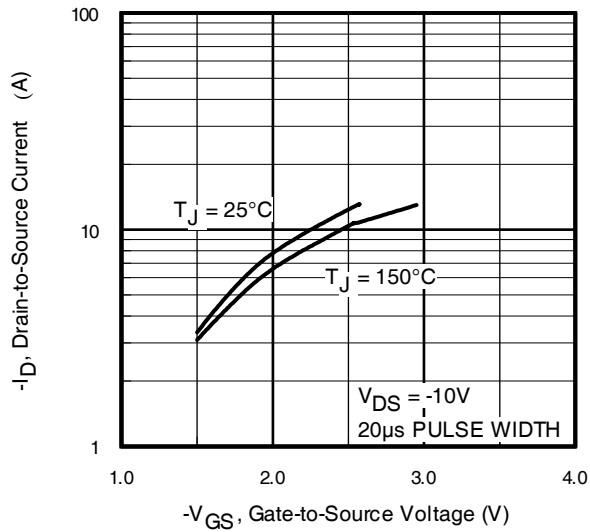

Fig 17. Typical Transfer Characteristics

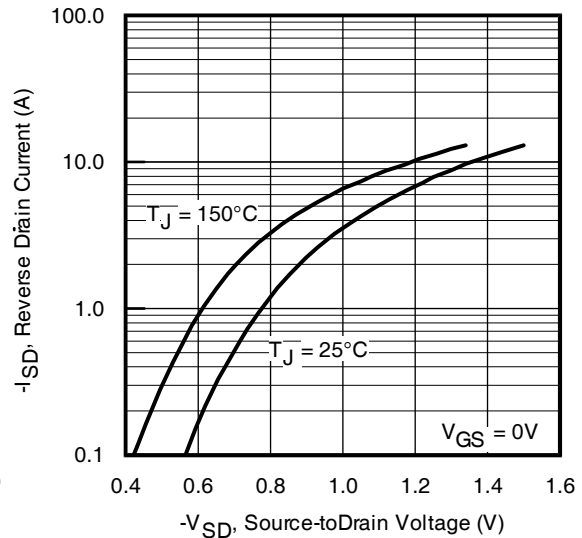

Fig 18. Typical Source-Drain Diode Forward Voltage

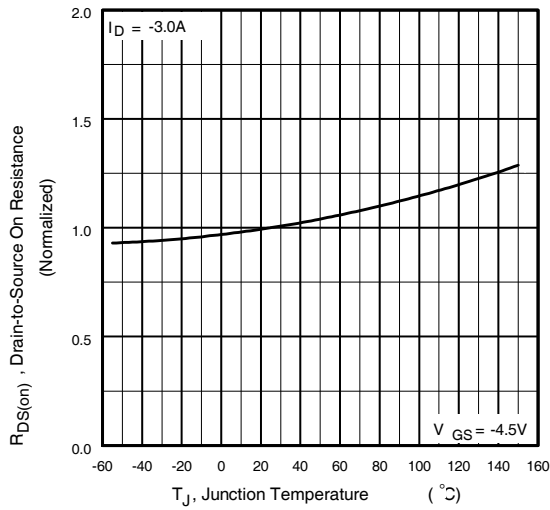

Fig 19. Normalized On-Resistance Vs. Temperature

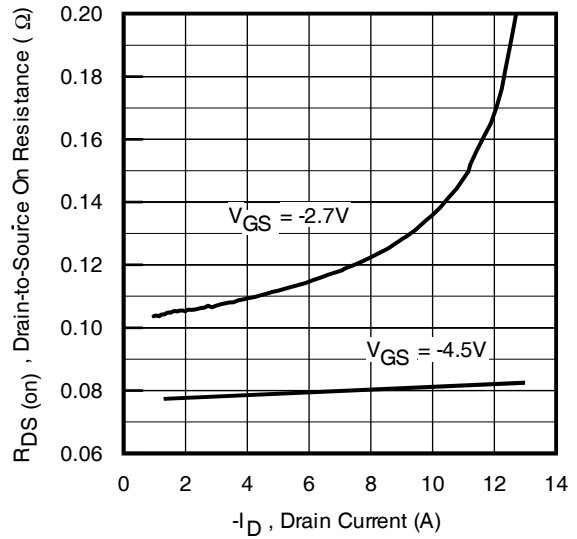

Fig 20. Typical On-Resistance Vs. Drain Current

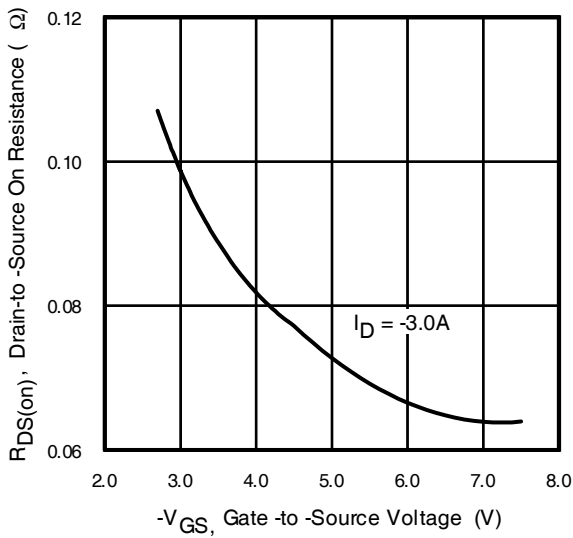

Fig 21. Typical On-Resistance Vs. Gate Voltage

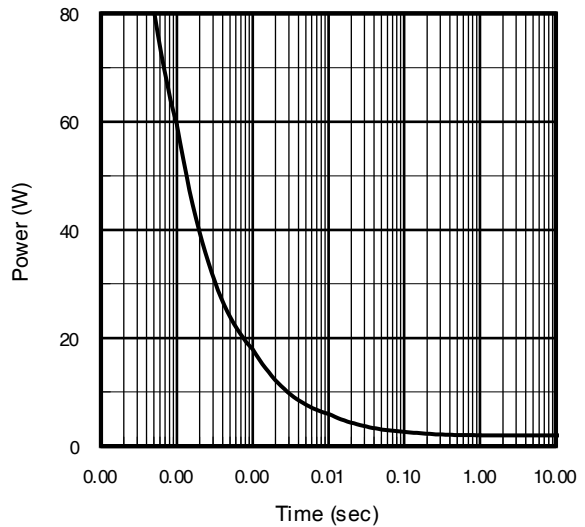

Fig 22. Maximum Avalanche Energy Vs. Drain Current

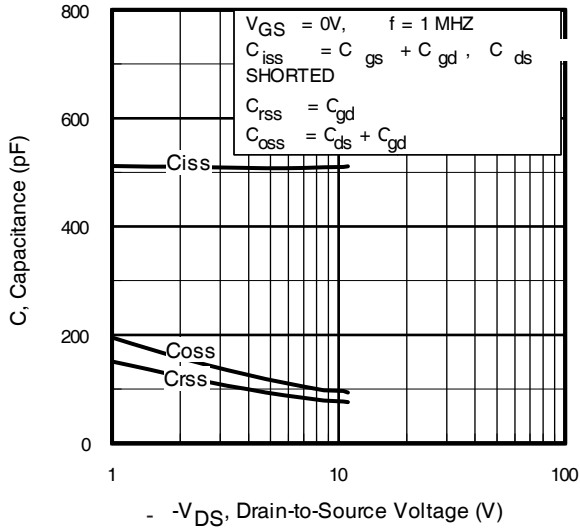

Fig 23. Typical Capacitance Vs. Drain-to-Source Voltage

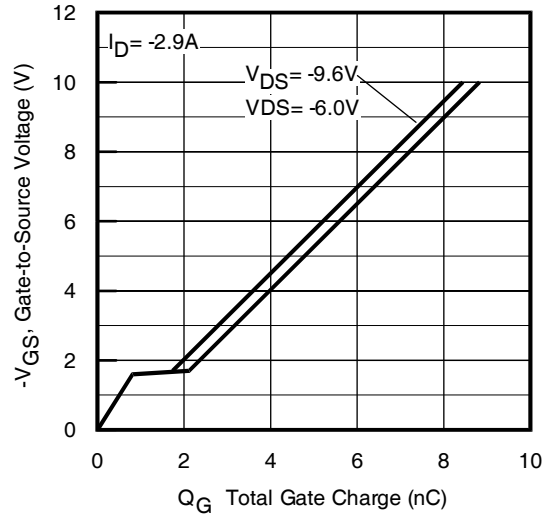

Fig 24. Typical Gate Charge Vs. Gate-to-Source Voltage

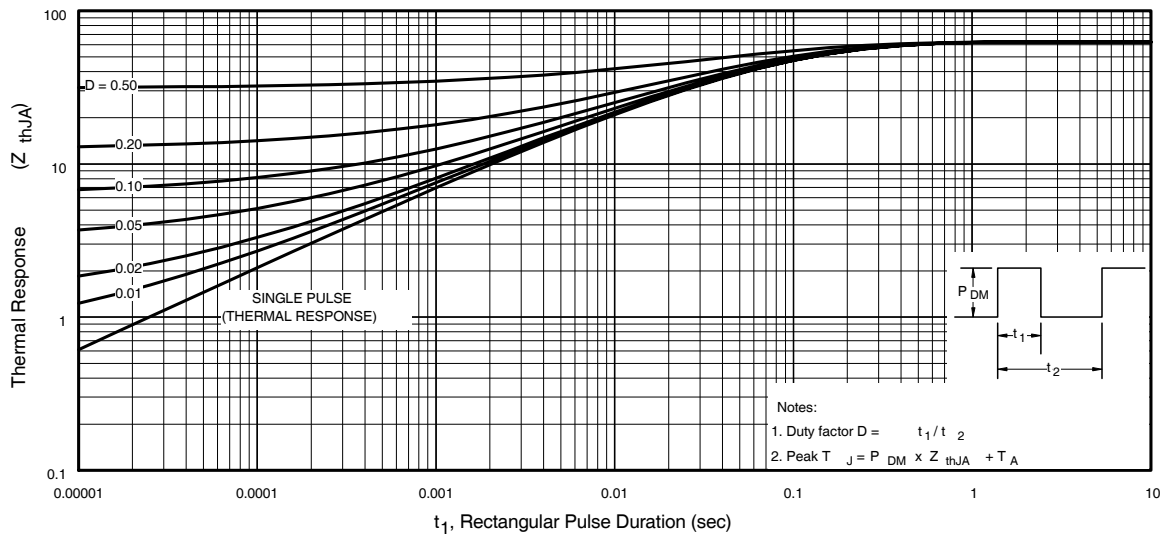

Fig 25. Maximum Effective Transient Thermal Impedance, Junction-to-Ambient

IRF7338PbF

International
IR Rectifier

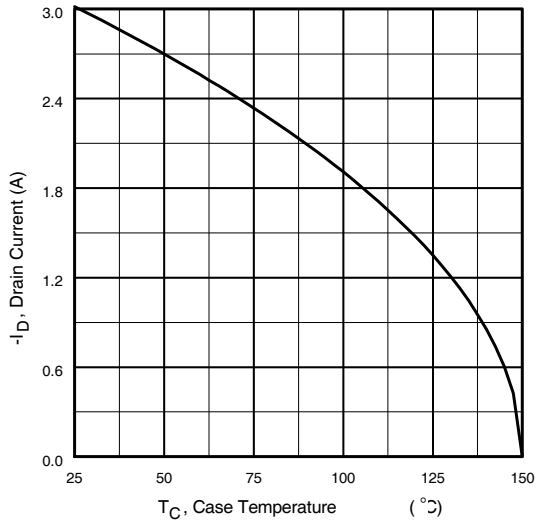

Fig 26. Maximum Drain Current Vs. Case Temperature

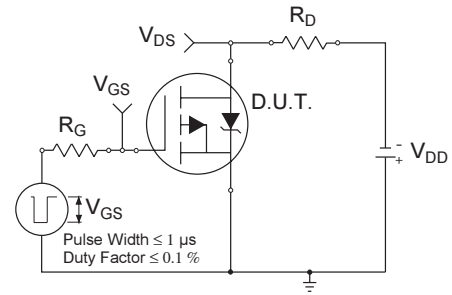

Fig 27a. Switching Time Test Circuit

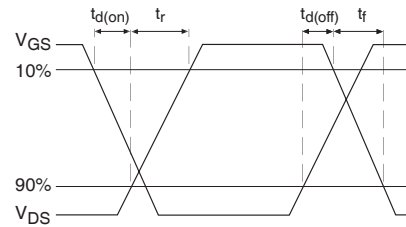

Fig 27b. Switching Time Waveforms

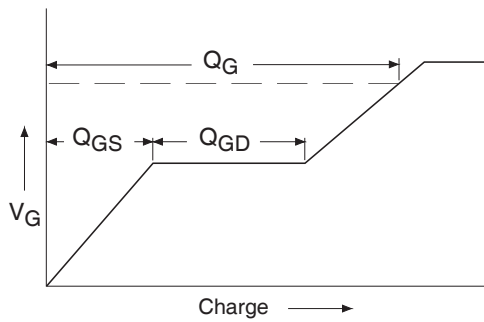

Fig 28a. Basic Gate Charge Waveform

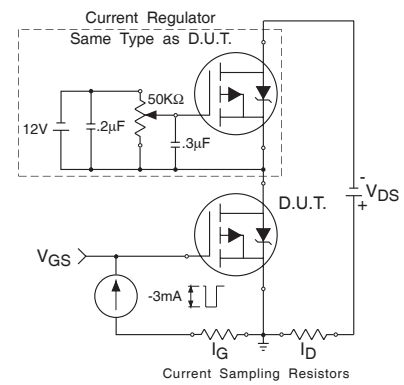
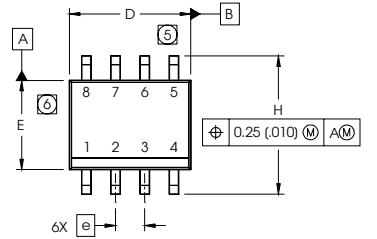

Fig 28b. Gate Charge Test Circuit

SO-8 Package Outline

Dimensions are shown in millimeters (inches)



DIM	INCHES		MILLIMETERS	
	MIN	MAX	MIN	MAX
A	.0532	.0688	1.35	1.75
A1	.0040	.0098	0.10	0.25
b	.013	.020	0.33	0.51
c	.0075	.0098	0.19	0.25
D	.189	.1968	4.80	5.00
E	.1497	.1574	3.80	4.00
e	.050 BASIC		1.27 BASIC	
e1	.025 BASIC		0.635 BASIC	
H	.2284	.2440	5.80	6.20
K	.0099	.0196	0.25	0.50
L	.016	.050	0.40	1.27
y	0°	8°	0°	8°

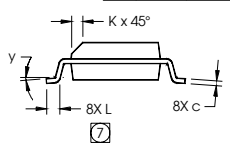
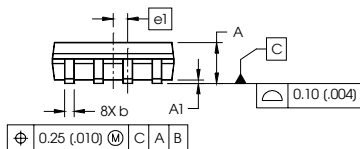

NOTES:

1. DIMENSIONING & TOLERANCING PER ASME Y14.5M-1994.
2. CONTROLLING DIMENSION: MILLIMETER
3. DIMENSIONS ARE SHOWN IN MILLIMETERS (INCHES).
4. OUTLINE CONFORMS TO JEDEC OUTLINE MS-012AA
- ⑤ DIMENSION DOES NOT INCLUDE MOLD PROTRUSIONS. MOLD PROTRUSIONS NOT TO EXCEED 0.15 (.006).
- ⑥ DIMENSION DOES NOT INCLUDE MOLD PROTRUSIONS. MOLD PROTRUSIONS NOT TO EXCEED 0.25 (.010).
- ⑦ DIMENSION IS THE LENGTH OF LEAD FOR SOLDERING TO A SUBSTRATE.

FOOTPRINT

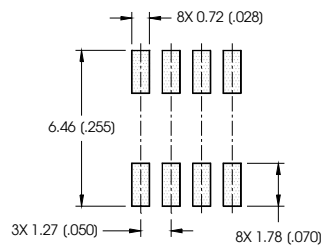

SO-8 Part Marking Information (Lead-Free)

EXAMPLE: THIS IS AN IRF7101 (MOSFET)

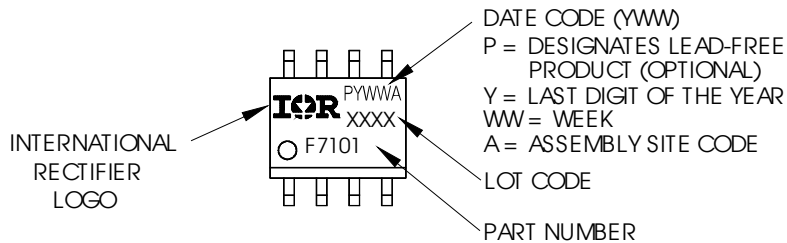

IRF7338PbF

International
IR Rectifier

SO-8 Tape and Reel

Dimensions are shown in millimeters (inches)

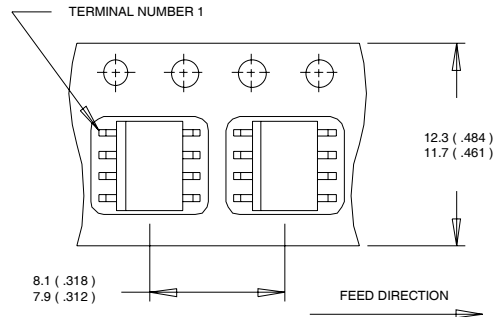

NOTES:

1. CONTROLLING DIMENSION : MILLIMETER.
2. ALL DIMENSIONS ARE SHOWN IN MILLIMETERS(INCHES).
3. OUTLINE CONFORMS TO EIA-481 & EIA-541.

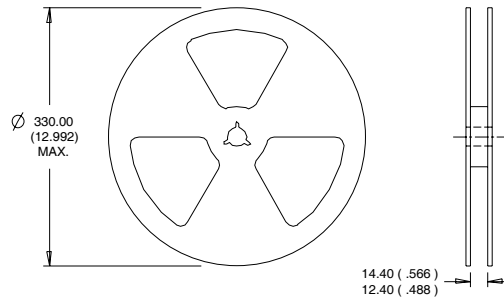

NOTES :

1. CONTROLLING DIMENSION : MILLIMETER.
2. OUTLINE CONFORMS TO EIA-481 & EIA-541.

Data and specifications subject to change without notice.
This product has been designed and qualified for the Consumer market.
Qualification Standards can be found on IR's Web site.

International
IR Rectifier

IR WORLD HEADQUARTERS: 233 Kansas St., El Segundo, California 90245, USA Tel: (310) 252-7105
TAC Fax: (310) 252-7903

Visit us at www.irf.com for sales contact information.09/04

www.irf.com