

# ZXMN6A11DN8

## 60V SO8 Dual N-channel enhancement mode MOSFET

### Summary

$V_{(BR)DSS}$	$R_{DS(on)}$ ( $\Omega$ )	$I_D$ (A)
60	0.120 @ $V_{GS}= 10V$	3.2
	0.180 @ $V_{GS}= 4.5V$	2.6

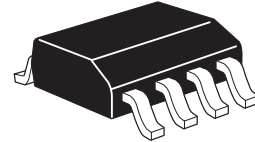

### Description

This new generation trench MOSFET from Zetex features a unique structure combining the benefits of low on-resistance and fast switching, making it ideal for high efficiency power management applications.

### Features

- Low on-resistance
- Fast switching speed
- Low threshold
- Low gate drive
- Low profile SOIC package

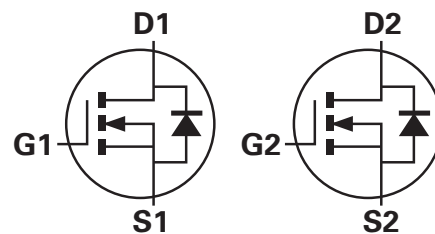

### Applications

- DC-DC converters
- Power management functions
- Motor control

### Ordering information

Device	Reel size (inches)	Tape width (mm)	Quantity per reel
ZXMN6A11DN8TA	7	12	500

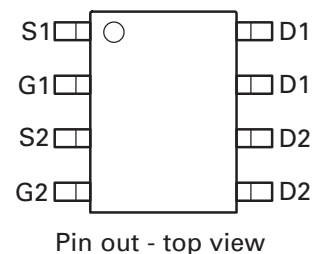

### Device marking

ZXMN  
6A11D

# ZXMN6A11DN8

## Absolute maximum ratings

Parameter	Symbol	Limit	Unit
Drain-source voltage	$V_{DSS}$	60	V
Gate-source voltage	$V_{GS}$	$\pm 20$	V
Continuous drain current @ $V_{GS} = 10V$ ; $T_{amb} = 25^{\circ}C^{(b)}$ @ $V_{GS} = 10V$ ; $T_{amb} = 70^{\circ}C^{(b)}$ @ $V_{GS} = 10V$ ; $T_{amb} = 25^{\circ}C^{(a)}$	$I_D$	3.2	A
		2.6	
		2.5	
Pulsed drain current <sup>(c)</sup>	$I_{DM}$	13.7	A
Continuous source current (body diode) <sup>(b)</sup>	$I_S$	3.1	A
Pulsed source current (body diode) <sup>(c)</sup>	$I_{SM}$	13.7	A
Power dissipation at $T_{amb} = 25^{\circ}C^{(a)(d)}$	$P_D$	1.25	W
Linear derating factor		10	mW/ $^{\circ}C$
Power dissipation at $T_{amb} = 25^{\circ}C^{(a)(e)}$	$P_D$	1.8	W
Linear derating factor		14	mW/ $^{\circ}C$
Power dissipation at $T_{amb} = 25^{\circ}C^{(b)(d)}$	$P_D$	2.1	W
Linear derating factor		17	mW/ $^{\circ}C$
Operating and storage temperature range	$T_j, T_{stg}$	-55 to +150	$^{\circ}C$

## Thermal resistance

Parameter	Symbol	Limit	Unit
Junction to ambient <sup>(a)(d)</sup>	$R_{\theta JA}$	100	$^{\circ}C/W$
Junction to ambient <sup>(a)(e)</sup>	$R_{\theta JA}$	70	$^{\circ}C/W$
Junction to ambient <sup>(b)(d)</sup>	$R_{\theta JA}$	60	$^{\circ}C/W$

### NOTES:

- (a) For a device surface mounted on 25mm x 25mm FR4 PCB with high coverage of single sided 1oz copper, in still air conditions.
- (b) For a device surface mounted on FR4 PCB measured at  $t \leq 10$  sec.
- (c) Repetitive rating - 25mm x 25mm FR4 PCB,  $D=0.02$ , pulse width 300 $\mu s$  - pulse width limited by maximum junction temperature.
- (d) For a dual device with one active die.
- (e) For a device with two active die running at equal power.

# ZXMN6A11DN8

## Typical characteristics

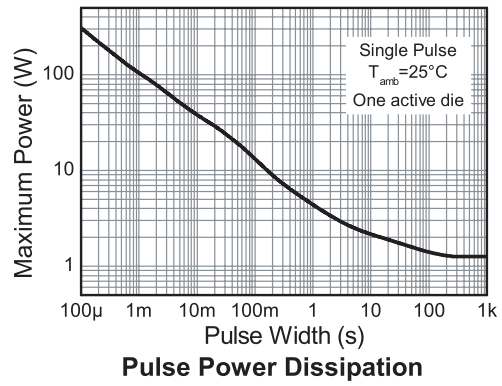
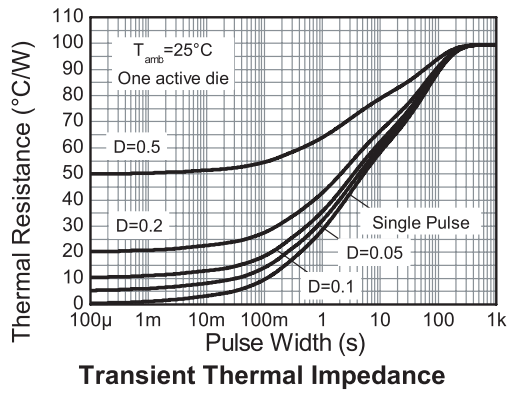
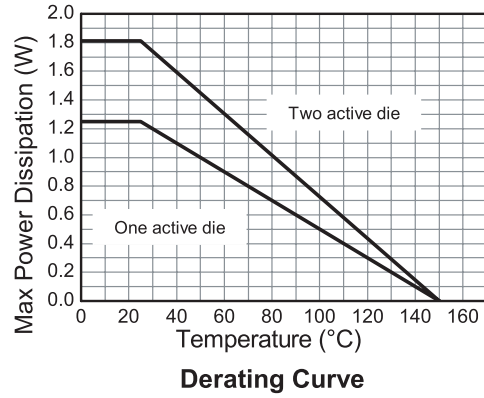
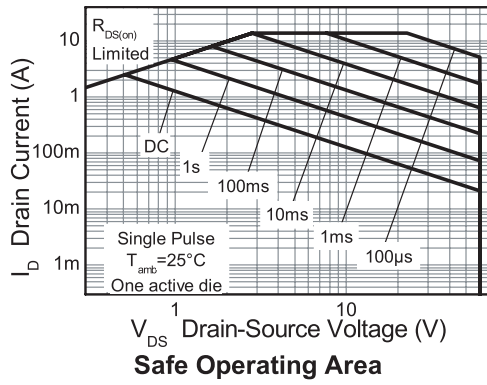

# ZXMN6A11DN8

## Electrical characteristics (at $T_{amb} = 25^{\circ}\text{C}$ unless otherwise stated)

Parameter	Symbol	Min.	Typ.	Max.	Unit	Conditions
<b>Static</b>						
Drain-source breakdown voltage	$V_{(BR)DSS}$	60			V	$I_D = 250\mu\text{A}$ , $V_{GS} = 0\text{V}$
Zero gate voltage drain current	$I_{DSS}$			1.0	$\mu\text{A}$	$V_{DS} = 60\text{V}$ , $V_{GS} = 0\text{V}$
Gate-body leakage	$I_{GSS}$			100	nA	$V_{GS} = \pm 20\text{V}$ , $V_{DS} = 0\text{V}$
Gate-source threshold voltage	$V_{GS(th)}$	1.0			V	$I_D = 250\mu\text{A}$ , $V_{DS} = V_{GS}$
Static drain-source on-state resistance (*)	$R_{DS(on)}$			0.120	$\Omega$	$V_{GS} = 10\text{V}$ , $I_D = 2.5\text{A}$
				0.180	$\Omega$	$V_{GS} = 4.5\text{V}$ , $I_D = 2\text{A}$
Forward transconductance(*) (‡)	$g_{fs}$		4.9		S	$V_{DS} = 15\text{V}$ , $I_D = 2.5\text{A}$
<b>Dynamic (‡)</b>						
Input capacitance	$C_{iss}$		330		pF	$V_{DS} = 40\text{V}$ , $V_{GS} = 0\text{V}$ $f = 1\text{MHz}$
Output capacitance	$C_{oss}$		35.2		pF	
Reverse transfer capacitance	$C_{rss}$		17.1		pF	
<b>Switching (†) (‡)</b>						
Turn-on-delay time	$t_{d(on)}$		1.95		ns	$V_{DD} = 30\text{V}$ , $I_D = 2.5\text{A}$ $R_G = 6.0\Omega$ , $V_{GS} = 10\text{V}$
Rise time	$t_r$		3.5		ns	
Turn-off delay time	$t_{d(off)}$		8.2		ns	
Fall time	$t_f$		4.6		ns	
Gate charge	$Q_g$		3.0		nC	$V_{DS} = 15\text{V}$ , $V_{GS} = 5\text{V}$ $I_D = 2.5\text{A}$
Total gate charge	$Q_g$		5.7		nC	$V_{DS} = 15\text{V}$ , $V_{GS} = 10\text{V}$ $I_D = 2.5\text{A}$
Gate-source charge	$Q_{gs}$		1.25		nC	
Gate drain charge	$Q_{gd}$		0.86		nC	
<b>Source-drain diode</b>						
Diode forward voltage(*)	$V_{SD}$		0.85	0.95	V	$T_j = 25^{\circ}\text{C}$ , $I_S = 2.8\text{A}$ , $V_{GS} = 0\text{V}$
Reverse recovery time (‡)	$t_{rr}$		21.5		ns	$T_j = 25^{\circ}\text{C}$ , $I_S = 2.5\text{A}$ , $di/dt = 100\text{A}/\mu\text{s}$
Reverse recovery charge (‡)	$Q_{rr}$		20.5		nC	

### NOTES:

(\*) Measured under pulsed conditions. Pulse width =  $300\mu\text{s}$ . Duty cycle  $\leq 2\%$ .

(†) Switching characteristics are independent of operating junction temperature.

(‡) For design aid only, not subject to production testing.

# ZXMN6A11DN8

## Typical characteristics

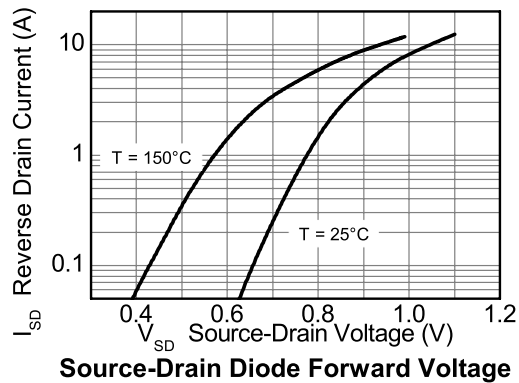
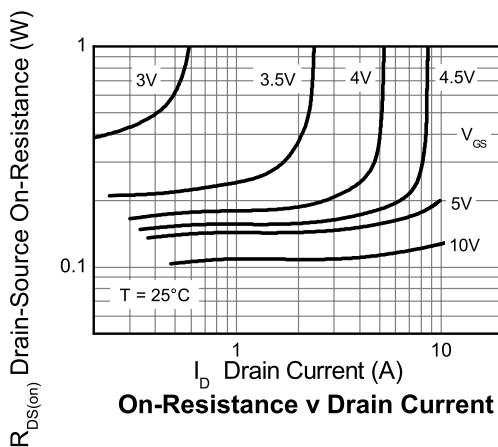
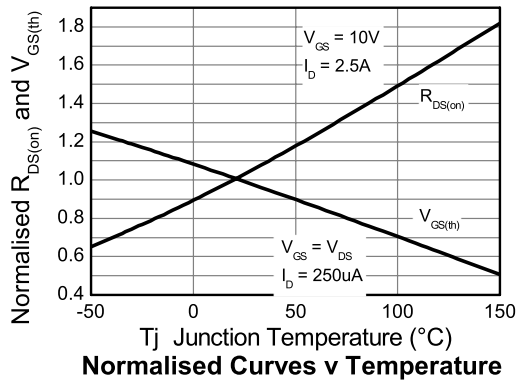
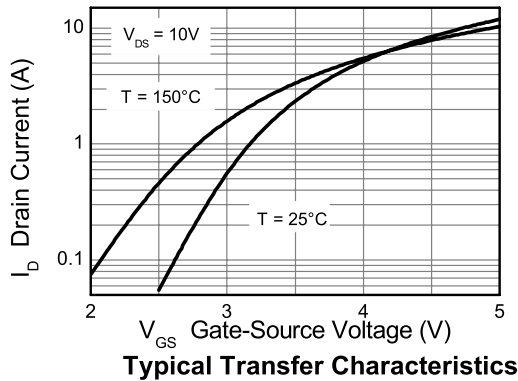
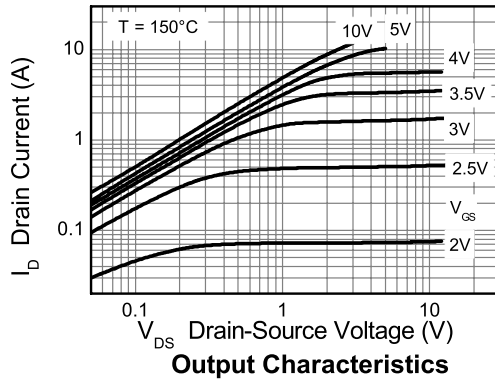
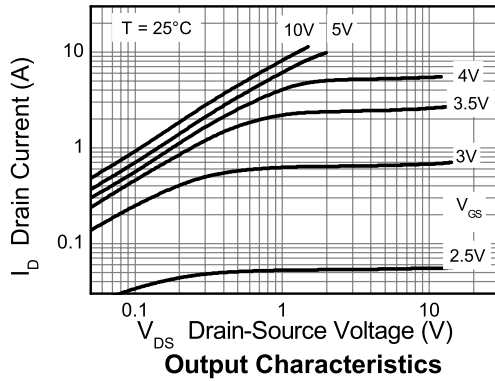

# ZXMN6A11DN8

## Typical characteristics

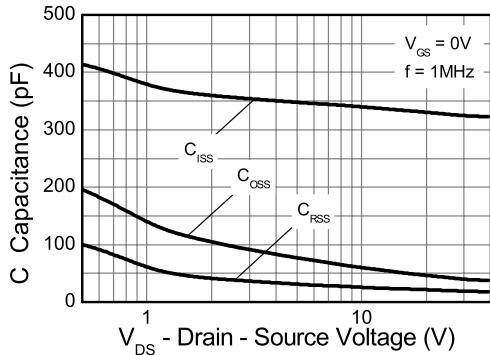

Capacitance v Drain-Source Voltage

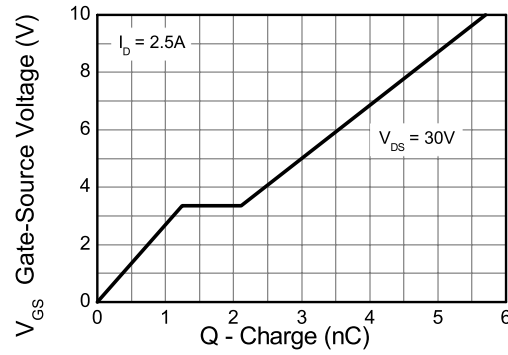

Gate-Source Voltage v Gate Charge

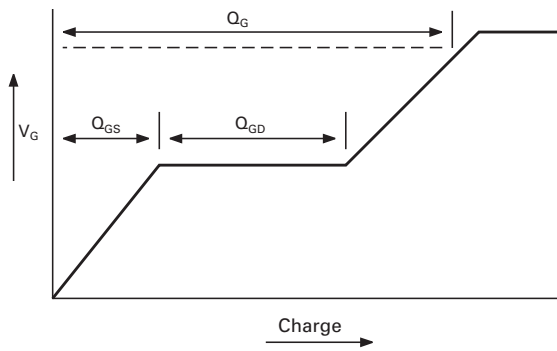

Basic gate charge waveform

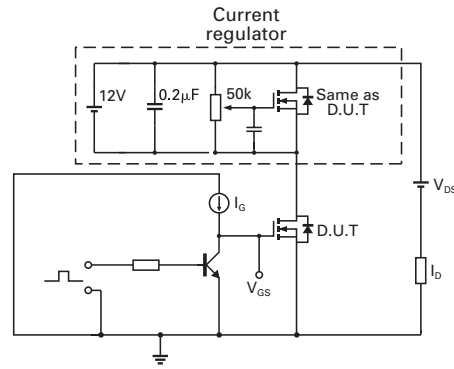

Gate charge test circuit

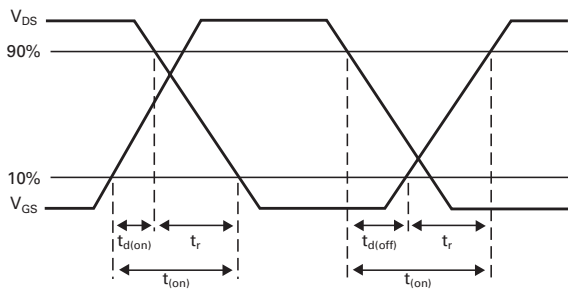

Switching time waveforms

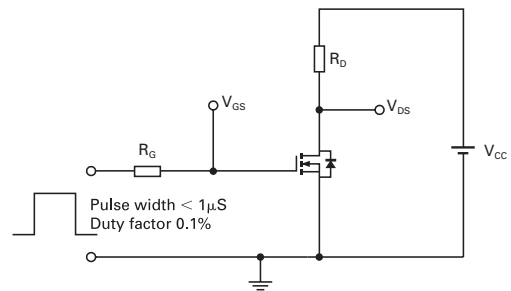

Switching time test circuit

# ZXMN6A11DN8

Intentionally left blank

# ZXMN6A11DN8

## Package outline - SO8

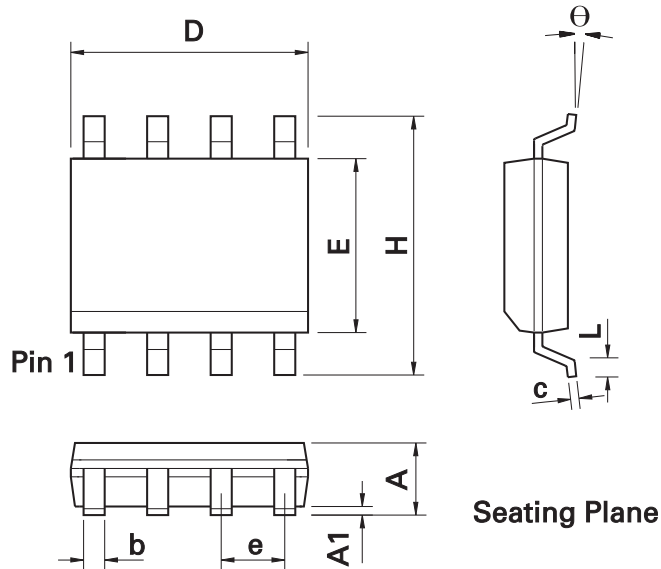

DIM	Inches		Millimeters		DIM	Inches		Millimeters	
	Min.	Max.	Min.	Max.		Min.	Max.	Min.	Max.
A	0.053	0.069	1.35	1.75	e	0.050 BSC		1.27 BSC	
A1	0.004	0.010	0.10	0.25	b	0.013	0.020	0.33	0.51
D	0.189	0.197	4.80	5.00	c	0.008	0.010	0.19	0.25
H	0.228	0.244	5.80	6.20	Θ	0°	8°	0°	8°
E	0.150	0.157	3.80	4.00	h	0.010	0.020	0.25	0.50
L	0.016	0.050	0.40	1.27	-	-	-	-	-

**Note:** Controlling dimensions are in inches. Approximate dimensions are provided in millimeters

Europe	Americas	Asia Pacific	Corporate Headquarters
Zetex GmbH Kustermann-park Balanstraße 59 D-81541 München Germany Telefon: (49) 89 45 49 49 0 Fax: (49) 89 45 49 49 49 europe.sales@zetex.com	Zetex Inc 700 Veterans Memorial Highway Hauppauge, NY 11788 USA Telephone: (1) 631 360 2222 Fax: (1) 631 360 8222 usa.sales@zetex.com	Zetex (Asia Ltd) 3701-04 Metroplaza Tower 1 Hing Fong Road, Kwai Fong Hong Kong Telephone: (852) 26100 611 Fax: (852) 24250 494 asia.sales@zetex.com	Zetex Semiconductors plc Zetex Technology Park, Chadderton Oldham, OL9 9LL United Kingdom Telephone: (44) 161 622 4444 Fax: (44) 161 622 4446 hq@zetex.com

For international sales offices visit [www.zetex.com/offices](http://www.zetex.com/offices)

Zetex products are distributed worldwide. For details, see [www.zetex.com/salesnetwork](http://www.zetex.com/salesnetwork)

This publication is issued to provide outline information only which (unless agreed by the company in writing) may not be used, applied or reproduced for any purpose or form part of any order or contract or be regarded as a representation relating to the products or services concerned. The company reserves the right to alter without notice the specification, design, price or conditions of supply of any product or service.