

IRF7331PbF

HEXFET® Power MOSFET

- Ultra Low On-Resistance
- Dual N-Channel MOSFET
- Surface Mount
- Available in Tape & Reel
- Lead-Free

V _{DSS}	R _{DS(on)} max (mΩ)	I _D
20V	30 @ V _{GS} = 4.5V	7.0A
	45 @ V _{GS} = 2.5V	5.6A

Description

These N-Channel HEXFET® power MOSFETs from International Rectifier utilize advanced processing techniques to achieve the extremely low on-resistance per silicon area. This benefit provides the designer with an extremely efficient device for use in battery and load management applications.

The SO-8 has been modified through a customized leadframe for enhanced thermal characteristics and multiple-die capability making it ideal in a variety of power applications. With these improvements, multiple devices can be used in an application with dramatically reduced board space. The package is designed for vapor phase, infrared, or wave soldering techniques.

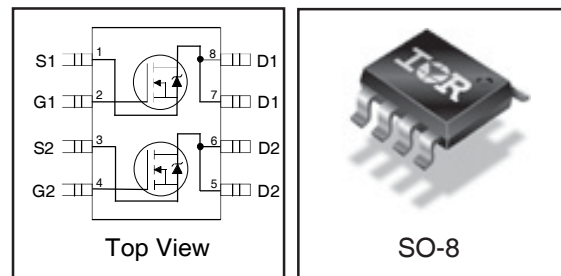

Absolute Maximum Ratings

	Parameter	Max.	Units
V _{DS}	Drain- Source Voltage	20	V
I _D @ T _A = 25°C	Continuous Drain Current, V _{GS} @ 4.5V	7.0	A
I _D @ T _A = 70°C	Continuous Drain Current, V _{GS} @ 4.5V	5.5	
I _{DM}	Pulsed Drain Current ①	28	
P _D @ T _A = 25°C	Power Dissipation ③	2.0	W
P _D @ T _A = 70°C	Power Dissipation ③	1.3	
	Linear Derating Factor	16	mW/°C
V _{GS}	Gate-to-Source Voltage	± 12	V
T _J , T _{STG}	Junction and Storage Temperature Range	-55 to + 150	°C

Thermal Resistance

Symbol	Parameter	Typ.	Max.	Units
R _{θJL}	Junction-to-Drain Lead	—	42	°C/W
R _{θJA}	Junction-to-Ambient ③	—	62.5	

www.irf.com

1

07/09/08

IRF7331PbF

International
IR Rectifier

Electrical Characteristics @ $T_J = 25^\circ\text{C}$ (unless otherwise specified)

	Parameter	Min.	Typ.	Max.	Units	Conditions
$V_{(BR)DSS}$	Drain-to-Source Breakdown Voltage	20	—	—	V	$V_{GS} = 0V, I_D = 250\mu A$
$\Delta V_{(BR)DSS}/\Delta T_J$	Breakdown Voltage Temp. Coefficient	—	0.013	—	V/°C	Reference to $25^\circ\text{C}, I_D = 1\text{mA}$
$R_{DS(on)}$	Static Drain-to-Source On-Resistance	—	—	30	m Ω	$V_{GS} = 4.5V, I_D = 7.0A$ ②
		—	—	45		$V_{GS} = 2.5V, I_D = 5.6A$ ②
$V_{GS(th)}$	Gate Threshold Voltage	0.6	—	1.2	V	$V_{DS} = V_{GS}, I_D = 250\mu A$
g_{fs}	Forward Transconductance	14	—	—	S	$V_{DS} = 10V, I_D = 7.0A$
I_{DSS}	Drain-to-Source Leakage Current	—	—	1.0	μA	$V_{DS} = 16V, V_{GS} = 0V$
		—	—	25		$V_{DS} = 16V, V_{GS} = 0V, T_J = 70^\circ\text{C}$
I_{GSS}	Gate-to-Source Forward Leakage	—	—	100	nA	$V_{GS} = 12V$
	Gate-to-Source Reverse Leakage	—	—	-100		$V_{GS} = -12V$
Q_g	Total Gate Charge	—	13	20	nC	$I_D = 7.0A$
Q_{gs}	Gate-to-Source Charge	—	3.7	—		$V_{DS} = 10V$
Q_{gd}	Gate-to-Drain ("Miller") Charge	—	2.1	—		$V_{GS} = 4.5V$
$t_{d(on)}$	Turn-On Delay Time	—	7.6	—	ns	$V_{DD} = 10V$ ②
t_r	Rise Time	—	22	—		$I_D = 1.0A$
$t_{d(off)}$	Turn-Off Delay Time	—	110	—		$R_G = 53\Omega$
t_f	Fall Time	—	50	—		$V_{GS} = 4.5V$
C_{iss}	Input Capacitance	—	1340	—	pF	$V_{GS} = 0V$
C_{oss}	Output Capacitance	—	170	—		$V_{DS} = 16V$
C_{rss}	Reverse Transfer Capacitance	—	120	—		$f = 1.0\text{MHz}$

Source-Drain Ratings and Characteristics

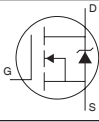
	Parameter	Min.	Typ.	Max.	Units	Conditions
I_S	Continuous Source Current (Body Diode)	—	—	2.0	A	MOSFET symbol showing the integral reverse p-n junction diode. 
I_{SM}	Pulsed Source Current (Body Diode) ①	—	—	28		
V_{SD}	Diode Forward Voltage	—	—	1.2	V	$T_J = 25^\circ\text{C}, I_S = 2.0A, V_{GS} = 0V$ ②
t_{rr}	Reverse Recovery Time	—	31	47	ns	$T_J = 25^\circ\text{C}, I_F = 2.0A$
Q_{rr}	Reverse Recovery Charge	—	15	23	nC	$di/dt = 100A/\mu s$ ②

Notes:

- ① Repetitive rating; pulse width limited by max. junction temperature.
- ② Pulse width $\leq 400\mu s$; duty cycle $\leq 2\%$.
- ③ Surface mounted on 1 in square Cu board

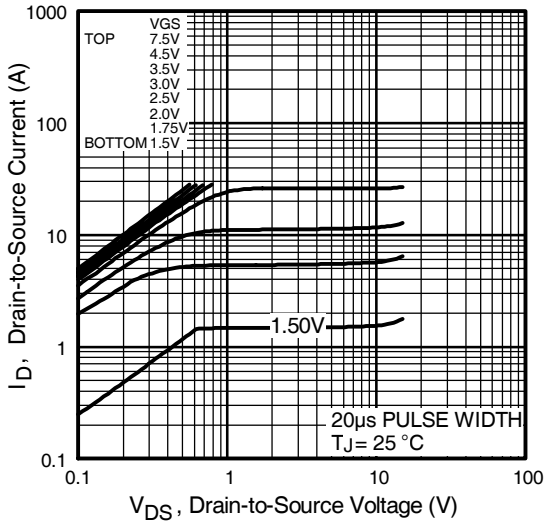

Fig 1. Typical Output Characteristics

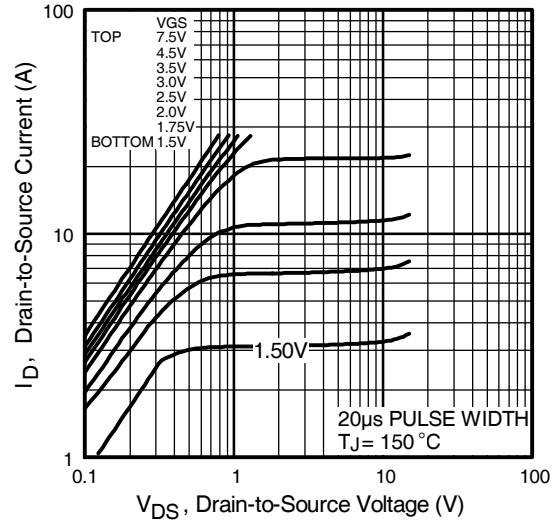

Fig 2. Typical Output Characteristics

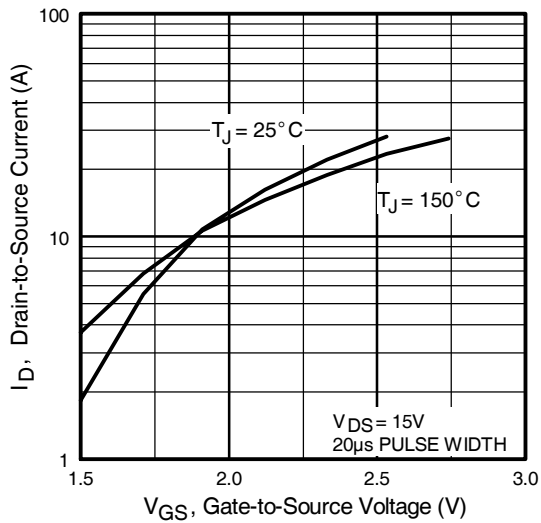

Fig 3. Typical Transfer Characteristics

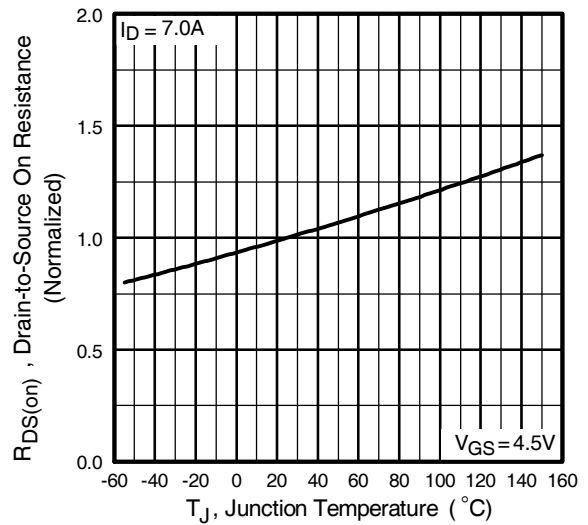

Fig 4. Normalized On-Resistance Vs. Temperature

IRF7331PbF

International
IR Rectifier

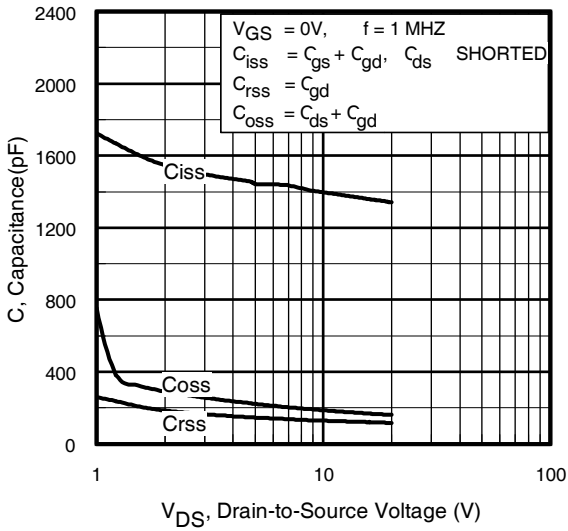

Fig 5. Typical Capacitance Vs. Drain-to-Source Voltage

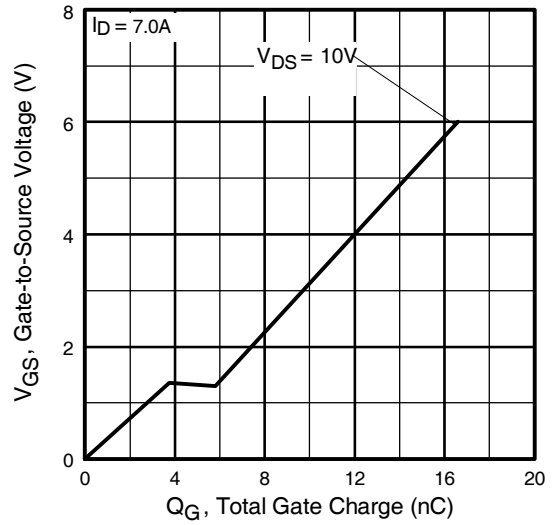

Fig 6. Typical Gate Charge Vs. Gate-to-Source Voltage

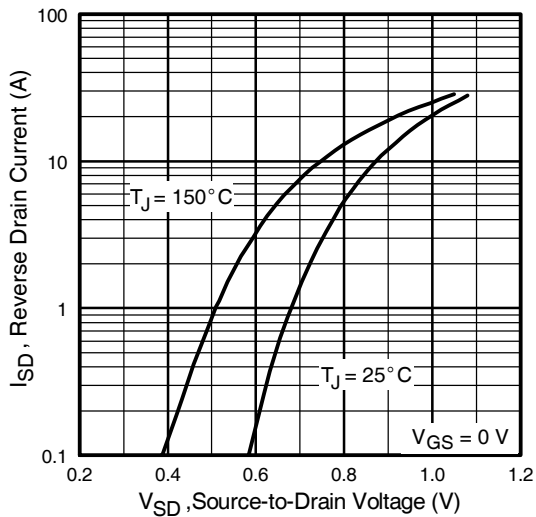

Fig 7. Typical Source-Drain Diode Forward Voltage

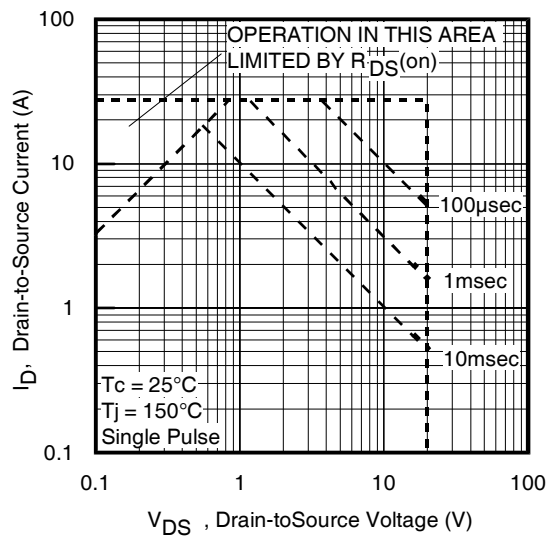

Fig 8. Maximum Safe Operating Area

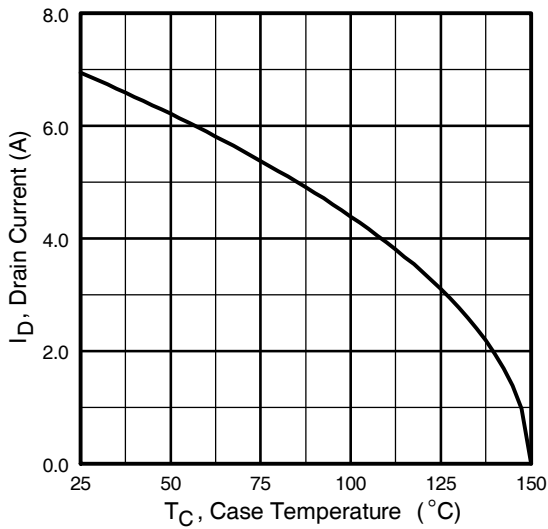

Fig 9. Maximum Drain Current Vs. Case Temperature

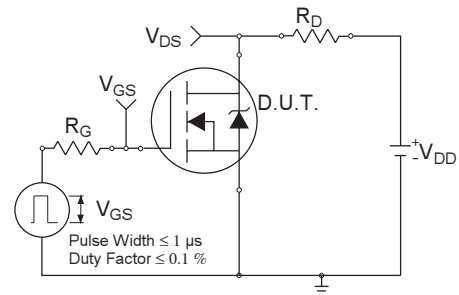

Fig 10a. Switching Time Test Circuit

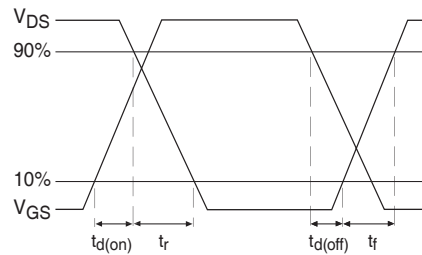

Fig 10b. Switching Time Waveforms

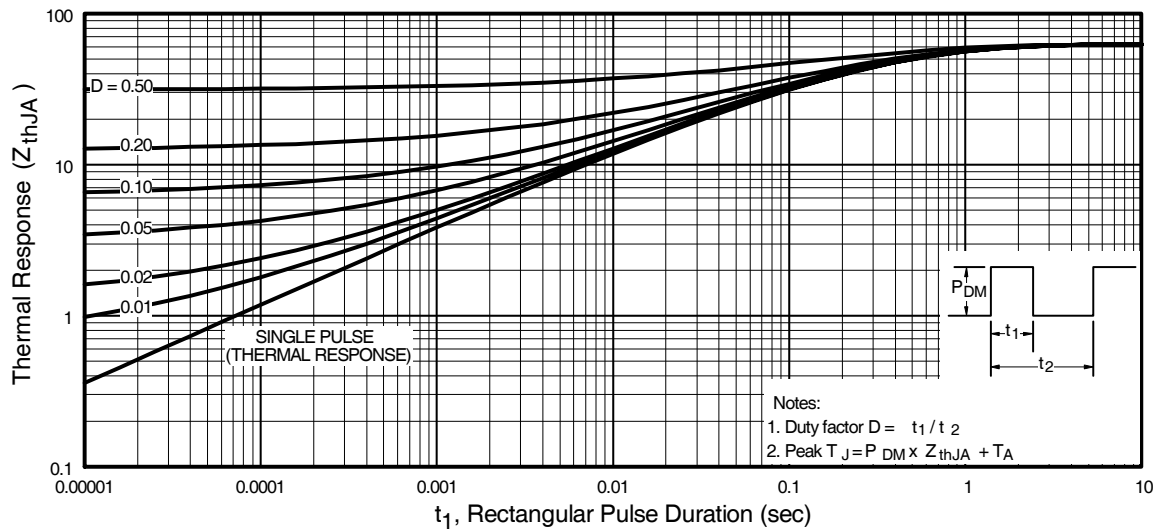

Fig 11. Maximum Effective Transient Thermal Impedance, Junction-to-Ambient

IRF7331PbF

International
IR Rectifier

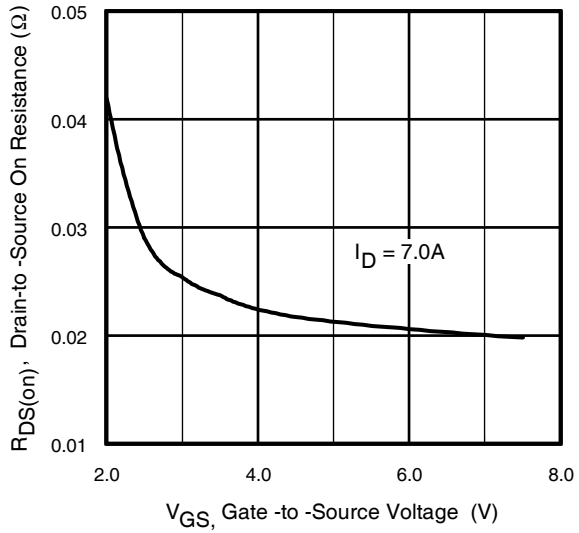

Fig 12. Typical On-Resistance Vs. Gate Voltage

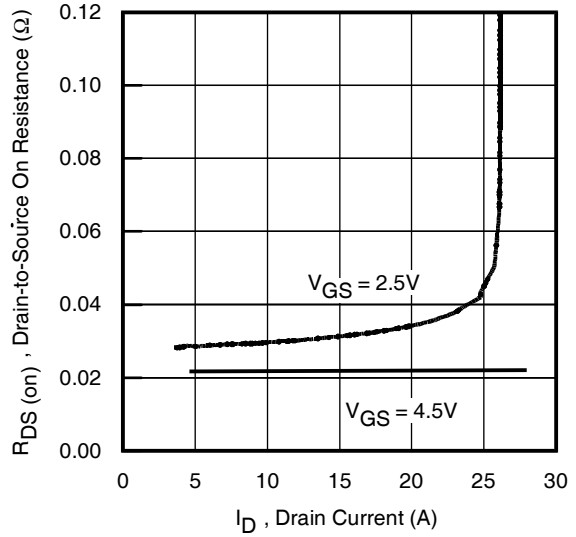

Fig 13. Typical On-Resistance Vs. Drain Current

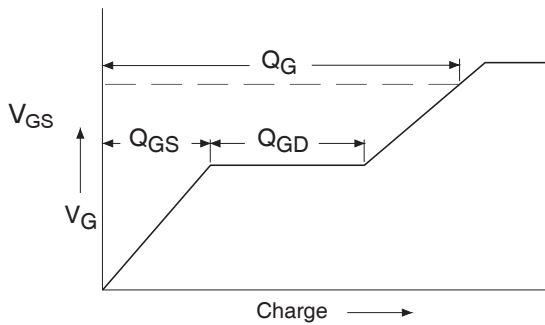

Fig 14a. Basic Gate Charge Waveform

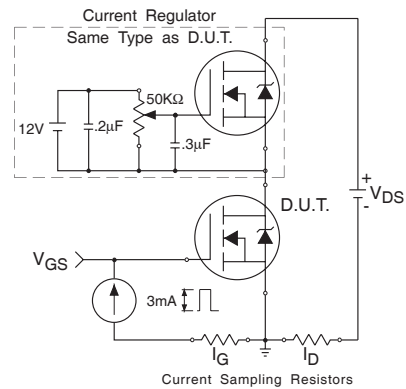

Fig 14b. Gate Charge Test Circuit

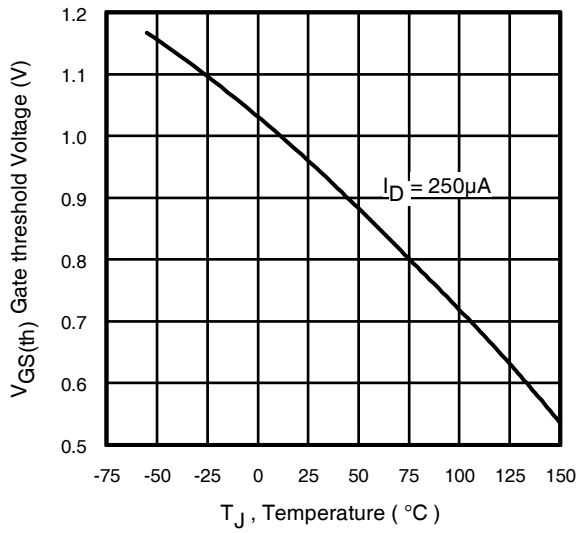

Fig 15. Typical $V_{GS(th)}$ Vs. Junction Temperature

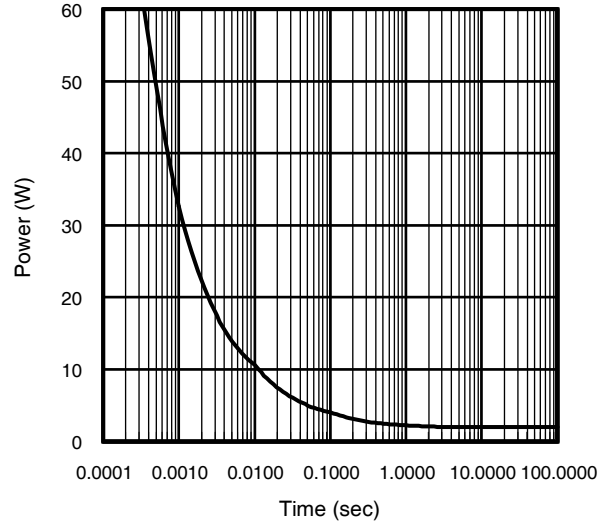
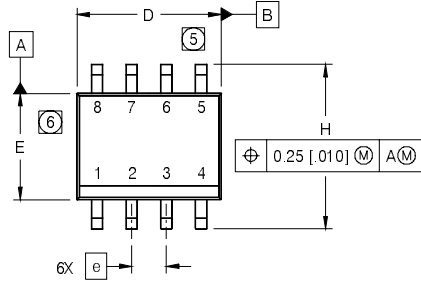

Fig 16. Typical Power Vs. Time

IRF7331PbF

SO-8 Package Outline (MOSFET & Fetky)

Dimensions are shown in millimeters (inches)



DIM	INCHES		MILLIMETERS	
	MIN	MAX	MIN	MAX
A	.0532	.0688	1.35	1.75
A1	.0040	.0098	0.10	0.25
b	.013	.020	0.33	0.51
c	.0075	.0098	0.19	0.25
D	.189	.1968	4.80	5.00
E	.1497	.1574	3.80	4.00
e	.050 BASIC		1.27 BASIC	
e1	.025 BASIC		0.635 BASIC	
H	.2284	.2440	5.80	6.20
K	.0099	.0196	0.25	0.50
L	.016	.050	0.40	1.27
y	0°	8°	0°	8°

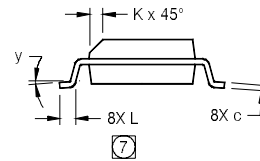
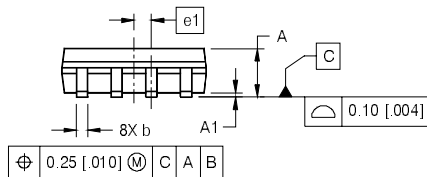

NOTES:

1. DIMENSIONING & TOLERANCING PER ASME Y14.5M-1994.
2. CONTROLLING DIMENSION: MILLIMETER
3. DIMENSIONS ARE SHOWN IN MILLIMETERS [INCHES].
4. OUTLINE CONFORMS TO JEDEC OUTLINE MS-012AA.
5. DIMENSION DOES NOT INCLUDE MOLD PROTRUSIONS. MOLD PROTRUSIONS NOT TO EXCEED 0.15 [0.006].
6. DIMENSION DOES NOT INCLUDE MOLD PROTRUSIONS. MOLD PROTRUSIONS NOT TO EXCEED 0.25 [0.010].
7. DIMENSION IS THE LENGTH OF LEAD FOR SOLDERING TO A SUBSTRATE.

FOOTPRINT

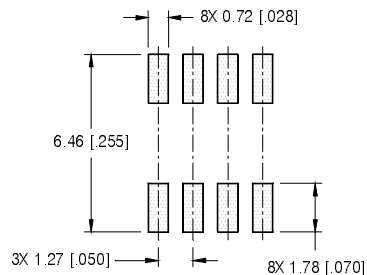

SO-8 Part Marking Information

EXAMPLE: THIS IS AN IRF7101 (MOSFET)

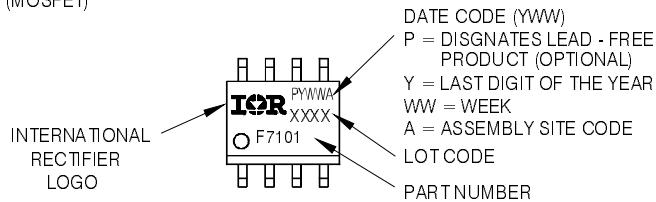

Note: For the most current drawing please refer to IR website at: <http://www.irf.com/package/>

SO-8 Tape and Reel

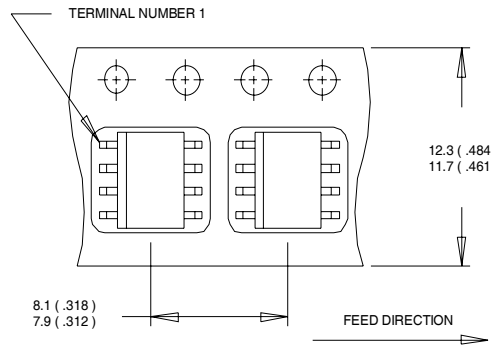

- NOTES:
1. CONTROLLING DIMENSION : MILLIMETER.
 2. ALL DIMENSIONS ARE SHOWN IN MILLIMETERS(INCHES).
 3. OUTLINE CONFORMS TO EIA-481 & EIA-541.

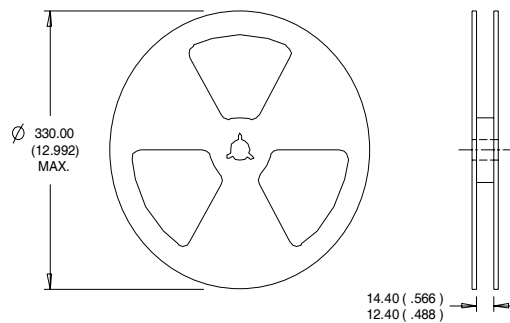

- NOTES :
1. CONTROLLING DIMENSION : MILLIMETER.
 2. OUTLINE CONFORMS TO EIA-481 & EIA-541.

Note: For the most current drawing please refer to IR website at: <http://www.irf.com/package/>

Data and specifications subject to change without notice.
 This product has been designed and qualified for the Consumer market.
 Qualification Standards can be found on IR's Web site.