

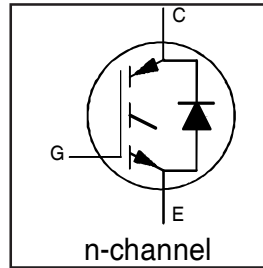
# IRG4RC10SD

INSULATED GATE BIPOLAR TRANSISTOR WITH  
 ULTRAFAST SOFT RECOVERY DIODE

Standard Speed CoPack  
 IGBT

### Features

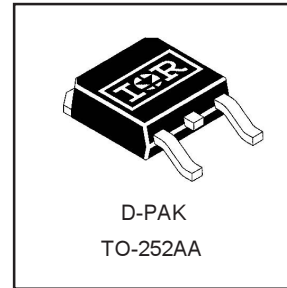
- Extremely low voltage drop 1.1V(typ) @ 2A
- S-Series: Minimizes power dissipation at up to 3 KHz PWM frequency in inverter drives, up to 4 KHz in brushless DC drives.
- Tight parameter distribution
- IGBT co-packaged with HEXFRED™ ultrafast, ultra-soft-recovery anti-parallel diodes for use in bridge configurations
- Industry standard TO-252AA package



$V_{CES} = 600V$
$V_{CE(on)} \text{ typ.} = 1.10V$
@ $V_{GE} = 15V, I_C = 2.0A$

### Benefits

- Generation 4 IGBT's offer highest efficiencies available
- IGBT's optimized for specific application conditions
- HEXFRED diodes optimized for performance with IGBT's . Minimized recovery characteristics require less/no snubbing
- Lower losses than MOSFET's conduction and Diode losses



### Absolute Maximum Ratings

	Parameter	Max.	Units
$V_{CES}$	Collector-to-Emitter Voltage	600	V
$I_C @ T_C = 25^\circ C$	Continuous Collector Current	14	A
$I_C @ T_C = 100^\circ C$	Continuous Collector Current	8.0	
$I_{CM}$	Pulsed Collector Current ①	18	
$I_{LM}$	Clamped Inductive Load Current ②	18	
$I_F @ T_C = 100^\circ C$	Diode Continuous Forward Current	4.0	
$I_{FM}$	Diode Maximum Forward Current	16	
$V_{GE}$	Gate-to-Emitter Voltage	$\pm 20$	V
$P_D @ T_C = 25^\circ C$	Maximum Power Dissipation	38	W
$P_D @ T_C = 100^\circ C$	Maximum Power Dissipation	15	
$T_J$	Operating Junction and	-55 to +150	°C
$T_{STG}$	Storage Temperature Range		

### Thermal Resistance

	Parameter	Typ.	Max.	Units
$R_{\theta JC}$	Junction-to-Case - IGBT	—	3.3	°C/W
$R_{\theta JC}$	Junction-to-Case - Diode	—	7.0	
$R_{\theta JA}$	Junction-to-Ambient (PCB mount)*	—	50	
Wt	Weight	0.3 (0.01)	—	g (oz)

\* When mounted on 1" square PCB (FR-4 or G-10 Material).  
 For recommended footprint and soldering techniques refer to application note #AN-994

# IRG4RC10SD

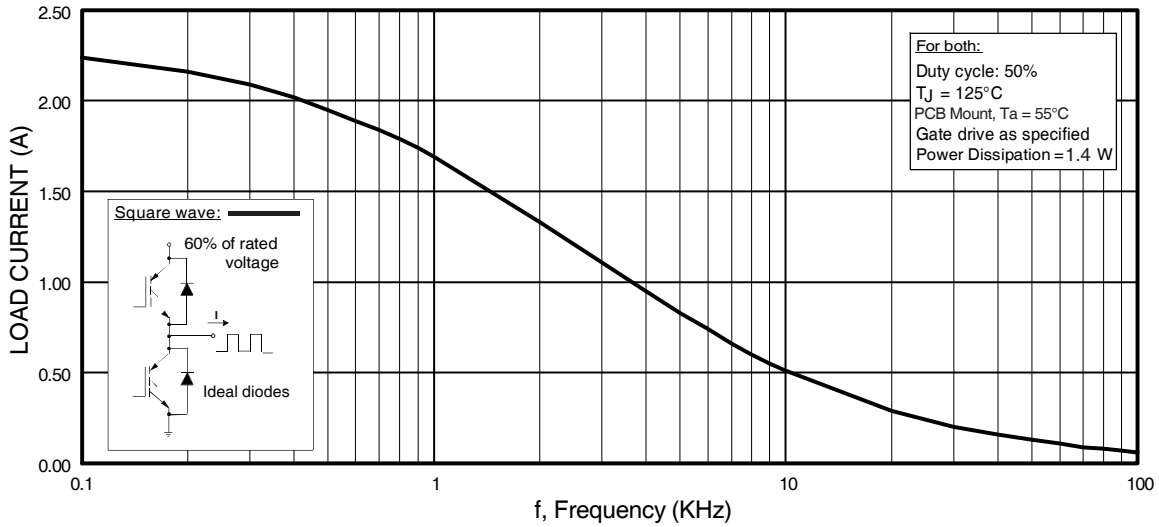
## Electrical Characteristics @ T<sub>J</sub> = 25°C (unless otherwise specified)

	Parameter	Min.	Typ.	Max.	Units	Conditions
V <sub>(BR)CES</sub>	Collector-to-Emitter Breakdown Voltage <sup>③</sup>	600	—	—	V	V <sub>GE</sub> = 0V, I <sub>C</sub> = 250μA
ΔV <sub>(BR)CES</sub> /ΔT <sub>J</sub>	Temperature Coeff. of Breakdown Voltage	—	0.64	—	V/°C	V <sub>GE</sub> = 0V, I <sub>C</sub> = 1.0mA
V <sub>CE(on)</sub>	Collector-to-Emitter Saturation Voltage	—	1.58	1.8	V	V <sub>GE</sub> = 15V See Fig. 2, 5
		—	2.05	—		
		—	1.68	—		
V <sub>GE(th)</sub>	Gate Threshold Voltage	3.0	—	6.0		V <sub>CE</sub> = V <sub>GE</sub> , I <sub>C</sub> = 250μA
ΔV <sub>GE(th)</sub> /ΔT <sub>J</sub>	Temperature Coeff. of Threshold Voltage	—	-9.5	—	mV/°C	V <sub>CE</sub> = V <sub>GE</sub> , I <sub>C</sub> = 250μA
g <sub>fe</sub>	Forward Transconductance <sup>④</sup>	3.65	5.48	—	S	V <sub>CE</sub> = 100V, I <sub>C</sub> = 8.0A
I <sub>CES</sub>	Zero Gate Voltage Collector Current	—	—	250	μA	V <sub>GE</sub> = 0V, V <sub>CE</sub> = 600V V <sub>GE</sub> = 0V, V <sub>CE</sub> = 600V, T <sub>J</sub> = 150°C
		—	—	1000		
V <sub>FM</sub>	Diode Forward Voltage Drop	—	1.5	1.8	V	I <sub>C</sub> = 4.0A See Fig. 13 I <sub>C</sub> = 4.0A, T <sub>J</sub> = 150°C
		—	1.4	1.7		
I <sub>GES</sub>	Gate-to-Emitter Leakage Current	—	—	±100	nA	V <sub>GE</sub> = ±20V

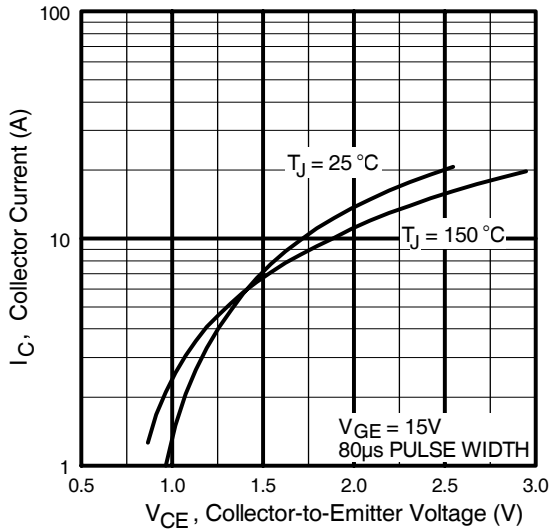
## Switching Characteristics @ T<sub>J</sub> = 25°C (unless otherwise specified)

	Parameter	Min.	Typ.	Max.	Units	Conditions		
Q <sub>g</sub>	Total Gate Charge (turn-on)	—	15	22	nC	I <sub>C</sub> = 8.0A V <sub>CC</sub> = 400V See Fig. 8 V <sub>GE</sub> = 15V		
Q <sub>ge</sub>	Gate - Emitter Charge (turn-on)	—	2.42	3.6				
Q <sub>gc</sub>	Gate - Collector Charge (turn-on)	—	6.53	9.8				
t <sub>d(on)</sub>	Turn-On Delay Time	—	76	—	ns	T <sub>J</sub> = 25°C I <sub>C</sub> = 8.0A, V <sub>CC</sub> = 480V V <sub>GE</sub> = 15V, R <sub>G</sub> = 100Ω Energy losses include "tail" and diode reverse recovery. See Fig. 9, 10, 18		
t <sub>r</sub>	Rise Time	—	32	—				
t <sub>d(off)</sub>	Turn-Off Delay Time	—	815	1200				
t <sub>f</sub>	Fall Time	—	720	1080				
E <sub>on</sub>	Turn-On Switching Loss	—	0.31	—				
E <sub>off</sub>	Turn-Off Switching Loss	—	3.28	—				
E <sub>ts</sub>	Total Switching Loss	—	3.60	10.9				
E <sub>ts</sub>	Total Switching Loss	—	1.46	2.6				
t <sub>d(on)</sub>	Turn-On Delay Time	—	70	—			mJ	I <sub>C</sub> = 5.0A T <sub>J</sub> = 150°C, See Fig. 10,11, 18 I <sub>C</sub> = 8.0A, V <sub>CC</sub> = 480V V <sub>GE</sub> = 15V, R <sub>G</sub> = 100Ω Energy losses include "tail" and diode reverse recovery.
t <sub>r</sub>	Rise Time	—	36	—				
t <sub>d(off)</sub>	Turn-Off Delay Time	—	890	—				
t <sub>f</sub>	Fall Time	—	890	—				
E <sub>ts</sub>	Total Switching Loss	—	3.83	—				
L <sub>E</sub>	Internal Emitter Inductance	—	7.5	—	nH	Measured 5mm from package		
C <sub>ies</sub>	Input Capacitance	—	280	—	pF	V <sub>GE</sub> = 0V V <sub>CC</sub> = 30V See Fig. 7 f = 1.0MHz		
C <sub>oes</sub>	Output Capacitance	—	30	—				
C <sub>res</sub>	Reverse Transfer Capacitance	—	4.0	—				
t <sub>rr</sub>	Diode Reverse Recovery Time	—	28	42				
I <sub>rr</sub>	Diode Peak Reverse Recovery Current	—	38	57	A	T <sub>J</sub> = 25°C See Fig. 14 T <sub>J</sub> = 125°C 15 I <sub>F</sub> = 4.0A V <sub>R</sub> = 200V		
		—	3.7	6.7				
Q <sub>rr</sub>	Diode Reverse Recovery Charge	—	40	60	nC	T <sub>J</sub> = 25°C See Fig. 16 T <sub>J</sub> = 125°C 16 di/dt = 200A/μs		
		—	70	105				
di <sub>(rec)M</sub> /dt	Diode Peak Rate of Fall of Recovery During t <sub>b</sub>	—	280	—	A/μs	T <sub>J</sub> = 25°C See Fig. 17 T <sub>J</sub> = 125°C 17		
		—	235	—				

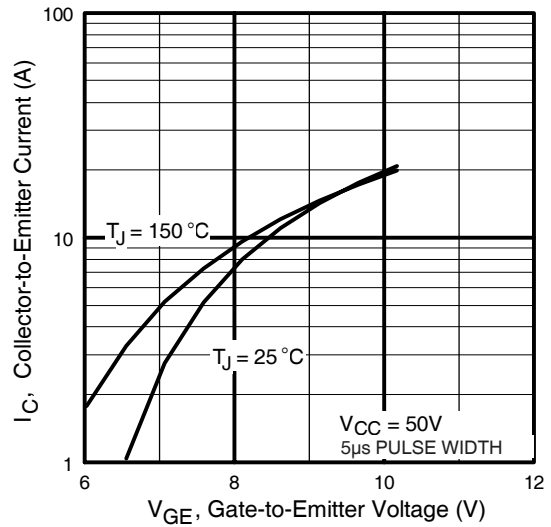
Details of note ① through ④ are on the last page



**Fig. 1 - Typical Load Current vs. Frequency**  
(Load Current =  $I_{RMS}$  of fundamental)

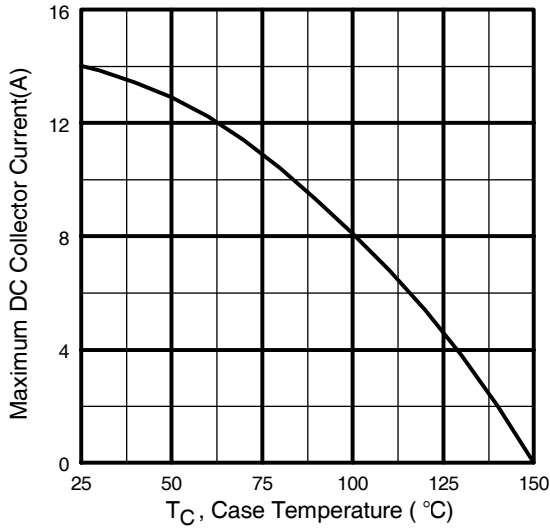


**Fig. 2 - Typical Output Characteristics**

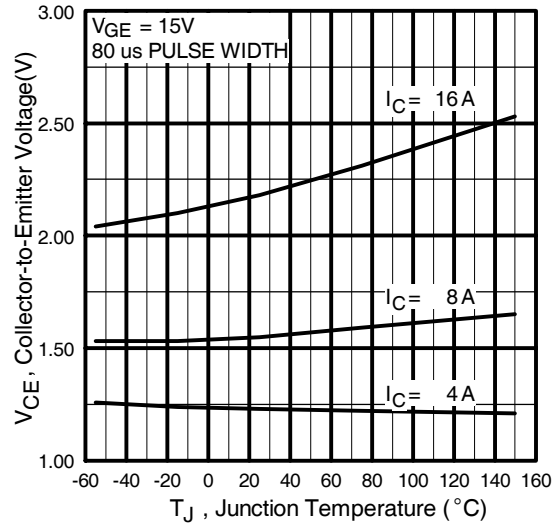


**Fig. 3 - Typical Transfer Characteristics**

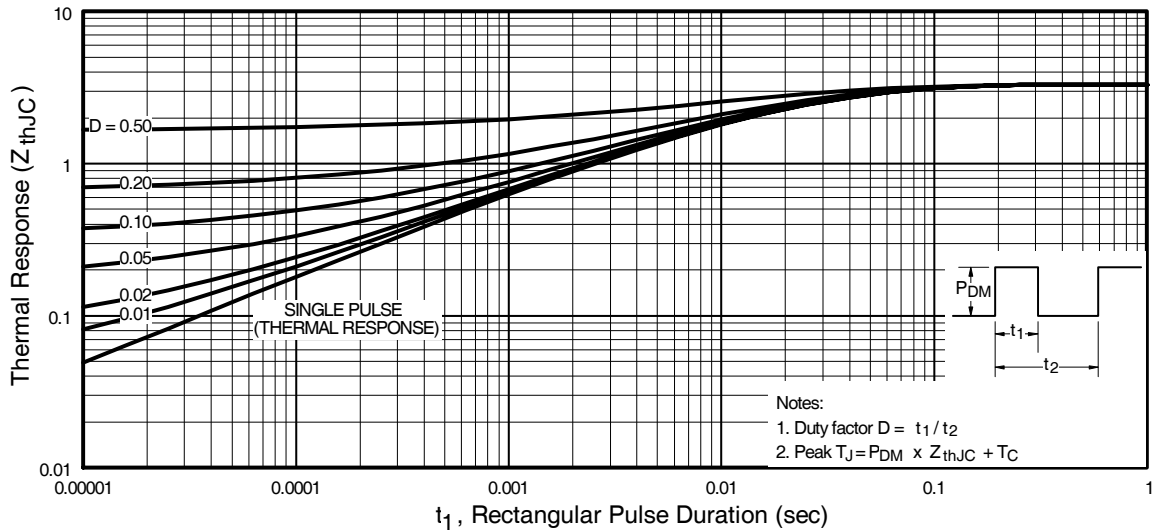
# IRG4RC10SD



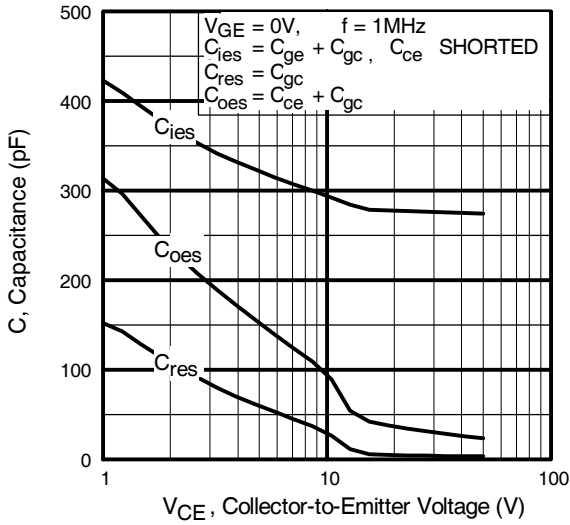
**Fig. 4** - Maximum Collector Current vs. Case Temperature



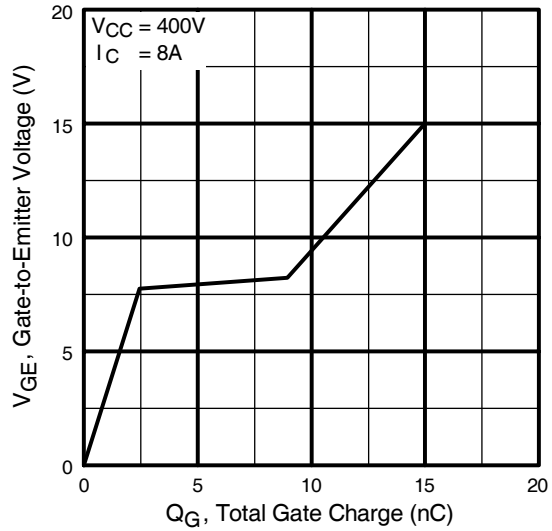
**Fig. 5** - Typical Collector-to-Emitter Voltage vs. Junction Temperature



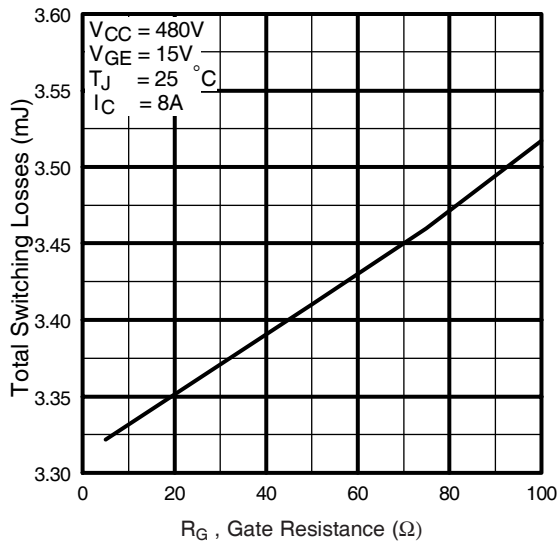
**Fig. 6** - Maximum Effective Transient Thermal Impedance, Junction-to-Case



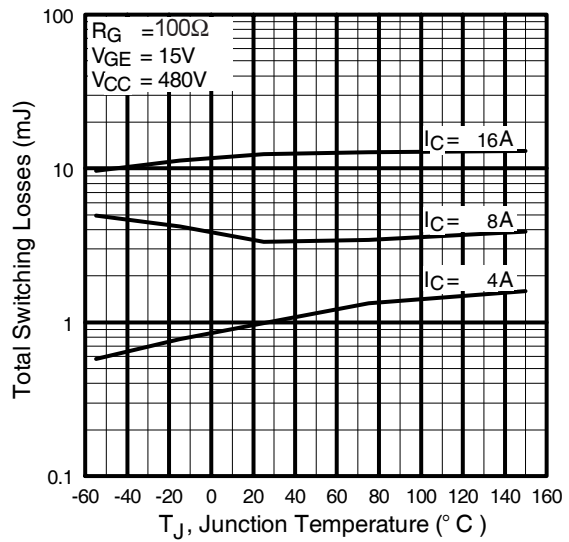
**Fig. 7** - Typical Capacitance vs. Collector-to-Emitter Voltage



**Fig. 8** - Typical Gate Charge vs. Gate-to-Emitter Voltage

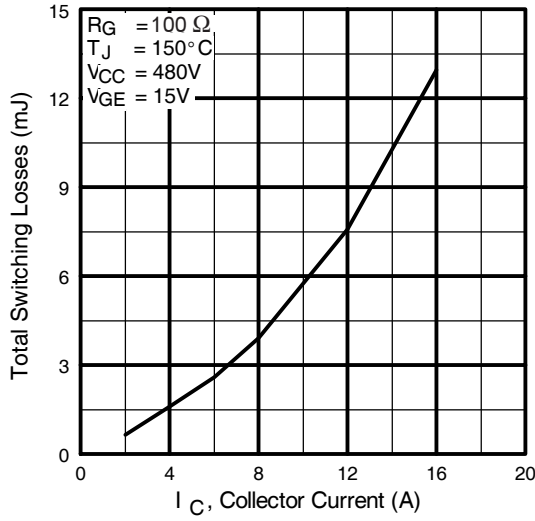


**Fig. 9** - Typical Switching Losses vs. Gate Resistance

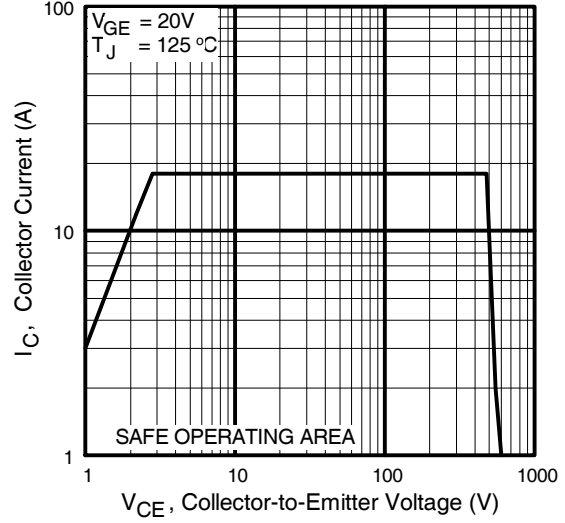


**Fig. 10** - Typical Switching Losses vs. Junction Temperature

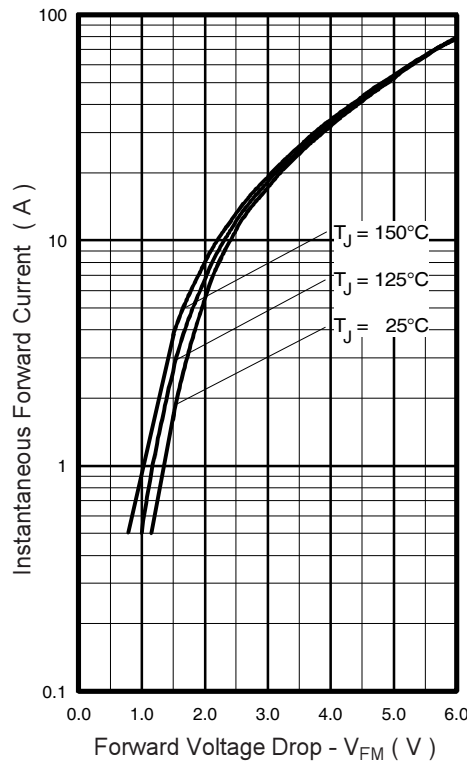
# IRG4RC10SD



**Fig. 11** - Typical Switching Losses vs. Collector Current



**Fig. 12** - Turn-Off SOA



**Fig. 13** - Maximum Forward Voltage Drop vs. Instantaneous Forward Current

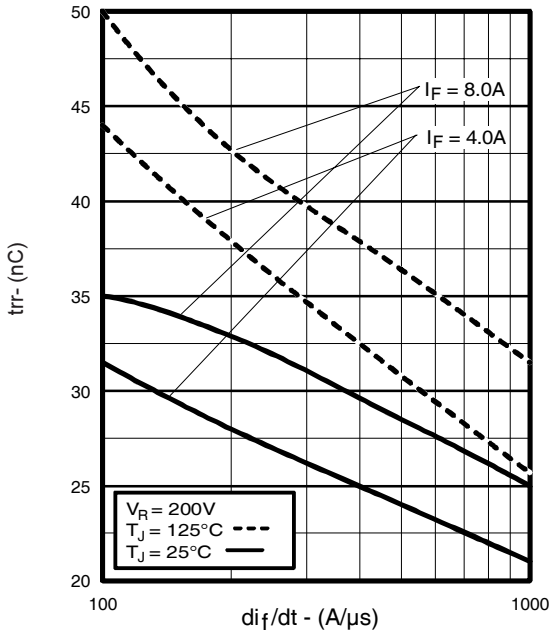


Fig. 14 - Typical Reverse Recovery vs.  $di_f/dt$

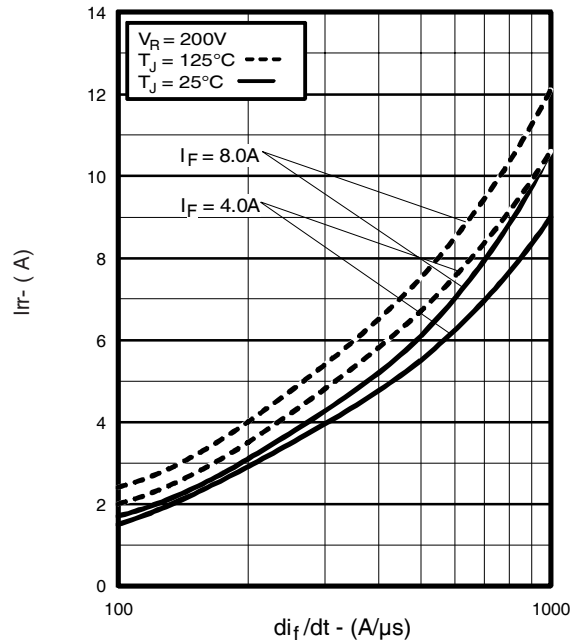


Fig. 15 - Typical Recovery Current vs.  $di_f/dt$

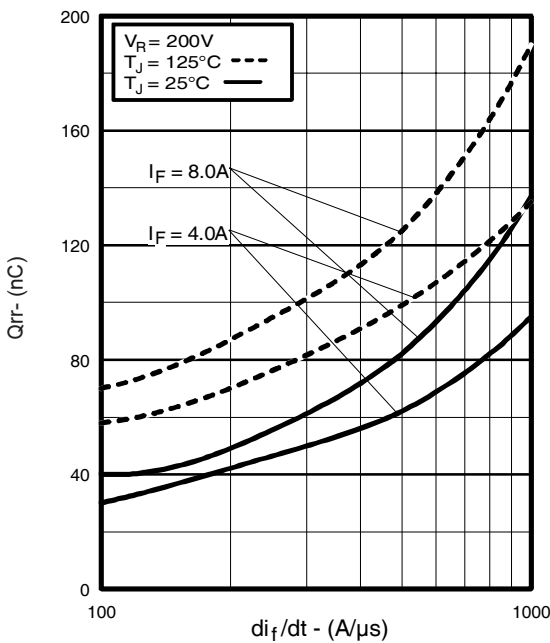


Fig. 16 - Typical Stored Charge vs.  $di_f/dt$

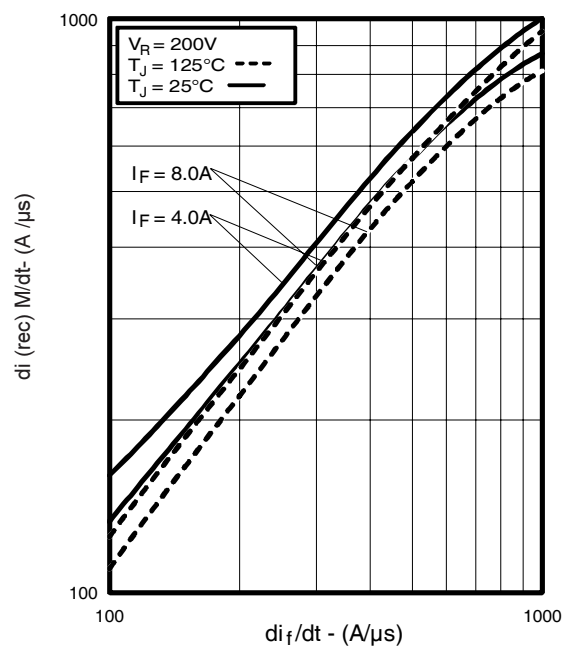
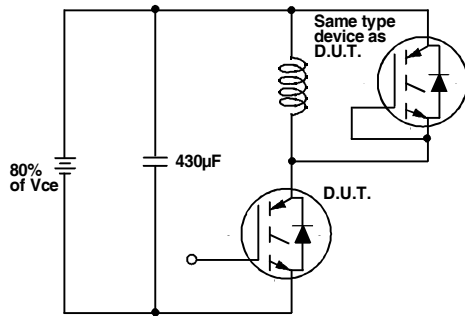
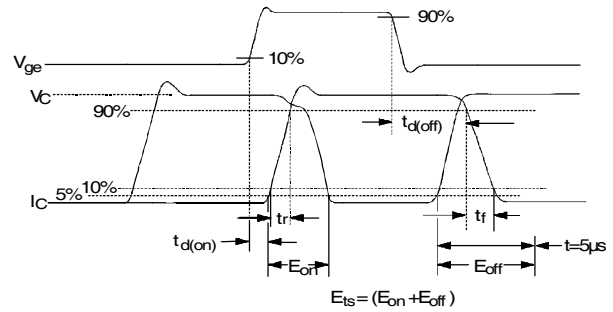


Fig. 17 - Typical  $di_{(rec)M}/dt$  vs.  $di_f/dt$

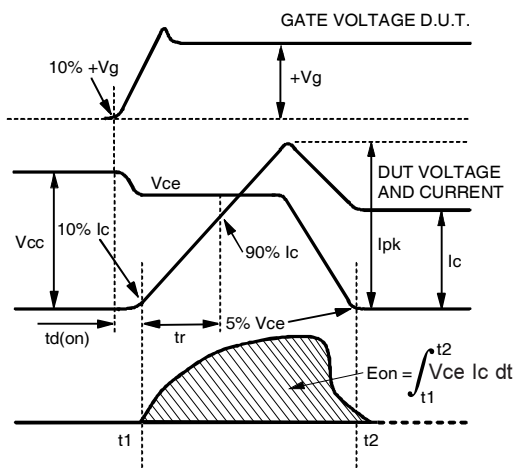
# IRG4RC10SD



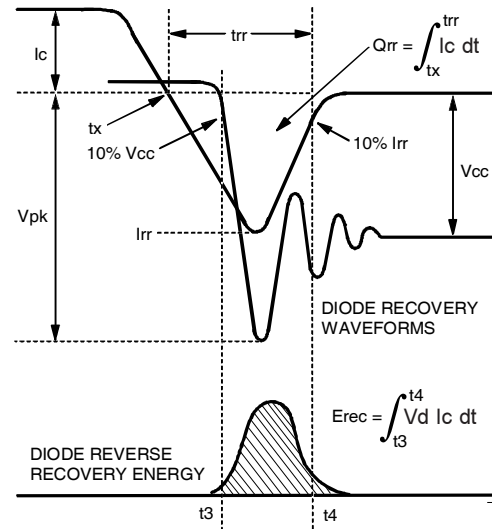
**Fig. 18a** - Test Circuit for Measurement of  $I_{LM}$ ,  $E_{on}$ ,  $E_{off}(\text{diode})$ ,  $t_{rr}$ ,  $Q_{rr}$ ,  $I_{rr}$ ,  $t_{d(on)}$ ,  $t_r$ ,  $t_{d(off)}$ ,  $t_f$



**Fig. 18b** - Test Waveforms for Circuit of Fig. 18a, Defining  $E_{off}$ ,  $t_{d(off)}$ ,  $t_f$



**Fig. 18c** - Test Waveforms for Circuit of Fig. 18a, Defining  $E_{on}$ ,  $t_{d(on)}$ ,  $t_r$



**Fig. 18d** - Test Waveforms for Circuit of Fig. 18a, Defining  $E_{rec}$ ,  $t_{rr}$ ,  $Q_{rr}$ ,  $I_{rr}$



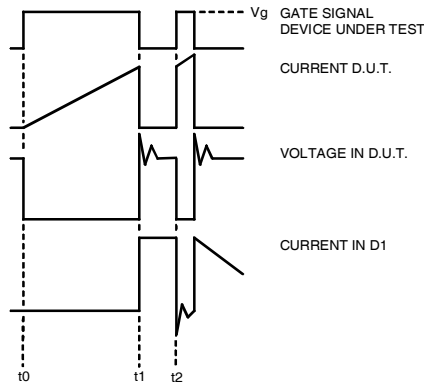


Figure 18e. Macro Waveforms for Figure 18a's Test Circuit

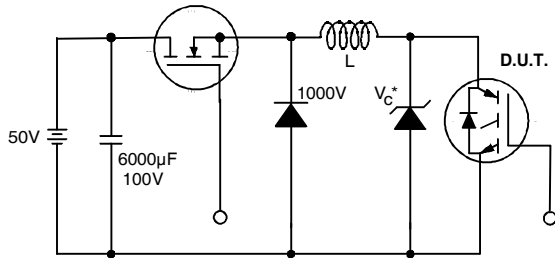


Figure 19. Clamped Inductive Load Test Circuit

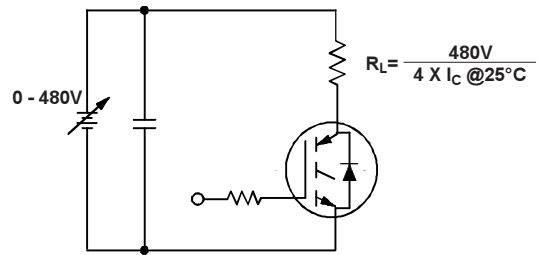
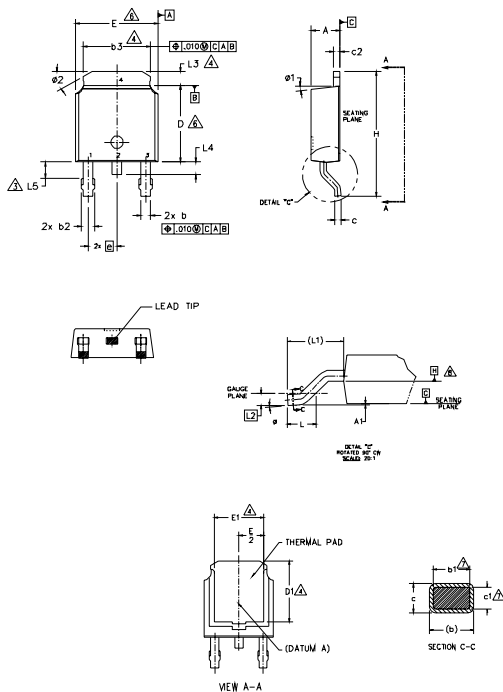


Figure 20. Pulsed Collector Current Test Circuit

# IRG4RC10SD

## D-Pak (TO-252AA) Package Outline

Dimensions are shown in millimeters (inches)



- NOTES:
- 1.- DIMENSIONING AND TOLERANCING PER ASME Y14.5M-1994
  - 2.- DIMENSION ARE SHOWN IN INCHES [MILLIMETERS]
  - 3.- LEAD DIMENSION UNCONTROLLED IN L5.
  - 4.- DIMENSION D1, E1, L3 & b3 ESTABLISH A MINIMUM MOUNTING SURFACE FOR THERMAL PAD.
  - 5.- SECTION C-C DIMENSIONS APPLY TO THE FLAT SECTION OF THE LEAD BETWEEN .005 AND 0.10 [0.13 AND 0.25] FROM THE LEAD TIP.
  - 6.- DIMENSION D & E DO NOT INCLUDE MOLD FLASH. MOLD FLASH SHALL NOT EXCEED .005 [0.13] PER SIDE. THESE DIMENSIONS ARE MEASURED AT THE OUTMOST EXTREMES OF THE PLASTIC BODY.
  - 7.- DIMENSION b1 & c1 APPLIED TO BASE METAL ONLY.
  - 8.- DATUM A & B TO BE DETERMINED AT DATUM PLANE H.
  - 9.- OUTLINE CONFORMS TO JEDEC OUTLINE TO-252AA.

SYMBOL	DIMENSIONS				NOTES
	MILLIMETERS		INCHES		
	MIN.	MAX.	MIN.	MAX.	
A	2.18	2.39	.086	.094	
A1	-	0.13	-	.005	
b	0.64	0.89	.025	.035	
b1	0.65	0.79	.025	.031	7
b2	0.76	1.14	.030	.045	
b3	4.95	5.46	.195	.215	4
c	0.46	0.61	.018	.024	
c1	0.41	0.56	.016	.022	7
c2	0.46	0.89	.018	.035	
D	5.97	6.22	.235	.245	6
D1	5.21	-	.205	-	4
E	6.35	6.73	.250	.265	6
E1	4.32	-	.170	-	4
ø	2.29 BSC		.090 BSC		
H	9.40	10.41	.370	.410	
L	1.40	1.78	.055	.070	
L1	2.74 BSC		.108 REF.		
L2	0.51 BSC		.020 BSC		
L3	0.89	1.27	.035	.050	4
L4	-	1.02	-	.040	
L5	1.14	1.52	.045	.060	3
ø	0"	10"	0"	10"	
ø1	0"	15"	0"	15"	
ø2	25"	35"	25"	35"	

### LEAD ASSIGNMENTS

### HEXFEE

- 1.- GATE
- 2.- DRAIN
- 3.- SOURCE
- 4.- DRAIN

### IGBT & CoPAK

- 1.- GATE
- 2.- COLLECTOR
- 3.- EMITTER
- 4.- COLLECTOR

## D-Pak (TO-252AA) Part Marking Information

EXAMPLE: THIS IS AN IRFR120  
WITH ASSEMBLY  
LOT CODE 1234  
ASSEMBLED ON WW 16, 2001  
IN THE ASSEMBLY LINE 'A'

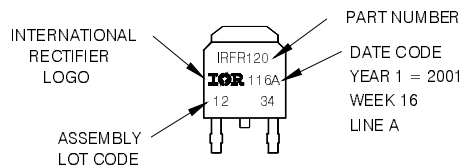
Note: 'P' in assembly line position  
indicates 'Lead-Free'

'P' in assembly line position indicates  
'Lead-Free' qualification to the consumer-level

OR

INTERNATIONAL  
RECTIFIER  
LOGO

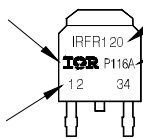
ASSEMBLY  
LOT CODE



PART NUMBER  
DATE CODE  
YEAR 1 = 2001  
WEEK 16  
LINE A

INTERNATIONAL  
RECTIFIER  
LOGO

ASSEMBLY  
LOT CODE



PART NUMBER

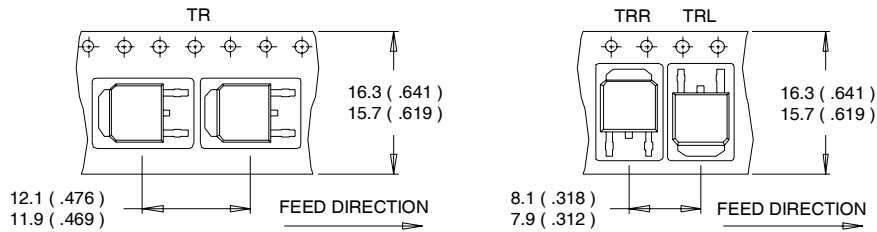
DATE CODE  
P = DESIGNATES LEAD-FREE  
PRODUCT (OPTIONAL)  
P̄ = DESIGNATES LEAD-FREE  
PRODUCT QUALIFIED TO THE  
CONSUMER LEVEL (OPTIONAL)

YEAR 1 = 2001  
WEEK 16  
A = ASSEMBLY SITE CODE

Note: For the most current drawing please refer to IR website at <http://www.irf.com/package/>

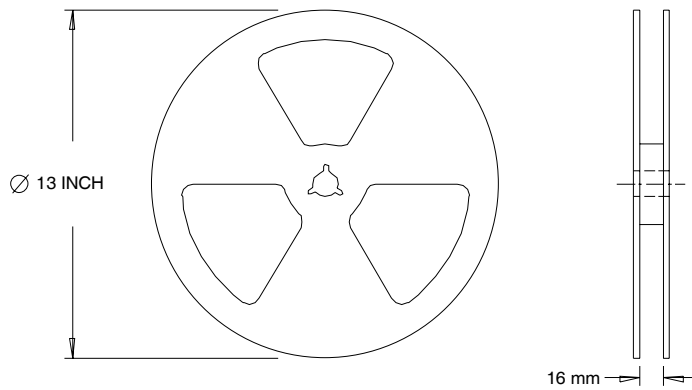
## D-Pak (TO-252AA) Tape & Reel Information

Dimensions are shown in millimeters (inches)



**NOTES :**

1. CONTROLLING DIMENSION : MILLIMETER.
2. ALL DIMENSIONS ARE SHOWN IN MILLIMETERS ( INCHES ).
3. OUTLINE CONFORMS TO EIA-481 & EIA-541.



**NOTES :**

1. OUTLINE CONFORMS TO EIA-481.

**Note:** For the most current drawing please refer to IR website at <http://www.irf.com/package/>

**Notes:**

- ① Repetitive rating:  $V_{GE}=20V$ ; pulse width limited by maximum junction temperature (figure 20)
- ②  $V_{CC}=80\%(V_{CES})$ ,  $V_{GE}=20V$ ,  $L=10\mu H$ ,  $R_G = 100W$  (figure 19)
- ③ Pulse width  $\leq 80\mu s$ ; duty factor  $\leq 0.1\%$ .
- ④ Pulse width  $5.0\mu s$ , single shot.

Data and specifications subject to change without notice.