

HiPerFAST™ IGBT IXGH 32N60BU1 with Diode

$V_{CES} = 600 \text{ V}$
 $I_{C25} = 60 \text{ A}$
 $V_{CE(sat)} = 2.3 \text{ V}$
 $t_{fi} = 80 \text{ ns}$

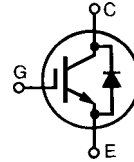

Symbol	Test Conditions	Maximum Ratings	
V_{CES}	$T_J = 25^\circ\text{C}$ to 150°C	600	V
V_{CGR}	$T_J = 25^\circ\text{C}$ to 150°C ; $R_{GE} = 1 \text{ M}\Omega$	600	V
V_{GES}	Continuous	± 20	V
V_{GEM}	Transient	± 30	V
I_{C25}	$T_C = 25^\circ\text{C}$	60	A
I_{C90}	$T_C = 90^\circ\text{C}$	32	A
I_{CM}	$T_C = 25^\circ\text{C}$, 1 ms	120	A
SSOA (RBSOA)	$V_{GE} = 15 \text{ V}$, $T_{VJ} = 125^\circ\text{C}$, $R_G = 33 \Omega$ Clamped inductive load, $L = 100 \mu\text{H}$	$I_{CM} = 64$ @ $0.8 V_{CES}$	A
P_C	$T_C = 25^\circ\text{C}$	200	W
T_J		-55 ... +150	$^\circ\text{C}$
T_{JM}		150	$^\circ\text{C}$
T_{stg}		-55 ... +150	$^\circ\text{C}$
Maximum Lead and Tab temperature for soldering 1.6 mm (0.062 in.) from case for 10 s		300	$^\circ\text{C}$
M_d	Mounting torque, TO-247 AD	1.13/10	Nm/lb.in.
Weight		6	g

TO-247 AD

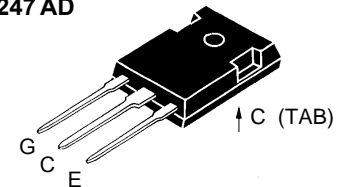

G = Gate, C = Collector,
 E = Emitter, TAB = Collector

Features

- International standard packages
JEDEC TO-247 SMD
- High frequency IGBT and antiparallel
FRED in one package
- High current handling capability
- Newest generation HDMOS™ process
- MOS Gate turn-on
- drive simplicity

Applications

- AC motor speed control
- DC servo and robot drives
- DC choppers
- Uninterruptible power supplies (UPS)
- Switched-mode and resonant-mode
power supplies

Advantages

- Space savings (two devices in one
package)
- High power density
- Very fast switching speeds for high
frequency applications

Symbol	Test Conditions	Characteristic Values ($T_J = 25^\circ\text{C}$, unless otherwise specified)		
		min.	typ.	max.
BV_{CES}	$I_C = 750 \mu\text{A}$, $V_{GE} = 0 \text{ V}$	600		V
$V_{GE(th)}$	$I_C = 250 \mu\text{A}$, $V_{CE} = V_{GE}$	2.5		V
I_{CES}	$V_{CE} = 0.8 \cdot V_{CES}$, $T_J = 25^\circ\text{C}$ $V_{GE} = 0 \text{ V}$, $T_J = 125^\circ\text{C}$			500 μA 8 mA
I_{GES}	$V_{CE} = 0 \text{ V}$, $V_{GE} = \pm 20 \text{ V}$			$\pm 100 \text{ nA}$
$V_{CE(sat)}$	$I_C = I_{C90}$, $V_{GE} = 15 \text{ V}$			2.3 V

Symbol	Test Conditions	Characteristic Values ($T_J = 25^\circ\text{C}$, unless otherwise specified)		
		min.	typ.	max.
g_{fs}	$I_C = I_{C90}$; $V_{CE} = 10\text{ V}$, Pulse test, $t \leq 300\ \mu\text{s}$, duty cycle $\leq 2\%$	15	25	S
C_{ies}	$V_{CE} = 25\text{ V}$, $V_{GE} = 0\text{ V}$, $f = 1\text{ MHz}$		2700	pF
C_{oes}			270	pF
C_{res}			50	pF
Q_G	$I_C = I_{C90}$, $V_{GE} = 15\text{ V}$, $V_{CE} = 0.5\text{ V}_{CES}$		110	150 nC
Q_{GE}			23	35 nC
Q_{GC}			40	75 nC
$t_{d(on)}$	Inductive load, $T_J = 25^\circ\text{C}$ $I_C = I_{C90}$, $V_{GE} = 15\text{ V}$, $L = 100\ \mu\text{H}$, $V_{CE} = 0.8\text{ V}_{CES}$, $R_G = R_{off} = 4.7\ \Omega$ Remarks: Switching times may increase for V_{CE} (Clamp) $> 0.8 \cdot V_{CES}$, higher T_J or increased R_G		25	ns
t_{ri}			20	ns
$t_{d(off)}$			100	200 ns
t_{fi}			80	150 ns
E_{off}			0.6	1.2 mJ
$t_{d(on)}$	Inductive load, $T_J = 125^\circ\text{C}$ $I_C = I_{C90}$, $V_{GE} = 15\text{ V}$, $L = 100\ \mu\text{H}$, $V_{CE} = 0.8\text{ V}_{CES}$, $R_G = R_{off} = 4.7\ \Omega$ Remarks: Switching times may increase for V_{CE} (Clamp) $> 0.8 \cdot V_{CES}$, higher T_J or increased R_G		25	ns
t_{ri}			25	ns
E_{on}			1	mJ
$t_{d(off)}$			120	ns
t_{fi}			120	ns
E_{off}		1.2	mJ	
R_{thJC}				0.62 K/W
R_{thCK}		0.25		K/W

TO-247 AD Outline

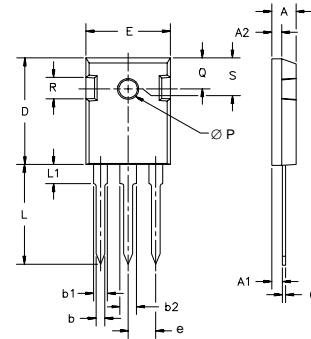

Dim.	Millimeter		Inches	
	Min.	Max.	Min.	Max.
A	4.7	5.3	.185	.209
A ₁	2.2	2.54	.087	.102
A ₂	2.2	2.6	.087	.102
b	1.0	1.4	.040	.055
b ₁	1.65	2.13	.065	.084
b ₂	2.87	3.12	.113	.123
C	.4	.8	.016	.031
D	20.80	21.46	.819	.845
E	15.75	16.26	.610	.640
e	5.20	5.72	0.205	0.225
L	19.81	20.32	.780	.800
L ₁		4.50		.177
∅P	3.55	3.65	.140	.144
Q	5.89	6.40	0.232	0.252
R	4.32	5.49	.170	.216
S	6.15	BSC	.242	BSC

Symbol	Test Conditions	Characteristic Values ($T_J = 25^\circ\text{C}$, unless otherwise specified)		
		min.	typ.	max.
V_F	$I_F = I_{C90}$, $V_{GE} = 0\text{ V}$, Pulse test, $t \leq 300\ \mu\text{s}$, duty cycle $d \leq 2\%$			1.6 V
I_{RM}	$I_F = I_{C90}$, $V_{GE} = 0\text{ V}$, $-di_F/dt = 240\text{ A}/\mu\text{s}$ $V_R = 360\text{ V}$ $T_J = 125^\circ\text{C}$ $I_F = 1\text{ A}$; $-di/dt = 100\text{ A}/\mu\text{s}$; $V_R = 30\text{ V}$ $T_J = 25^\circ\text{C}$		10	15 A
t_{rr}			150	ns
			35	50 ns
R_{thJC}				1 K/W

IXYS reserves the right to change limits, test conditions, and dimensions.

IXYS MOSFETS and IGBTs are covered by one or more of the following U.S. patents: 4,835,592 4,881,106 5,017,508 5,049,961 5,187,117 5,486,715 6,306,728B1
4,850,072 4,931,844 5,034,796 5,063,307 5,237,481 5,381,025

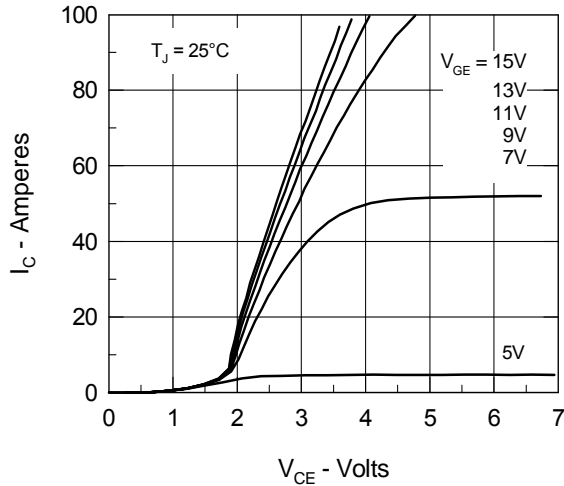

Fig. 1. Saturation Voltage Characteristics

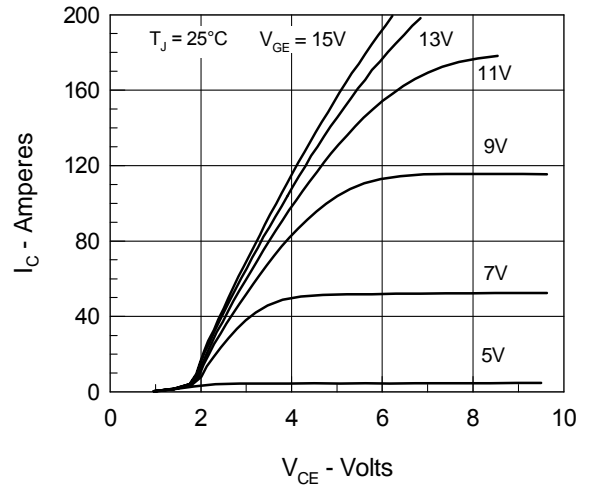

Fig. 2. Extended Output Characteristics

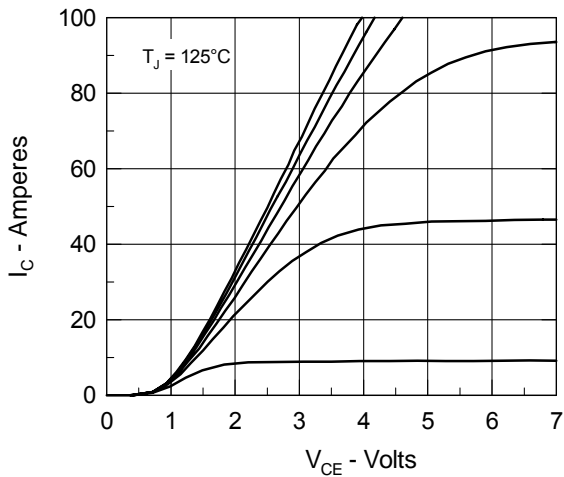

Fig. 3. Saturation Voltage Characteristics

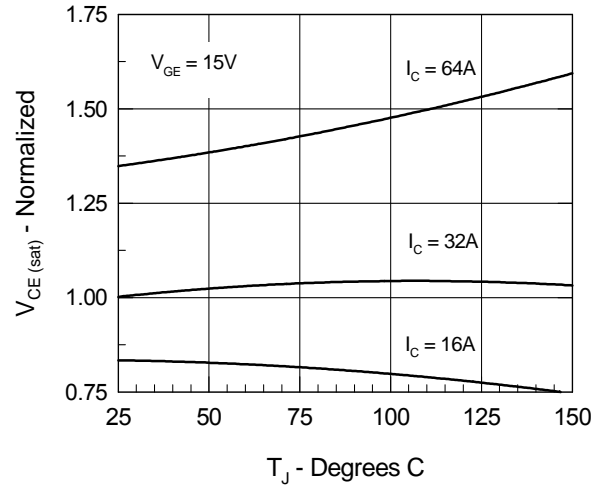
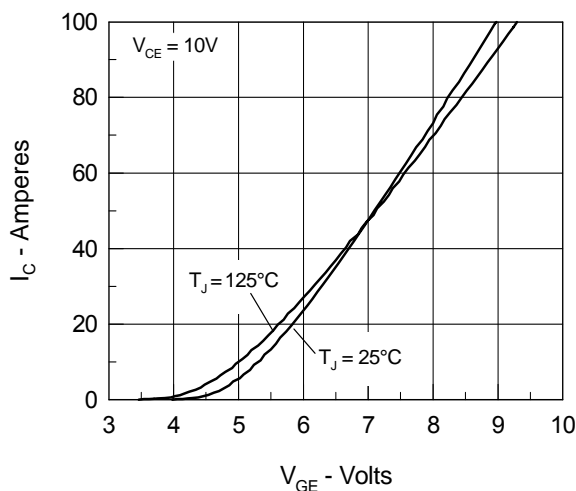
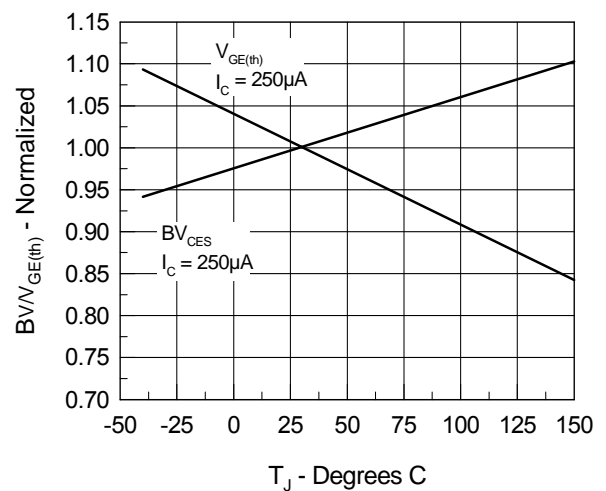

 Fig. 4. Temperature Dependence of $V_{CE(sat)}$

Fig. 5. Admittance Curves

 Fig. 6. Temperature Dependence of BV_{DSS} & $V_{GE(th)}$

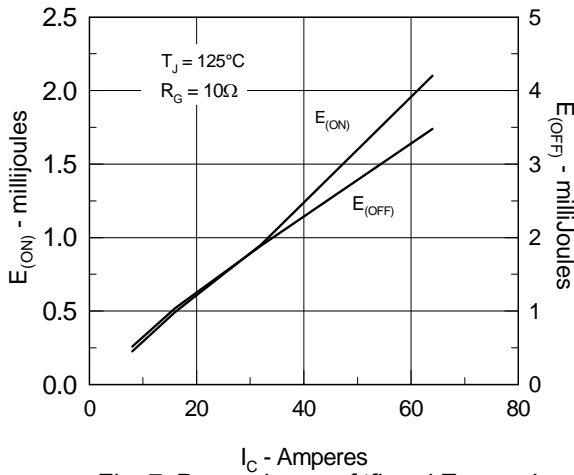

Fig. 7. Dependence of t_{fi} and E_{OFF} on I_C .

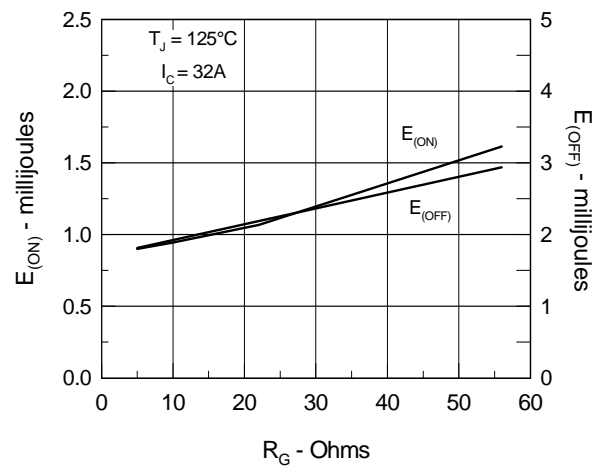

Fig. 8. Dependence of t_{fi} and E_{OFF} on R_G .

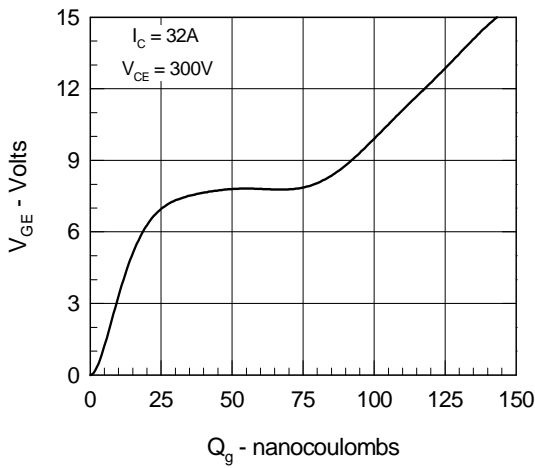

Fig. 9. Gate Charge

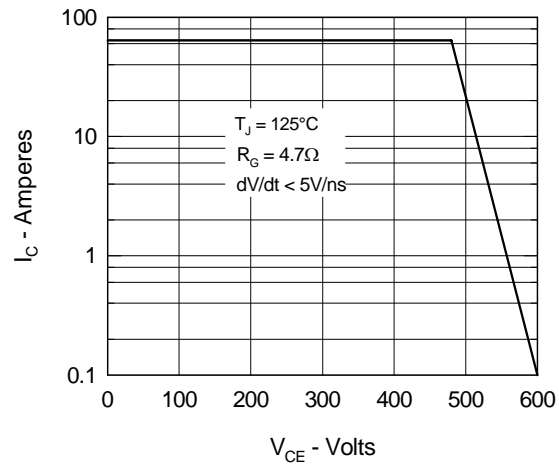

Fig. 10. Turn-off Safe Operating Area

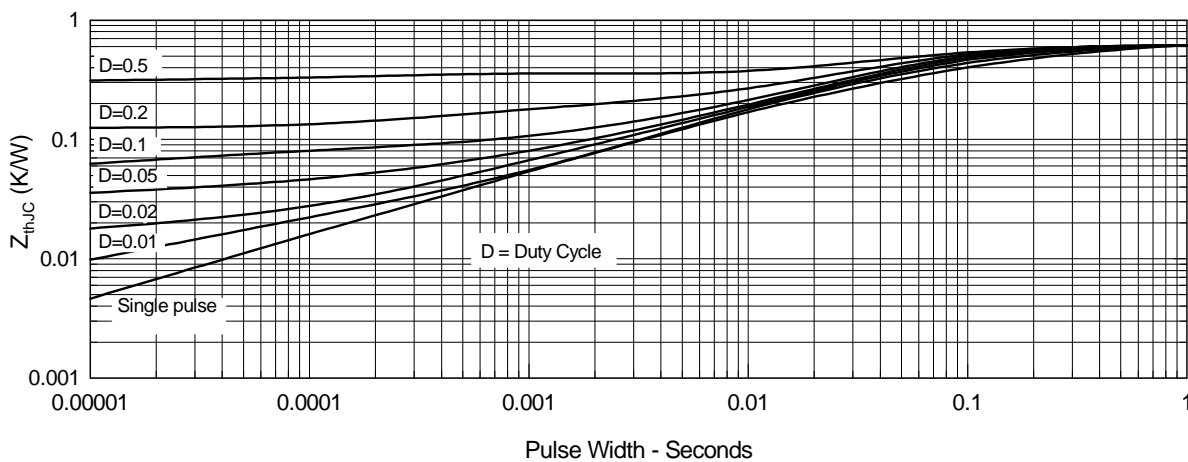

Fig. 11. Transient Thermal Resistance

IXYS reserves the right to change limits, test conditions, and dimensions.

IXYS MOSFETS and IGBTs are covered by one or more of the following U.S. patents:

4,835,592	4,881,106	5,017,508	5,049,961	5,187,117	5,486,715	6,306,728B1
4,850,072	4,931,844	5,034,796	5,063,307	5,237,481	5,381,025	

Fig.12 Maximum Forward Voltage Drop

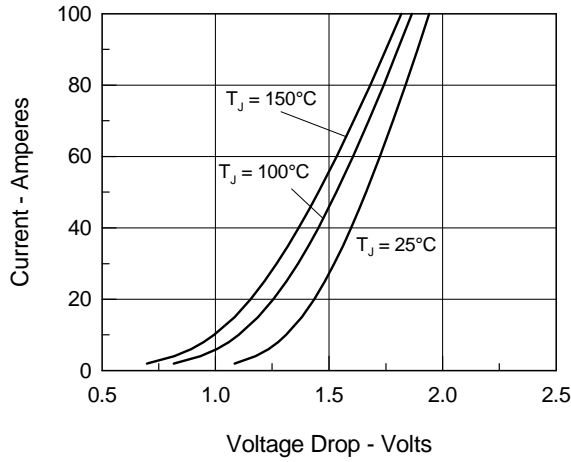

Fig.13 Peak Forward Voltage V_{FR} and Forward Recovery Time t_{FR}

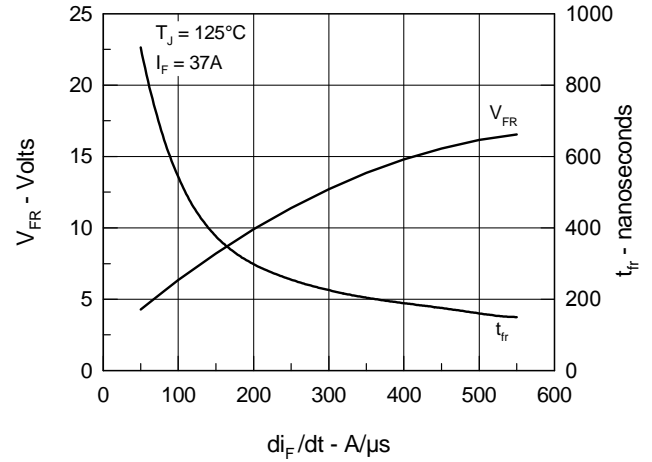

Fig.14 Junction Temperature Dependence of I_{RM} and Q_r

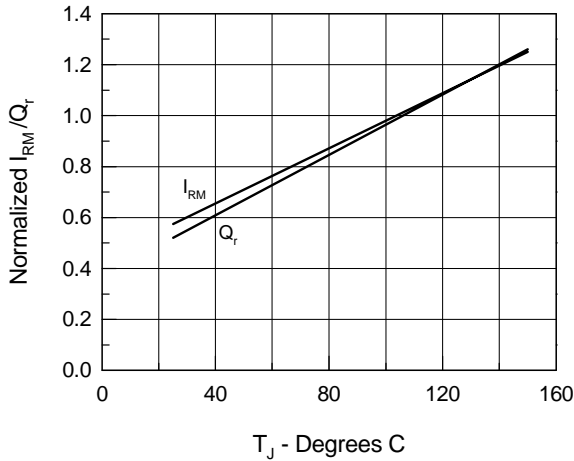

Fig.15 Reverse Recovery Charge

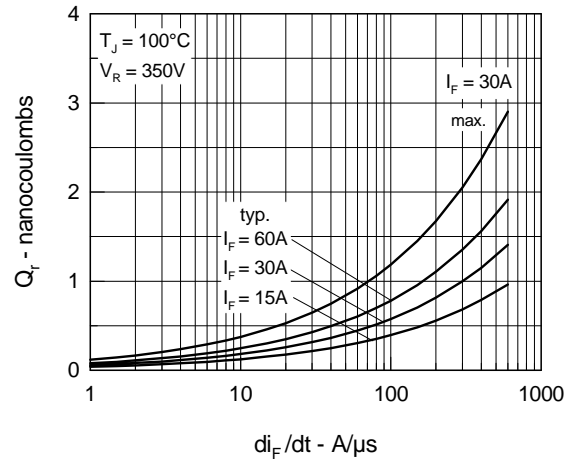

Fig.16 Peak Reverse Recovery Current

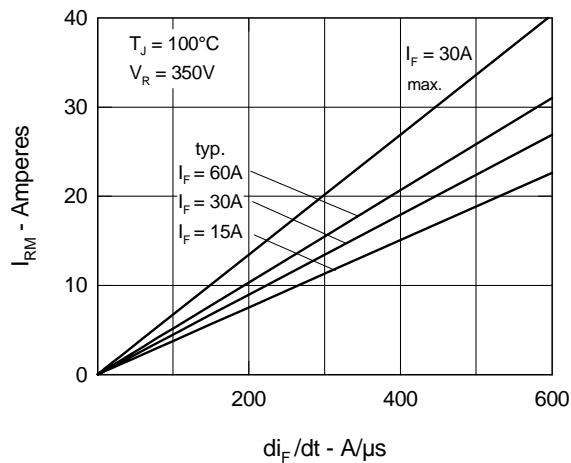

Fig.17 Reverse Recovery Time

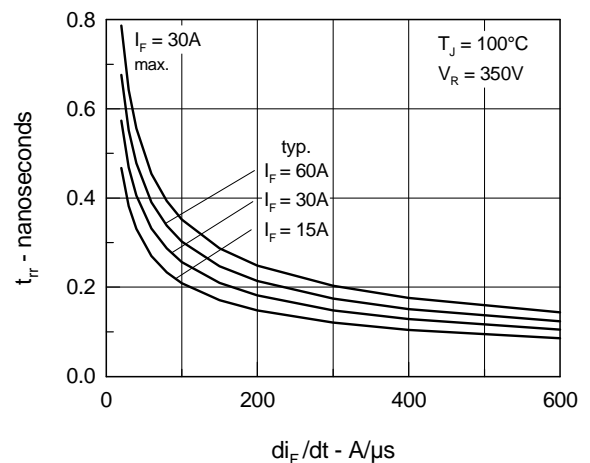
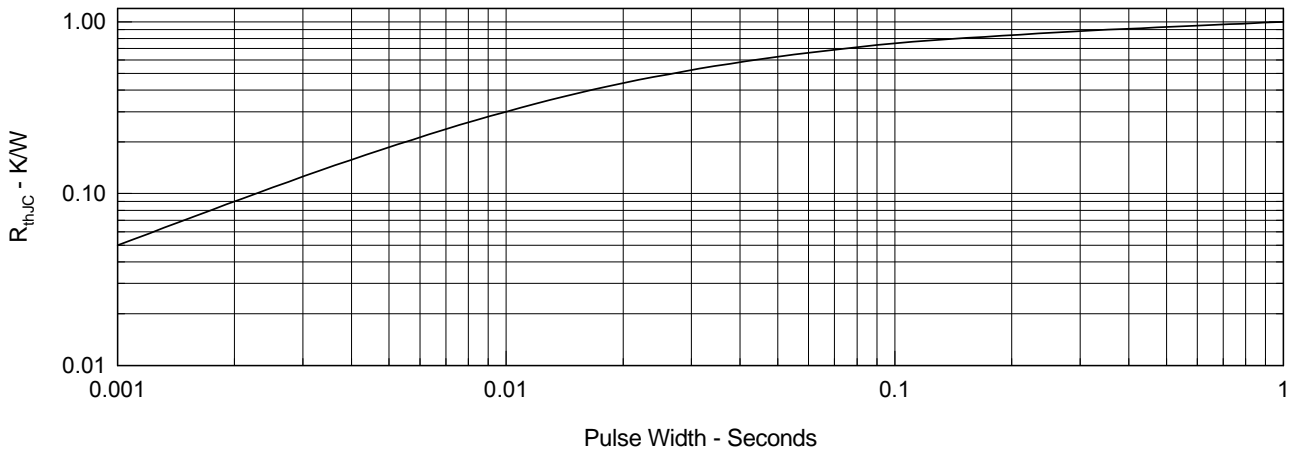

Fig.18 Diode Transient Thermal resistance junction to case



IXYS reserves the right to change limits, test conditions, and dimensions.

IXYS MOSFETS and IGBTs are covered by one or more of the following U.S. patents:

4,835,592	4,881,106	5,017,508	5,049,961	5,187,117	5,486,715	6,306,728B1
4,850,072	4,931,844	5,034,796	5,063,307	5,237,481	5,381,025	