

# High Voltage IGBT with optional Diode

Short Circuit SOA Capability  
Square RBSOA

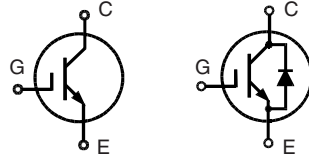

IXDH 30N120 IXDH 30N120 D1

$$V_{CES} = 1200 \text{ V}$$

$$I_{C25} = 60 \text{ A}$$

$$V_{CE(sat) \text{ typ}} = 2.4 \text{ V}$$

TO-247 AD (IXDH)

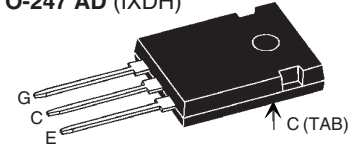

G = Gate, E = Emitter  
C = Collector, TAB = Collector

Symbol	Conditions	Maximum Ratings	
$V_{CES}$	$T_J = 25^\circ\text{C}$ to $150^\circ\text{C}$	1200	V
$V_{CGR}$	$T_J = 25^\circ\text{C}$ to $150^\circ\text{C}$ ; $R_{GE} = 20 \text{ k}\Omega$	1200	V
$V_{GES}$	Continuous	$\pm 20$	V
$V_{GEM}$	Transient	$\pm 30$	V
$I_{C25}$	$T_C = 25^\circ\text{C}$	60	A
$I_{C90}$	$T_C = 90^\circ\text{C}$	38	A
$I_{CM}$	$T_C = 90^\circ\text{C}$ ; $t_p = 1 \text{ ms}$	76	A
<b>RBSOA</b>	$V_{GE} = \pm 15 \text{ V}$ ; $T_J = 125^\circ\text{C}$ ; $R_G = 47 \Omega$ Clamped inductive load; $L = 30 \mu\text{H}$	$I_{CM} = 50$ $V_{CEK} < V_{CES}$	A
$t_{SC}$ <b>(SCSOA)</b>	$V_{GE} = \pm 15 \text{ V}$ ; $V_{CE} = V_{CES}$ ; $T_J = 125^\circ\text{C}$ $R_G = 47 \Omega$ , non repetitive	10	$\mu\text{s}$
$P_c$	$T_C = 25^\circ\text{C}$ ; IGBT Diode	300 135	W W
$T_J$		-55 ... +150	$^\circ\text{C}$
$T_{stg}$		-40 ... +150	$^\circ\text{C}$
$M_d$	Mounting torque	1.1/10	Nm/lb.in.
<b>Weight</b>		6	g

### Features

- NPT IGBT technology
- low saturation voltage
- low switching losses
- square RBSOA, no latch up
- high short circuit capability
- positive temperature coefficient for easy paralleling
- MOS input, voltage controlled
- optional ultra fast diode
- International standard packages

### Advantages

- Space savings
- High power density
- IXDT:  
surface mountable high power package

### Typical Applications

- AC motor speed control
- DC servo and robot drives
- DC choppers
- Uninterruptible power supplies (UPS)
- Switch-mode and resonant-mode power supplies

Symbol	Conditions	Characteristic Values ( $T_J = 25^\circ\text{C}$ , unless otherwise specified)		
		min.	typ.	max.
$V_{(BR)CES}$	$V_{GE} = 0 \text{ V}$	1200		V
$V_{GE(th)}$	$I_C = 1 \text{ mA}$ ; $V_{CE} = V_{GE}$	4.5		V
$I_{CES}$	$V_{CE} = V_{CES}$ ; $T_J = 25^\circ\text{C}$ $T_J = 125^\circ\text{C}$		2.5	1.5 mA mA
$I_{GES}$	$V_{CE} = 0 \text{ V}$ ; $V_{GE} = \pm 20 \text{ V}$			$\pm 500 \text{ nA}$
$V_{CE(sat)}$	$I_C = 30 \text{ A}$ ; $V_{GE} = 15 \text{ V}$	2.4	2.9	V

Symbol	Conditions	Characteristic Values			
		(T <sub>J</sub> = 25°C, unless otherwise specified)			
		min.	typ.	max.	
C <sub>ies</sub>	V <sub>CE</sub> = 25 V; V <sub>GE</sub> = 0 V; f = 1 MHz		1650	pF	
C <sub>oes</sub>			250	pF	
C <sub>res</sub>			110	pF	
Q <sub>g</sub>	I <sub>C</sub> = 30 A; V <sub>GE</sub> = 15 V; V <sub>CE</sub> = 0.5 V <sub>CES</sub>		120	nC	
t <sub>d(on)</sub>	Inductive load, T <sub>J</sub> = 125°C		100	ns	
t <sub>r</sub>			70	ns	
t <sub>d(off)</sub>			500	ns	
t <sub>f</sub>			70	ns	
E <sub>on</sub>		I <sub>C</sub> = 30 A; V <sub>GE</sub> = ±15 V;		4.6	mJ
E <sub>off</sub>		V <sub>CE</sub> = 600 V; R <sub>G</sub> = 47 Ω		3.4	mJ
R <sub>thJC</sub>	Package with heatsink compound			0.42 K/W	
R <sub>thCK</sub>			0.25	K/W	

Reverse Diode (FRED) [D1 version only]		Characteristic Values		
		(T <sub>J</sub> = 25°C, unless otherwise specified)		
Symbol	Conditions	min.	typ.	max.
V <sub>F</sub>	I <sub>F</sub> = 30 A; V <sub>GE</sub> = 0 V	2.5	2.7	V
	I <sub>F</sub> = 30 A; V <sub>GE</sub> = 0 V; T <sub>J</sub> = 125°C	2.0		V
I <sub>F</sub>	T <sub>C</sub> = 25°C		60	A
	T <sub>C</sub> = 90°C		35	A
I <sub>RM</sub>	I <sub>F</sub> = 30 A; -di <sub>F</sub> /dt = 400 A/μs; V <sub>R</sub> = 600 V	20		A
t <sub>rr</sub>	V <sub>GE</sub> = 0 V; T <sub>J</sub> = 125°C	200		ns
t <sub>rr</sub>	I <sub>F</sub> = 1 A; -di <sub>F</sub> /dt = 100 A/μs; V <sub>R</sub> = 30 V; V <sub>GE</sub> = 0 V	40		ns
R <sub>thJC</sub>				1 K/W

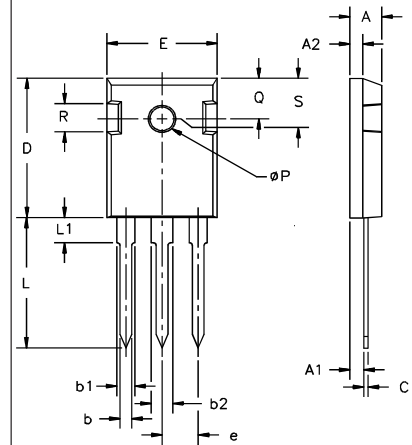
**TO-247 AD Outline**

Dim.	Millimeter		Inches	
	Min.	Max.	Min.	Max.
A	4.7	5.3	.185	.209
A <sub>1</sub>	2.2	2.54	.087	.102
A <sub>2</sub>	2.2	2.6	.059	.098
b	1.0	1.4	.040	.055
b <sub>1</sub>	1.65	2.13	.065	.084
b <sub>2</sub>	2.87	3.12	.113	.123
C	.4	.8	.016	.031
D	20.80	21.46	.819	.845
E	15.75	16.26	.610	.640
e	5.20	5.72	0.205	0.225
L	19.81	20.32	.780	.800
L1		4.50		.177
ØP	3.55	3.65	.140	.144
Q	5.89	6.40	0.232	0.252
R	4.32	5.49	.170	.216
S	6.15	BSC	242	BSC

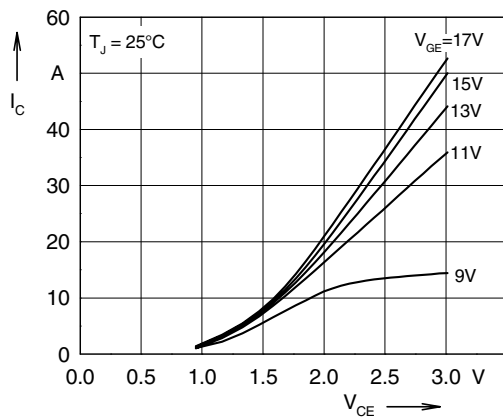

Fig. 1 Typ. output characteristics

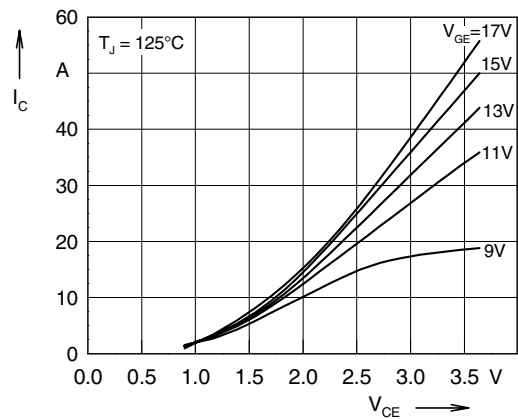

Fig. 2 Typ. output characteristics

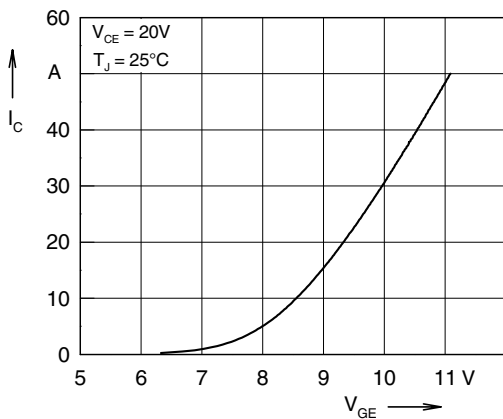

Fig. 3 Typ. transfer characteristics

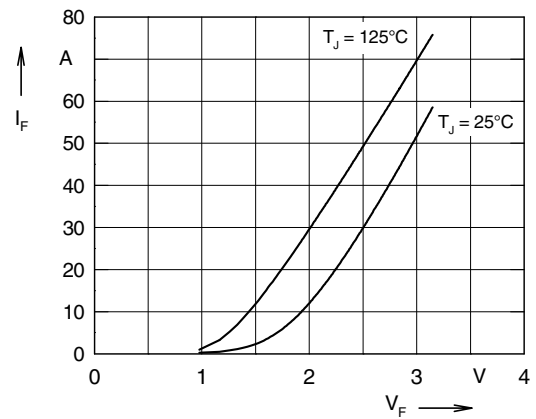

Fig. 4 Typ. forward characteristics of free wheeling diode

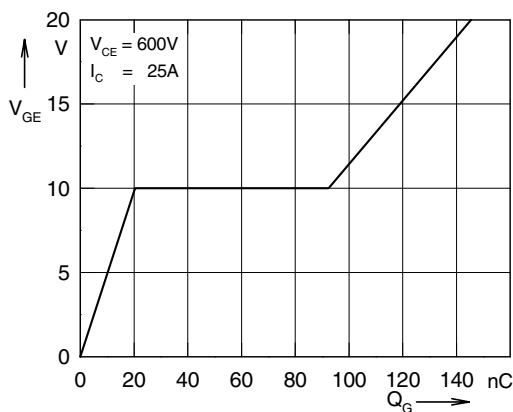

Fig. 5 Typ. turn on gate charge

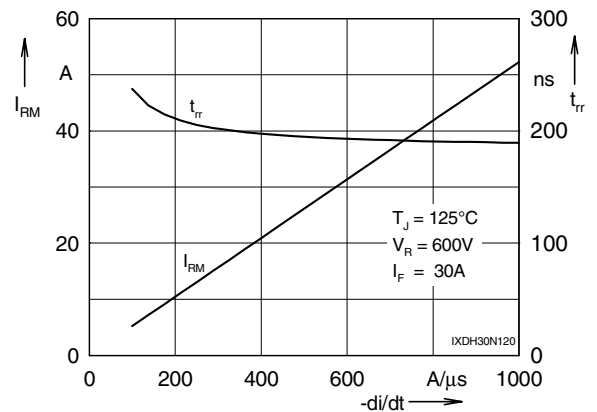

Fig. 6 Typ. turn off characteristics of free wheeling diode

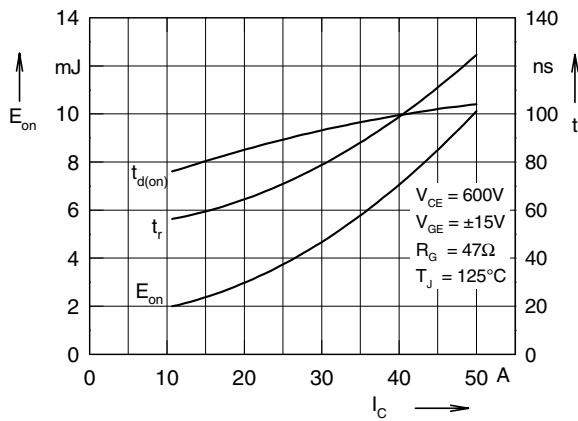

Fig. 7 Typ. turn on energy and switching times versus collector current

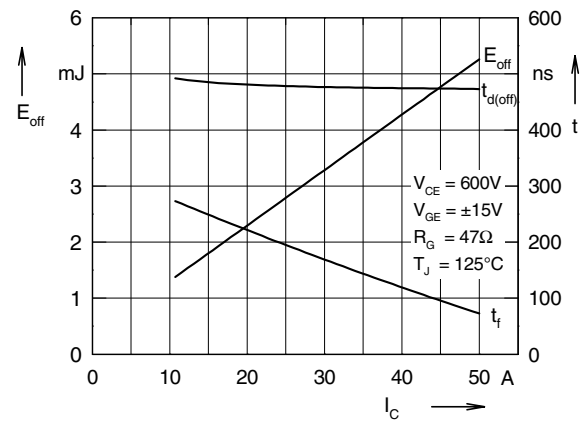

Fig. 8 Typ. turn off energy and switching times versus collector current

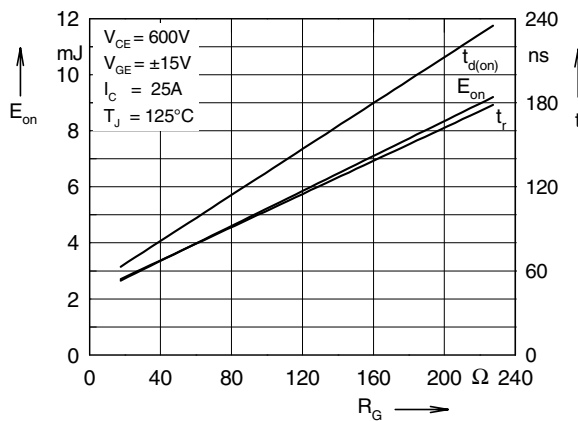

Fig. 9 Typ. turn on energy and switching times versus gate resistor

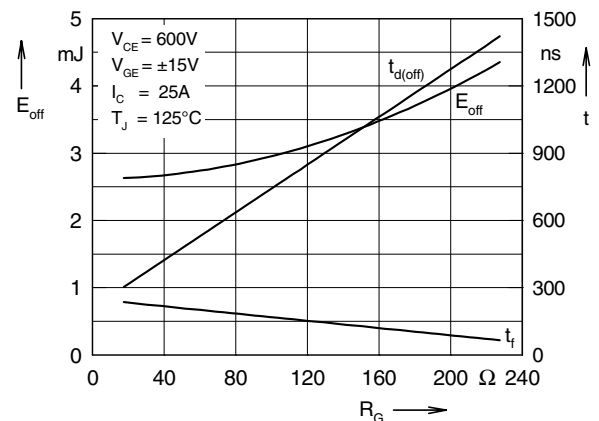

Fig. 10 Typ. turn off energy and switching times versus gate resistor

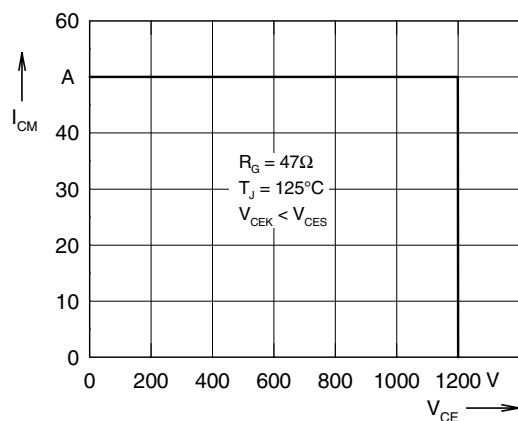

Fig. 11 Reverse biased safe operating area RBSOA

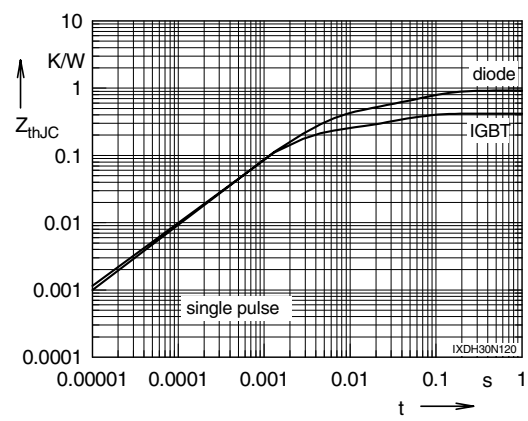

Fig. 12 Typ. transient thermal impedance