

NPT³ IGBT

$$I_{C25} = 60 \text{ A}$$

$$V_{CES} = 1200 \text{ V}$$

$$V_{CE(sat) \text{ typ.}} = 2.4 \text{ V}$$

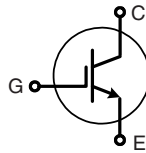

IXEH40N120

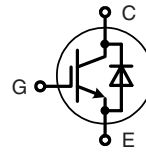

IXEH40N120D1

TO-247 AD

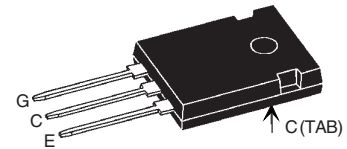

IGBT		
Symbol	Conditions	Maximum Ratings
V_{CES}	$T_{VJ} = 25^{\circ}\text{C to } 150^{\circ}\text{C}$	1200 V
V_{GES}		± 20 V
I_{C25}	$T_C = 25^{\circ}\text{C}$	60 A
I_{C90}	$T_C = 90^{\circ}\text{C}$	40 A
I_{CM} V_{CEK}	$V_{GE} = \pm 15 \text{ V}; R_G = 39 \Omega; T_{VJ} = 125^{\circ}\text{C}$ RBSOA, Clamped inductive load; $L = 100 \mu\text{H}$	50 A
		V_{CES}
t_{SC} (SCSOA)	$V_{CE} = 900\text{V}; V_{GE} = \pm 15 \text{ V}; R_G = 39 \Omega; T_{VJ} = 125^{\circ}\text{C}$ non-repetitive	10 μs
P_{tot}	$T_C = 25^{\circ}\text{C}$	300 W

Features

- NPT³ IGBT
 - low saturation voltage
 - positive temperature coefficient for easy paralleling
 - fast switching
 - short tail current for optimized performance in resonant circuits
- optional HiPerFRED™ diode
 - fast reverse recovery
 - low operating forward voltage
 - low leakage current
- TO-247 package
 - industry standard outline
 - epoxy meets UL 94V-0

Applications

- AC drives
- DC drives and choppers
- Uninterruptible power supplies (UPS)
- switched-mode and resonant-mode power supplies
- inductive heating, cookers

Symbol	Conditions	Characteristic Values ($T_{VJ} = 25^{\circ}\text{C}$, unless otherwise specified)		
		min.	typ.	max.
$V_{CE(sat)}$	$I_C = 40 \text{ A}; V_{GE} = 15 \text{ V}; T_{VJ} = 25^{\circ}\text{C}$ $T_{VJ} = 125^{\circ}\text{C}$	2.4	3.0	V
$V_{GE(th)}$	$I_C = 1 \text{ mA}; V_{GE} = V_{CE}$	4.5	6.5	V
I_{CES}	$V_{CE} = V_{CES}; V_{GE} = 0 \text{ V}; T_{VJ} = 25^{\circ}\text{C}$ $T_{VJ} = 125^{\circ}\text{C}$	0.4	0.4	mA
I_{GES}	$V_{CE} = 0 \text{ V}; V_{GE} = \pm 20 \text{ V}$		200	nA
$t_{d(on)}$ t_r $t_{d(off)}$ t_f E_{on} E_{off}	Inductive load, $T_{VJ} = 125^{\circ}\text{C}$ $V_{CE} = 600 \text{ V}; I_C = 40 \text{ A}$ $V_{GE} = \pm 15 \text{ V}; R_G = 39 \Omega$	85		ns
		50		ns
		440		ns
		50		ns
		6.1		mJ
		3.0		mJ
C_{ies}	$V_{CE} = 25 \text{ V}; V_{GE} = 0 \text{ V}; f = 1 \text{ MHz}$	2		nF
Q_{Gon}	$V_{CE} = 600 \text{ V}; V_{GE} = 15 \text{ V}; I_C = 35 \text{ A}$	150		nC
R_{thJC}			0.42	K/W

Diode [D1 version only]

Symbol	Conditions	Maximum Ratings	
I_{F25}	$T_C = 25^\circ\text{C}$	60	A
I_{F90}	$T_C = 90^\circ\text{C}$	35	A

Symbol	Conditions	Characteristic Values		
		min.	typ.	max.
V_F	$I_F = 40\text{ A}; T_{VJ} = 25^\circ\text{C}$ $T_{VJ} = 125^\circ\text{C}$	2.6 2.0	3.0	V V
I_{RM} t_{Tr} $E_{rec(off)}$	$I_F = 30\text{ A}; di_F/dt = -500\text{ A}/\mu\text{s}; T_{VJ} = 125^\circ\text{C}$ $V_R = 600\text{ V}; V_{GE} = 0\text{ V}$	51		A
		180		ns
		1.8		mJ
R_{thJC}			1.0	K/W

Component

Symbol	Conditions	Maximum Ratings	
T_{VJ}		-55...+150	$^\circ\text{C}$
T_{stg}		-55...+150	$^\circ\text{C}$
M_d	mounting torque	0.8...1.2	Nm

Symbol	Conditions	Characteristic Values		
		min.	typ.	max.
R_{thCH}	with heatsink compound	0.25		K/W
Weight		6		g

Equivalent Circuits for Simulation

Conduction

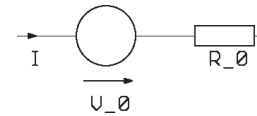

IGBT (typ. at $V_{GE} = 15\text{ V}; T_J = 125^\circ\text{C}$)
 $V_0 = 0.95\text{ V}; R_0 = 45\text{ m}\Omega$

Diode (typ. at $T_J = 125^\circ\text{C}$)
 $V_0 = 1.26\text{ V}; R_0 = 15\text{ m}\Omega$

Thermal Response

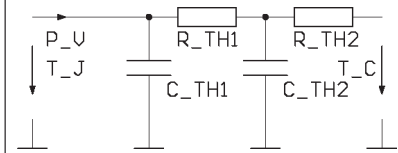

IGBT

$C_{th1} = 0.007\text{ J/K}; R_{th1} = 0.215\text{ K/W}$
 $C_{th2} = 0.187\text{ J/K}; R_{th2} = 0.205\text{ K/W}$

Diode

$C_{th1} = 0.006\text{ J/K}; R_{th1} = 0.649\text{ K/W}$
 $C_{th2} = 0.113\text{ J/K}; R_{th2} = 0.351\text{ K/W}$

TO-247 AD Outline

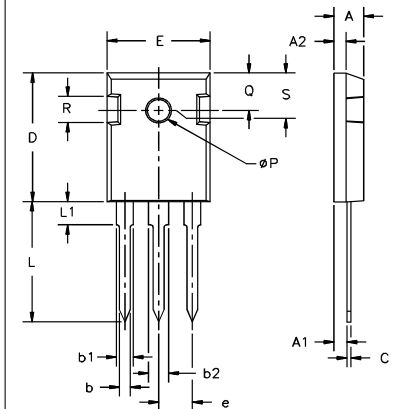

Dim.	Millimeter		Inches	
	Min.	Max.	Min.	Max.
A	4.7	5.3	.185	.209
A ₁	2.2	2.54	.087	.102
A ₂	2.2	2.6	.059	.098
b	1.0	1.4	.040	.055
b ₁	1.65	2.13	.065	.084
b ₂	2.87	3.12	.113	.123
C	.4	.8	.016	.031
D	20.80	21.46	.819	.845
E	15.75	16.26	.610	.640
e	5.20	5.72	0.205	0.225
L	19.81	20.32	.780	.800
L1		4.50		.177
∅P	3.55	3.65	.140	.144
Q	5.89	6.40	0.232	0.252
R	4.32	5.49	.170	.216
S	6.15	BSC	.242	BSC

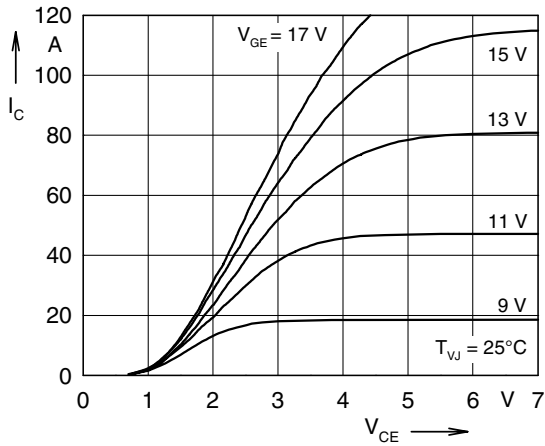

Fig. 1 Typ. output characteristics

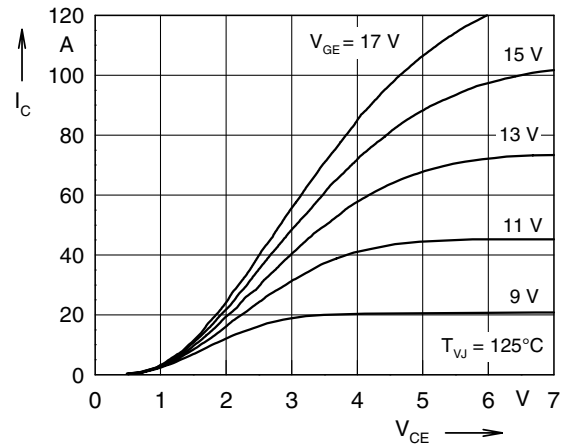

Fig. 2 Typ. output characteristics

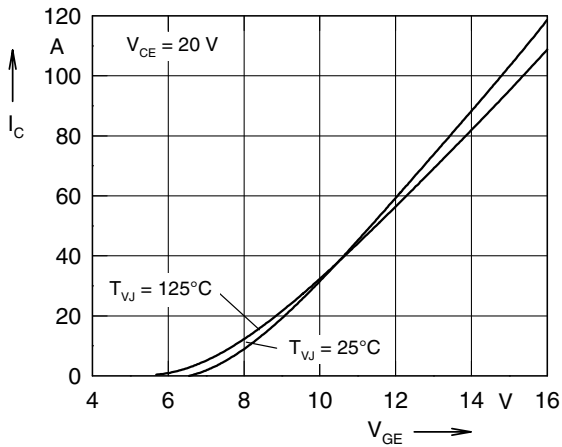

Fig. 3 Typ. transfer characteristics

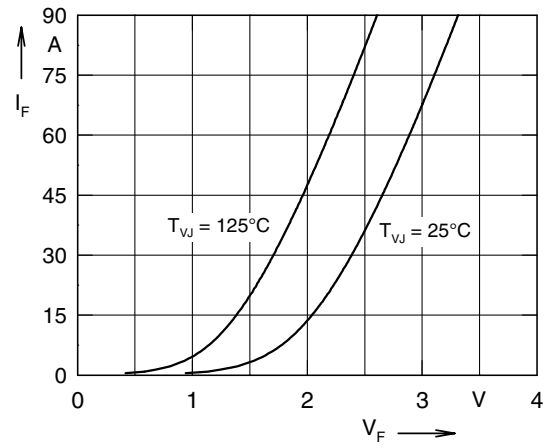

Fig. 4 Typ. forward characteristics of free wheeling diode

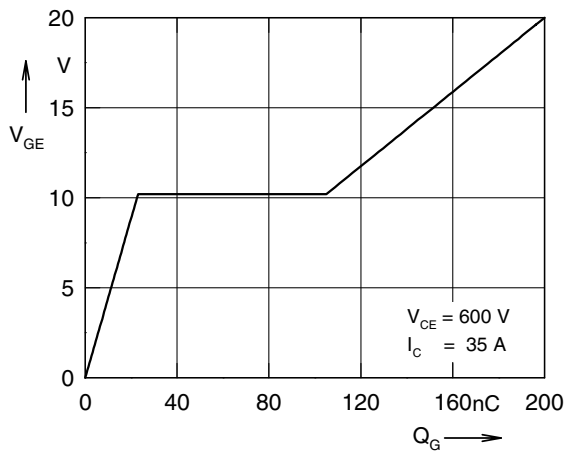

Fig. 5 Typ. turn on gate charge

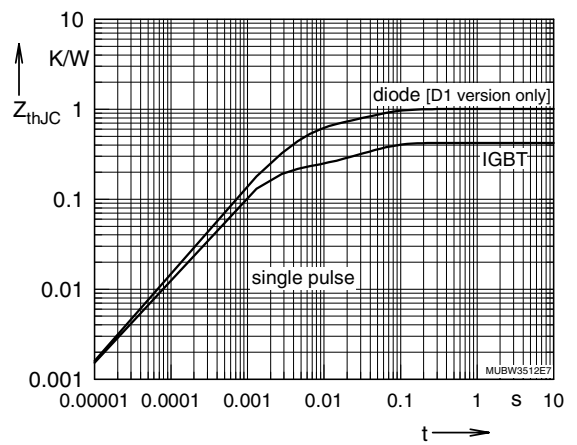

Fig. 6 Typ. transient thermal impedance

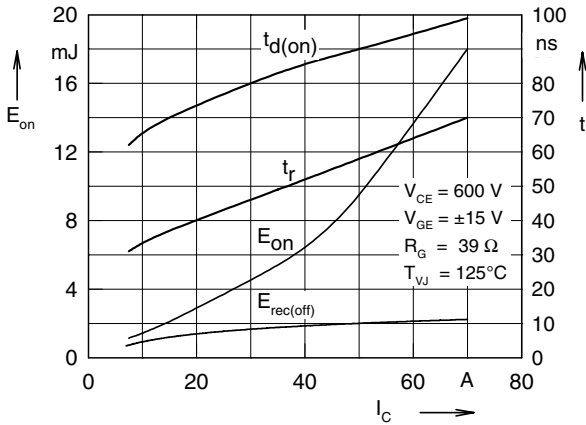

Fig. 7 Typ. turn on energy and switching times versus collector current

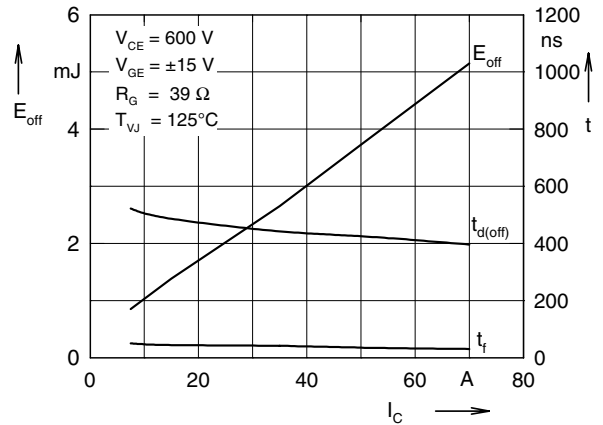

Fig. 8 Typ. turn off energy and switching times versus collector current

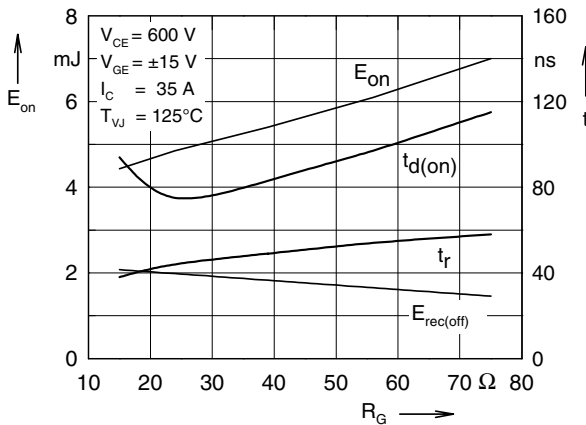

Fig. 9 Typ. turn on energy and switching times versus gate resistor

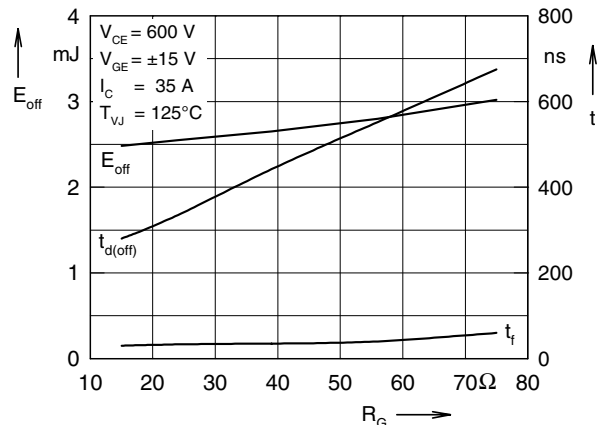

Fig. 10 Typ. turn off energy and switching times versus gate resistor

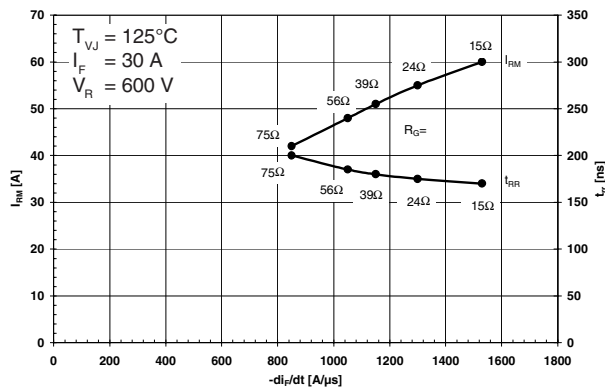

Fig. 11 Typ. turn off characteristics of free wheeling diode

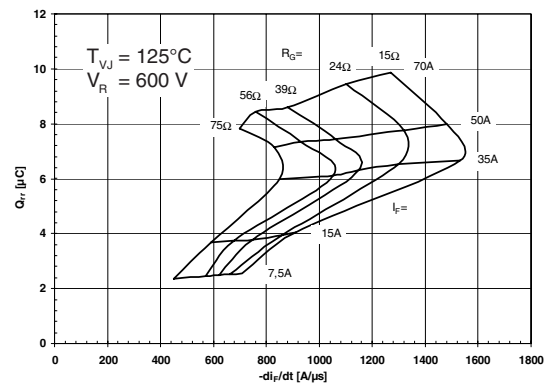

Fig. 12 Typ. turn off characteristics of free wheeling diode