

# IRGP20B120UD-EP

## INSULATED GATE BIPOLAR TRANSISTOR WITH ULTRAFAST SOFT RECOVERY DIODE

## UltraFast CoPack IGBT

### Features

- UltraFast Non Punch Through (NPT) Technology
- Low Diode  $V_F$  (1.67V Typical @ 20A & 25°C)
- 10  $\mu$ s Short Circuit Capability
- Square RBSOA
- UltraSoft Diode Recovery Characteristics
- Positive  $V_{CE(on)}$  Temperature Coefficient
- Extended Lead TO-247AD Package

### Benefits

- Benchmark Efficiency Above 20KHz
- Optimized for Welding, UPS, and Induction Heating Applications
- Rugged with UltraFast Performance
- Low EMI
- Significantly Less Snubber Required
- Excellent Current Sharing in Parallel Operation
- Longer Leads for Easier Mounting

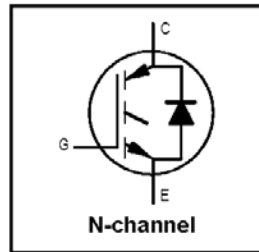

$V_{CES} = 1200V$
$V_{CE(on)} \text{ typ.} = 3.05V$
$V_{GE} = 15V, I_C = 20A, 25^\circ C$

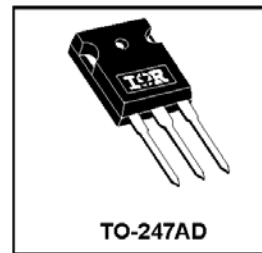

### Absolute Maximum Ratings

	Parameter	Max.	Units
$V_{CES}$	Collector-to-Emitter Breakdown Voltage	1200	V
$I_C @ T_C = 25^\circ C$	Continuous Collector Current (Fig.1)	40	A
$I_C @ T_C = 100^\circ C$	Continuous Collector Current (Fig.1)	20	
$I_{CM}$	Pulsed Collector Current (Fig.3, Fig. CT.5)	120	
$I_{LM}$	Clamped Inductive Load Current (Fig.4, Fig. CT.2)	120	
$I_F @ T_C = 100^\circ C$	Diode Continuous Forward Current	20	
$I_{FM}$	Diode Maximum Forward Current	120	V
$V_{GE}$	Gate-to-Emitter Voltage	$\pm 20$	
$P_D @ T_C = 25^\circ C$	Maximum Power Dissipation (Fig.2)	300	W
$P_D @ T_C = 100^\circ C$	Maximum Power Dissipation (Fig.2)	120	
$T_J$	Operating Junction and	-55 to + 150	°C
$T_{STG}$	Storage Temperature Range		
	Soldering Temperature, for 10 seconds	300, (0.063 in. (1.6mm) from case)	
	Mounting Torque, 6-32 or M3 screw.	10 lbf-in (1.1N-m)	

### Thermal Resistance

	Parameter	Min.	Typ.	Max.	Units
$R_{\theta JC}$	Junction-to-Case - IGBT	---	---	0.42	°C/W
$R_{\theta JC}$	Junction-to-Case - Diode	---	---	0.83	
$R_{\theta CS}$	Case-to-Sink, flat, greased surface	---	0.24	---	
$R_{\theta JA}$	Junction-to-Ambient, typical socket mount	---	---	40	
$W_t$	Weight	---	6 (0.21)	---	g (oz)
$Z_{\theta JC}$	Transient Thermal Impedance Junction-to-Case (Fig.24)				

# IRGP20B120UD-EP

International  
**IR** Rectifier

## Electrical Characteristics @ T<sub>J</sub> = 25°C (unless otherwise specified)

	Parameter	Min.	Typ.	Max.	Units	Conditions	Fig.
V <sub>(BR)CES</sub>	Collector-to-Emitter Breakdown Voltage	1200			V	V <sub>GE</sub> = 0V, I <sub>c</sub> = 250 μA	
ΔV <sub>(BR)CES</sub> / ΔT <sub>J</sub>	Temperature Coeff. of Breakdown Voltage		+1.2		V/°C	V <sub>GE</sub> = 0V, I <sub>c</sub> = 1 mA (25 - 125 °C)	
V <sub>CE(on)</sub>	Collector-to-Emitter Saturation Voltage		3.05	3.45	V	I <sub>c</sub> = 20A, V <sub>GE</sub> = 15V	6.6
			3.37	3.80		I <sub>c</sub> = 25A, V <sub>GE</sub> = 15V	7.9
			4.23	4.85		I <sub>c</sub> = 40A, V <sub>GE</sub> = 15V	10
			3.89	4.50		I <sub>c</sub> = 20A, V <sub>GE</sub> = 15V, T <sub>J</sub> = 125°C	11
			4.31	5.06		I <sub>c</sub> = 25A, V <sub>GE</sub> = 15V, T <sub>J</sub> = 125°C	
V <sub>GE(th)</sub>	Gate Threshold Voltage	4.0	5.0	6.0	V	V <sub>CE</sub> = V <sub>GE</sub> , I <sub>c</sub> = 250 μA	9,10,11,12
ΔV <sub>GE(th)</sub> / ΔT <sub>J</sub>	Temperature Coeff. of Threshold Voltage		- 1.2		mV/°C	V <sub>CE</sub> = V <sub>GE</sub> , I <sub>c</sub> = 1 mA (25 - 125 °C)	
g <sub>fe</sub>	Forward Transconductance	13.6	15.7	17.8	S	V <sub>CE</sub> = 50V, I <sub>c</sub> = 20A, PW=80μs	
I <sub>CES</sub>	Zero Gate Voltage Collector Current			250	μA	V <sub>GE</sub> = 0V, V <sub>CE</sub> = 1200V	
			420	750		V <sub>GE</sub> = 0V, V <sub>CE</sub> = 1200V, T <sub>J</sub> = 125°C	
			1482	2200		V <sub>GE</sub> = 0V, V <sub>CE</sub> = 1200V, T <sub>J</sub> = 150°C	
V <sub>FM</sub>	Diode Forward Voltage Drop		1.67	1.96	V	I <sub>c</sub> = 20A	8
			1.76	2.06		I <sub>c</sub> = 25A	
			1.73	2.03		I <sub>c</sub> = 20A, T <sub>J</sub> = 125°C	
			1.87	2.18		I <sub>c</sub> = 25A, T <sub>J</sub> = 125°C	
I <sub>GES</sub>	Gate-to-Emitter Leakage Current			±100	nA	V <sub>GE</sub> = ±20V	

## Switching Characteristics @ T<sub>J</sub> = 25°C (unless otherwise specified)

	Parameter	Min.	Typ.	Max.	Units	Conditions	Fig.
Q <sub>g</sub>	Total Gate charge (turn-on)		169	254	nC	I <sub>c</sub> = 20A	23
Q <sub>ge</sub>	Gate - Emitter Charge (turn-on)		24	36		V <sub>CC</sub> = 600V	CT1
Q <sub>gc</sub>	Gate - Collector Charge (turn-on)		82	126		V <sub>GE</sub> = 15V	
E <sub>on</sub>	Turn-On Switching Loss		850	1050	μJ	I <sub>c</sub> = 20A, V <sub>CC</sub> = 600V	CT4
E <sub>off</sub>	Turn-Off Switching Loss		425	650		V <sub>GE</sub> = 15V, R <sub>g</sub> = 5Ω, L = 200μH	WF1
E <sub>tot</sub>	Total Switching Loss		1275	1800		T <sub>J</sub> = 25°C, Energy losses include tail and diode reverse recovery	WF2
E <sub>on</sub>	Turn-on Switching Loss		1350	1550	μJ	I <sub>c</sub> = 20A, V <sub>CC</sub> = 600V	13, 16
E <sub>off</sub>	Turn-off Switching Loss		610	875		V <sub>GE</sub> = 15V, R <sub>g</sub> = 5Ω, L = 200μH	CT4
E <sub>tot</sub>	Total Switching Loss		1960	2425		T <sub>J</sub> = 125°C, Energy losses include tail and diode reverse recovery	WF1 & 2
td(on)	Turn - on delay time		50	65	ns	I <sub>c</sub> = 20A, V <sub>CC</sub> = 600V	14, 16
tr	Rise time		20	30		V <sub>GE</sub> = 15V, R <sub>g</sub> = 5Ω, L = 200μH	CT4
td(off)	Turn - off delay time		204	230		T <sub>J</sub> = 125°C	WF1
tf	Fall time		24	35			WF2
C <sub>ies</sub>	Input Capacitance		2200		pF	V <sub>GE</sub> = 0V	22
C <sub>oes</sub>	Output Capacitance		210			V <sub>CC</sub> = 30V	
C <sub>res</sub>	Reverse Transfer Capacitance		85			f = 1.0 MHz	
RBSOA	Reverse bias safe operating area	FULL SQUARE				T <sub>J</sub> = 150°C, I <sub>c</sub> = 120A V <sub>CC</sub> = 1000V, V <sub>P</sub> = 1200V R <sub>g</sub> = 5Ω, V <sub>GE</sub> = +15V to 0V	4 CT2
SCSOA	Short Circuit Safe Operating Area	10	----	----	μs	T <sub>J</sub> = 150°C V <sub>CC</sub> = 900V, V <sub>P</sub> = 1200V R <sub>g</sub> = 5Ω, V <sub>GE</sub> = +15V to 0V	CT3 WF4
E <sub>rec</sub>	Reverse recovery energy of the diode		1600	2100	μJ	T <sub>J</sub> = 125°C	17,18,19
t <sub>rr</sub>	Diode Reverse recovery time		300		ns	V <sub>CC</sub> = 600V, I <sub>c</sub> = 20A	20, 21
I <sub>rr</sub>	Peak Reverse Recovery Current		32	36	A	V <sub>GE</sub> = 15V, R <sub>g</sub> = 5Ω, L = 200μH	CT4, WF3
L <sub>e</sub>	Internal Emitter Inductance		13		nH	Measured 5 mm from the package.	

Fig.1 - Maximum DC Collector Current vs. Case Temperature

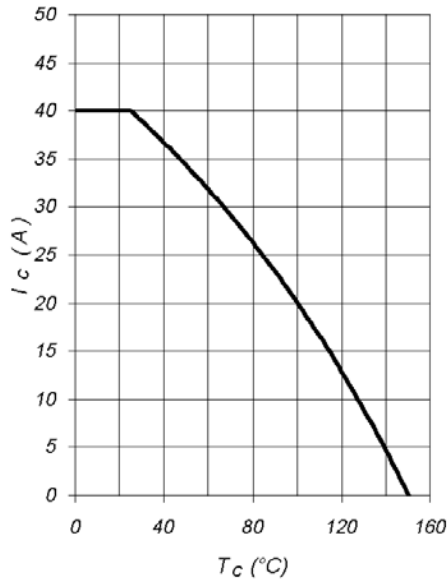

Fig.2 - Power Dissipation vs. Case Temperature

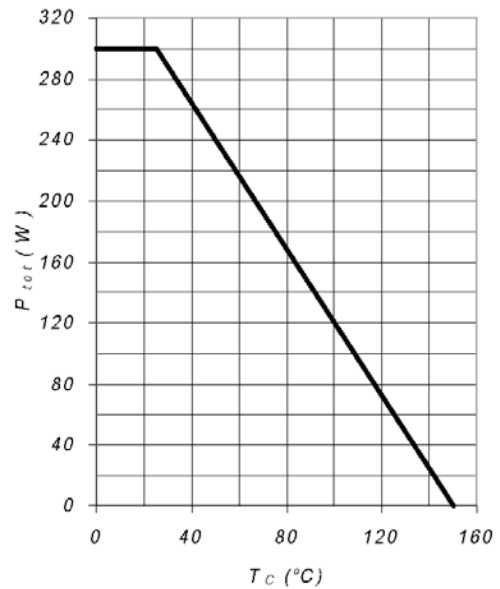

Fig.3 - Forward SOA  
 $T_C=25^\circ\text{C}; T_J \leq 150^\circ\text{C}$

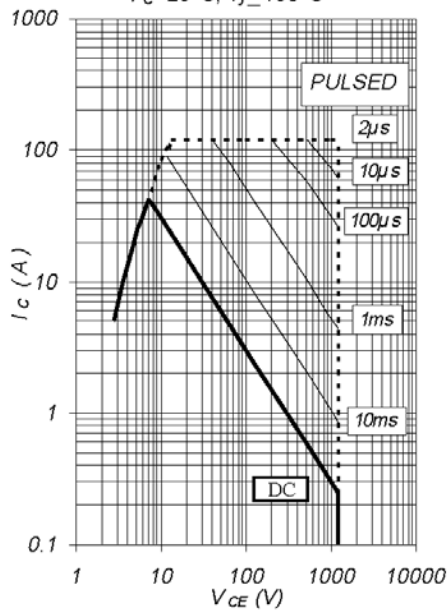

Fig.4 - Reverse Bias SOA  
 $T_J = 150^\circ\text{C}, V_{GE} = 15\text{V}$

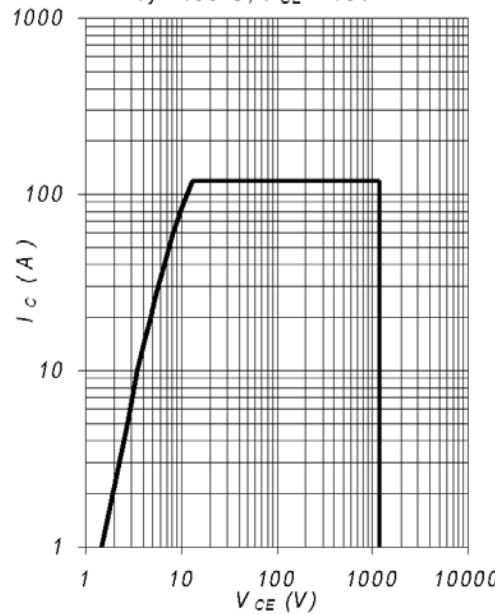

Fig.5 - Typical IGBT Output Characteristics  
 $T_j = -40^\circ\text{C}; t_p = 300\mu\text{s}$

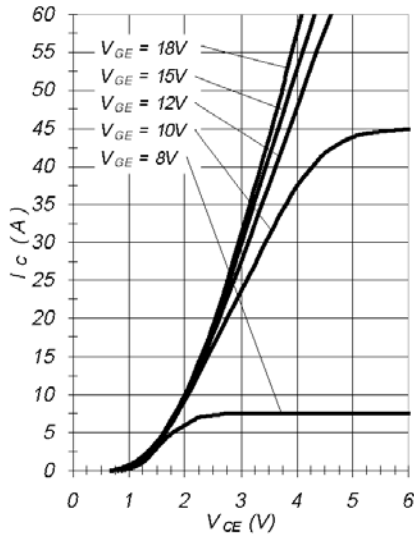

Fig.6 - Typical IGBT Output Characteristics  
 $T_j = 25^\circ\text{C}; t_p = 300\mu\text{s}$

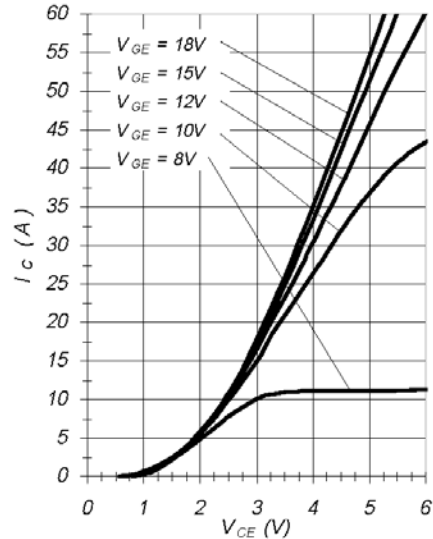

Fig.7 - Typical IGBT Output Characteristics  
 $T_j = 125^\circ\text{C}; t_p = 300\mu\text{s}$

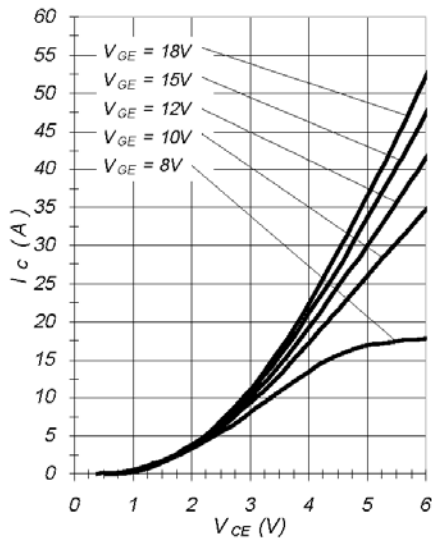

Fig.8 - Typical Diode Forward Characteristic  
 $t_p = 300\mu\text{s}$

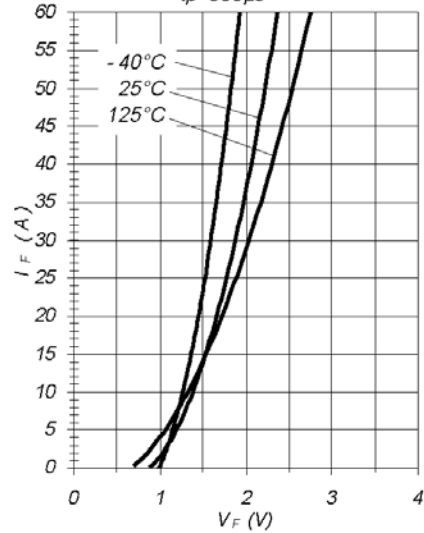

Fig.9 - Typical  $V_{CE}$  vs  $V_{GE}$   
 $T_j = -40^\circ\text{C}$

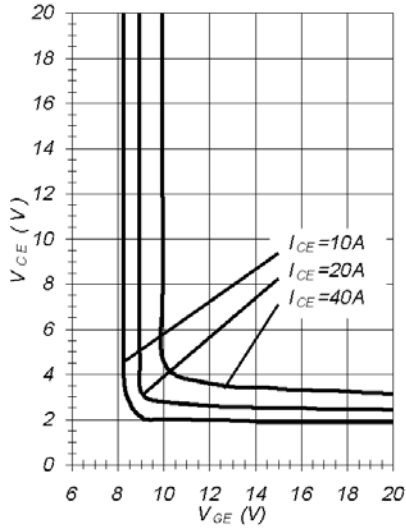

Fig.10 - Typical  $V_{CE}$  vs  $V_{GE}$   
 $T_j = 25^\circ\text{C}$

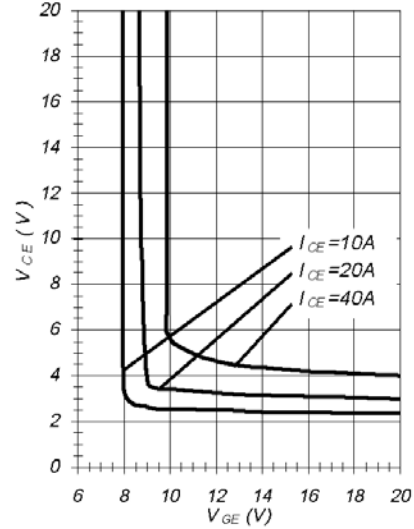

Fig.11 - Typical  $V_{CE}$  vs  $V_{GE}$   
 $T_j = 125^\circ\text{C}$

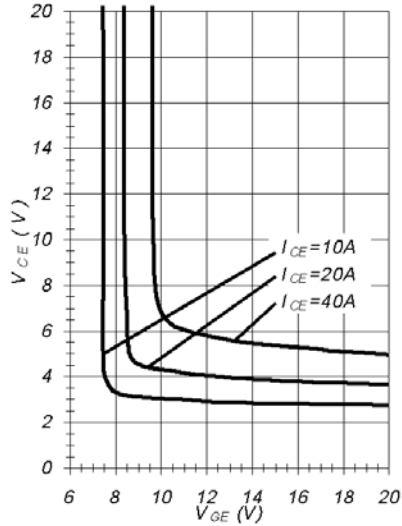

Fig.12 - Typ. Transfer Characteristics  
 $V_{CE} = 20\text{V}$ ;  $t_p = 20\mu\text{s}$

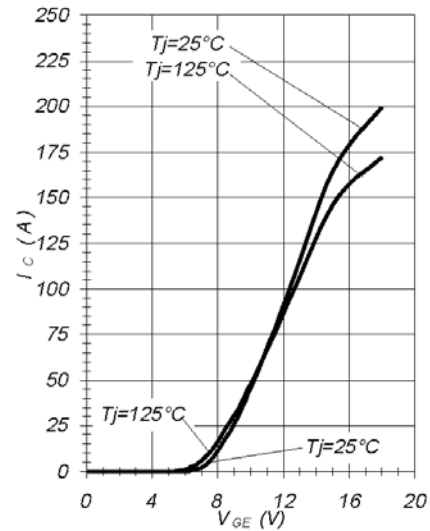

Fig. 13 - Typical Energy Loss vs  $I_C$   
 $T_j=125^\circ\text{C}$ ;  $L=200\mu\text{H}$ ;  $V_{CE}=600\text{V}$ ;  
 $R_g=22\Omega$ ;  $V_{GE}=15\text{V}$

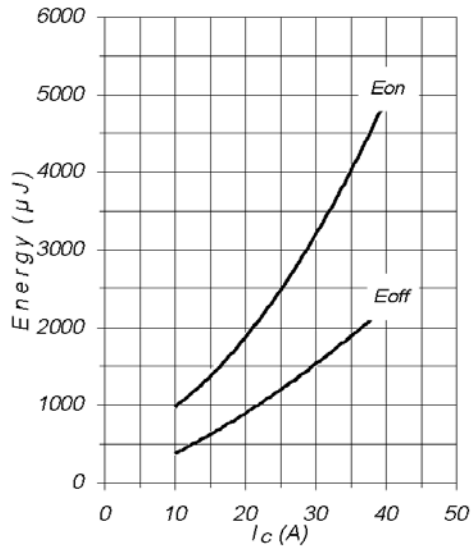

Fig. 14 - Typical Switching Time vs  $I_C$   
 $T_j=125^\circ\text{C}$ ;  $L=200\mu\text{H}$ ;  $V_{CE}=600\text{V}$ ;  
 $R_g=22\Omega$ ;  $V_{GE}=15\text{V}$

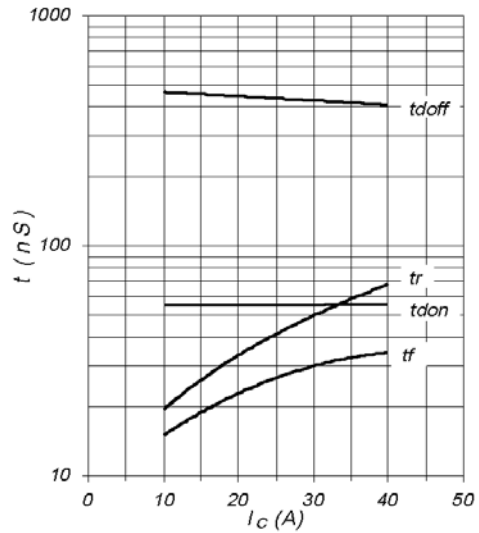

Fig. 15 - Typical Energy Loss vs  $R_g$   
 $T_j=125^\circ\text{C}$ ;  $L=200\mu\text{H}$ ;  $V_{CE}=600\text{V}$ ;  
 $I_{CE}=20\text{A}$ ;  $V_{GE}=15\text{V}$

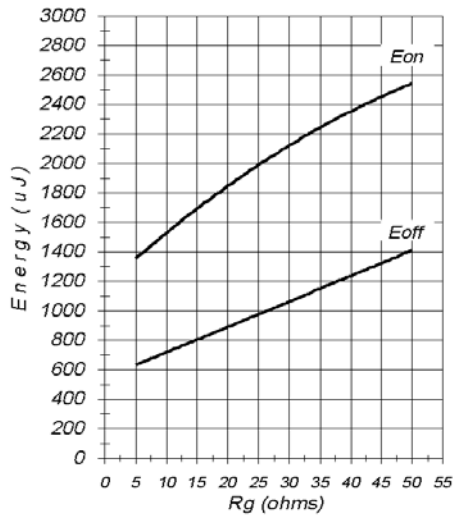

Fig. 16 - Typical Switching Time vs  $R_g$   
 $T_j=125^\circ\text{C}$ ;  $L=200\mu\text{H}$ ;  $V_{CE}=600\text{V}$ ;  
 $I_{CE}=20\text{A}$ ;  $V_{GE}=15\text{V}$

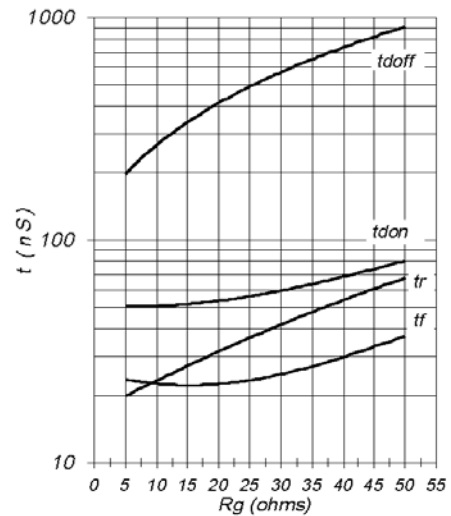

Fig.17 - Typical Diode  $I_{RR}$  vs  $I_F$   
 $T_j=125^\circ\text{C}$

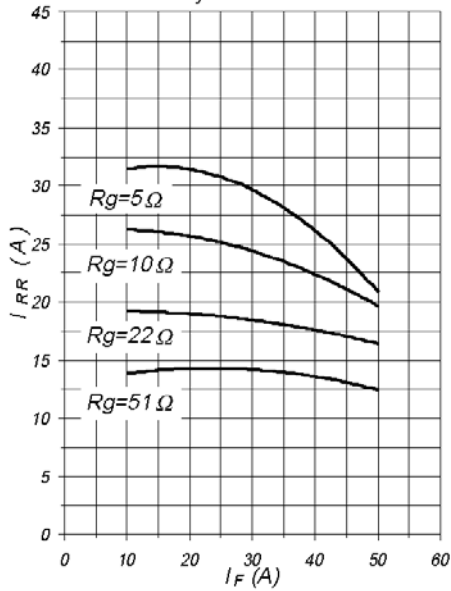

Fig.18 - Typical Diode  $I_{RR}$  vs  $R_g$   
 $T_j=125^\circ\text{C}; I_F=20\text{A}$

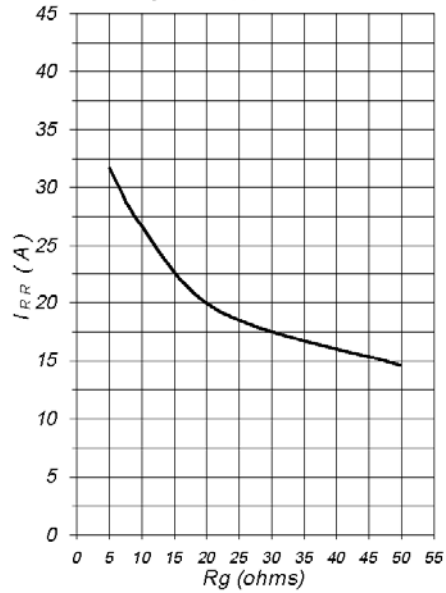

Fig.19 - Typical Diode  $I_{RR}$  vs  $di_F/dt$   
 $V_{CC}=600\text{V}; V_{GE}=15\text{V}$   
 $I_F=20\text{A}; T_j=125^\circ\text{C}$

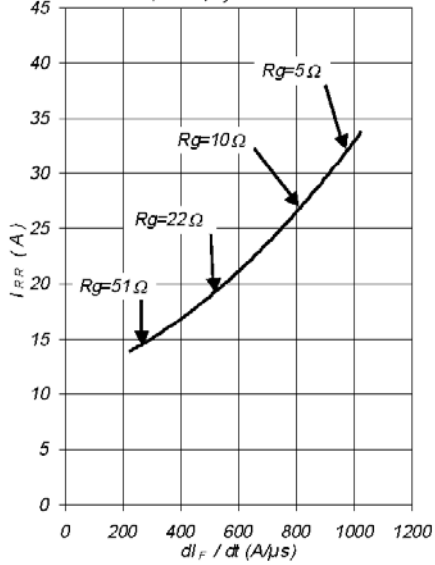
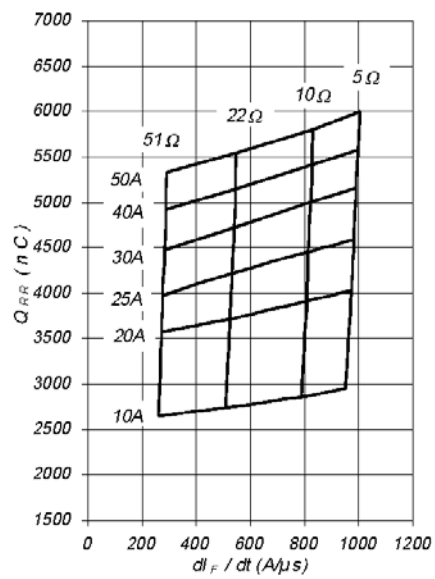

Fig.20 - Typical Diode  $Q_{RR}$   
 $V_{CC}=600\text{V}; V_{GE}=15\text{V}; T_j=125^\circ\text{C}$



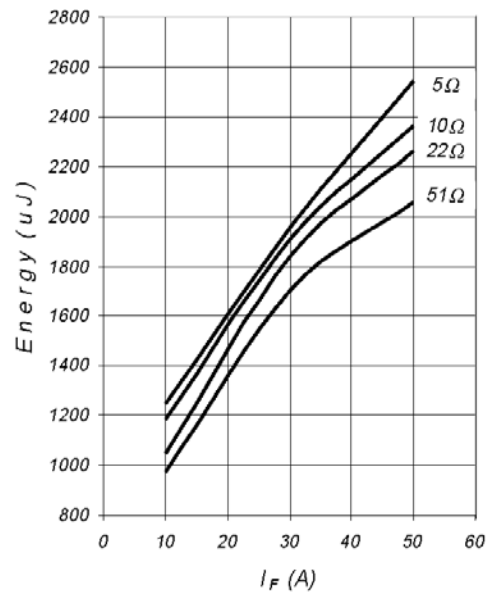

Fig.22 - Typical Capacitance vs  $V_{CE}$   
 $V_{GE}=0V$ ;  $f=1MHz$

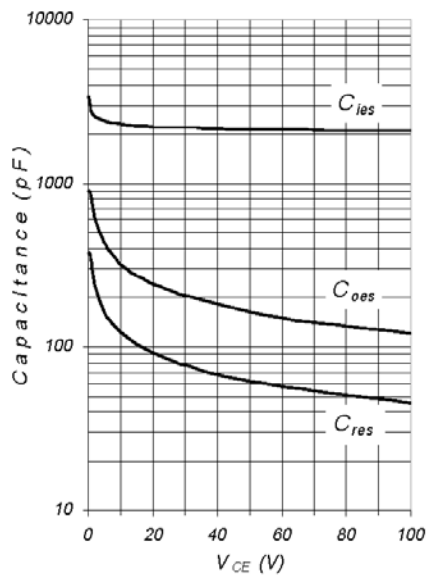

Fig.23 - Typ. Gate Charge vs.  $V_{GE}$   
 $I_C=20A$ ;  $L=600\mu H$

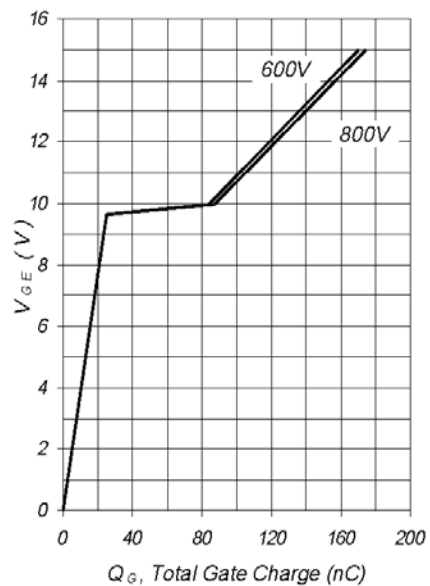
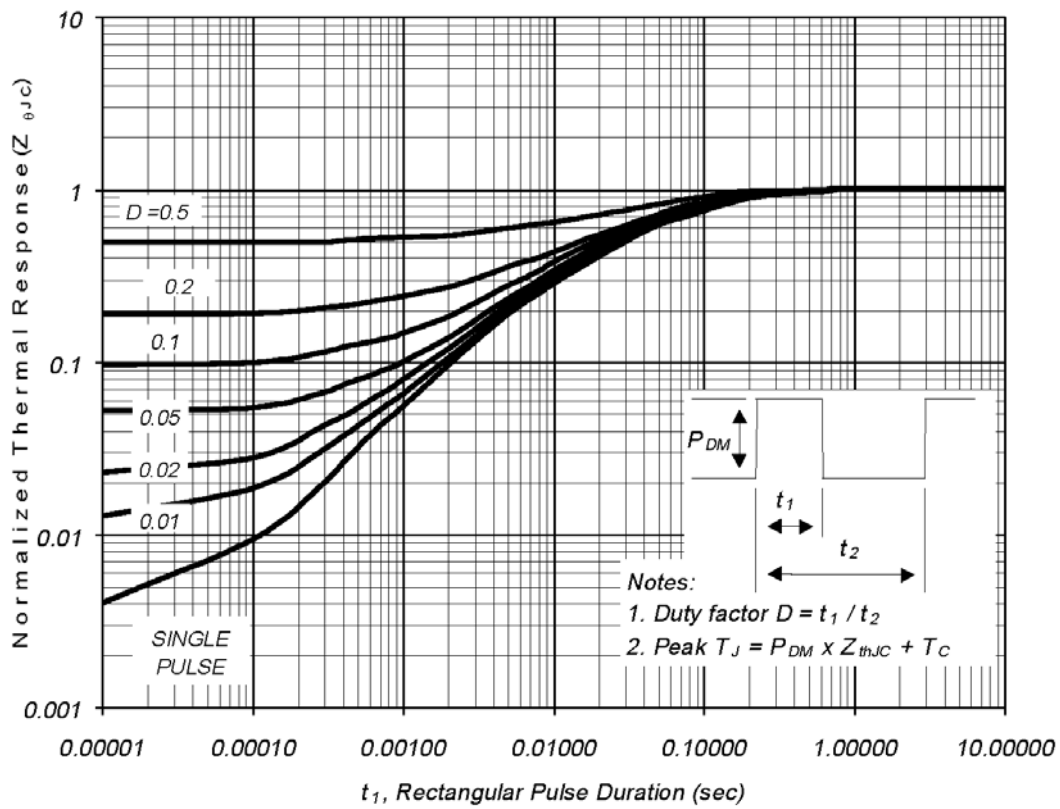
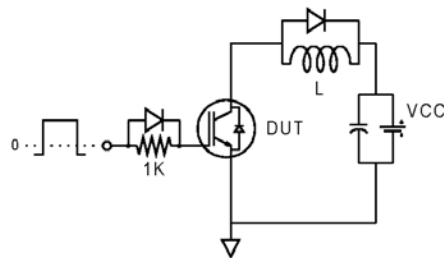



Fig.24 - Normalized Transient Thermal Impedance, Junction-to-Case



**Fig. CT.1 - Gate Charge Circuit (turn-off)**



**Fig. CT.2 - RBSOA Circuit**

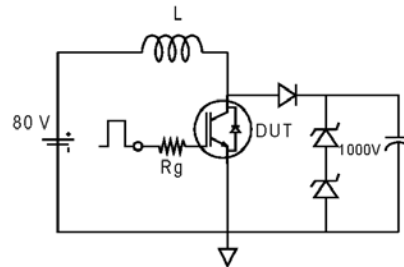

**Fig. CT.3 - S.C. SOA Circuit**

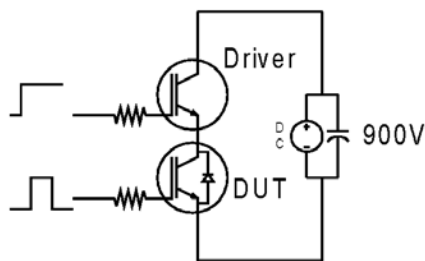

**Fig. CT.4 - Switching Loss Circuit**

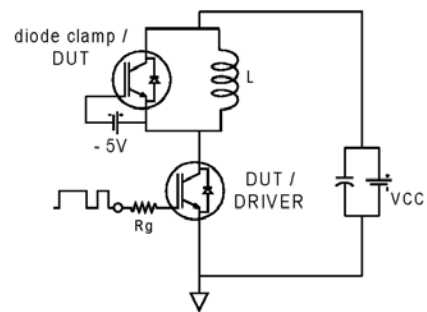

**Fig. CT.5 - Resistive Load Circuit**

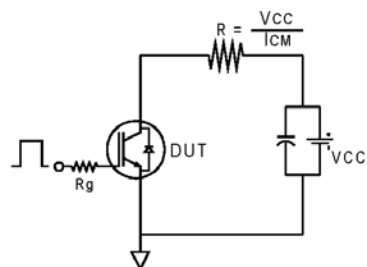

Fig. WF.1 - Typ. Turn-off Loss Waveform  
@  $T_j=125^\circ\text{C}$  using Fig. CT.4

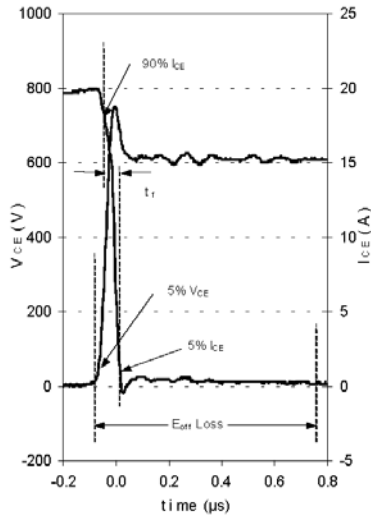

Fig. WF.2 - Typ. Turn-on Loss Waveform  
@  $T_j=125^\circ\text{C}$  using Fig. CT.4

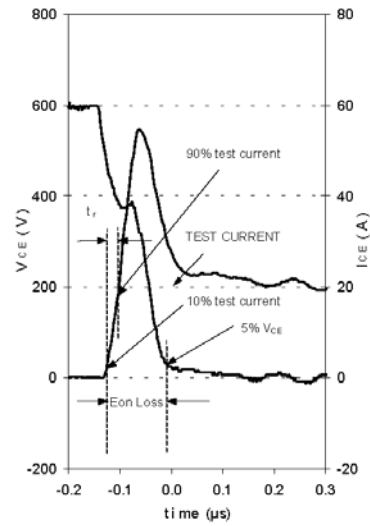

Fig. WF.3 - Typ. Diode Recovery Waveform  
@  $T_j=125^\circ\text{C}$  using Fig. CT.4

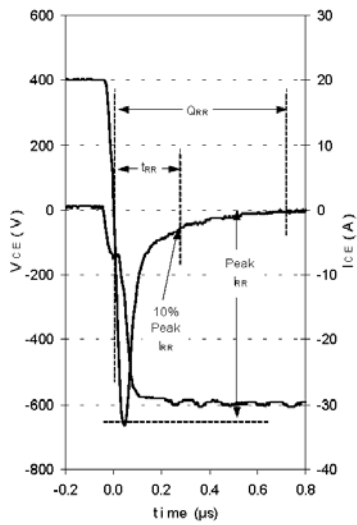
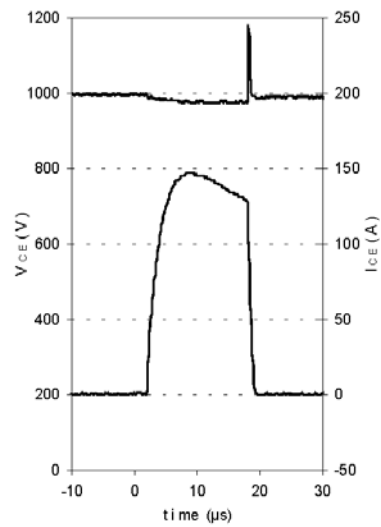

Fig. WF.4 - Typ. S.C. Waveform  
@  $T_C=150^\circ\text{C}$  using Fig. CT.3



# IRGP20B120UD-EP

International  
**IR** Rectifier

## TO-247AD Package Outline

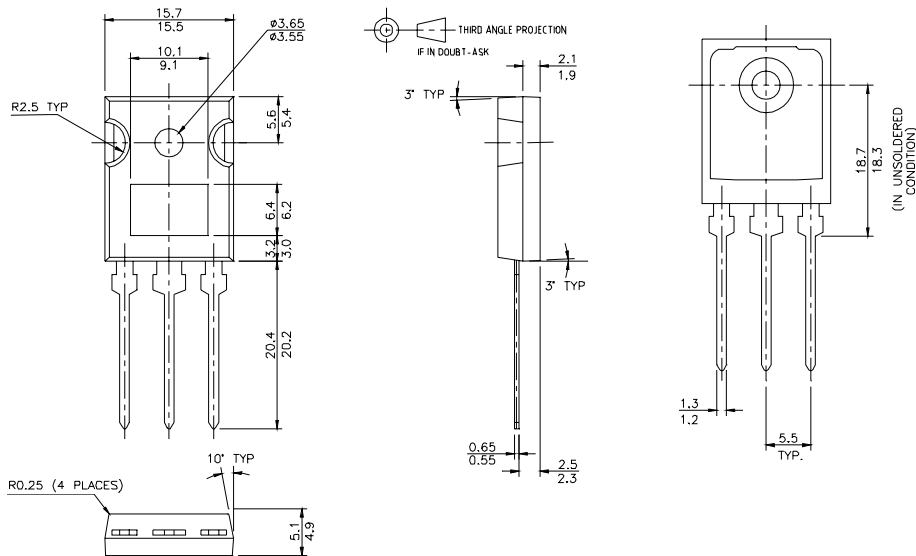

## TO-247AD Part Marking Information

EXAMPLE: THIS IS AN IRGP30B120KD-E  
WITH ASSEMBLY  
LOT CODE 5657  
ASSEMBLED ON WW 35, 2000  
IN THE ASSEMBLY LINE "H"

Note: "P" in assembly line position  
indicates "Lead-Free"

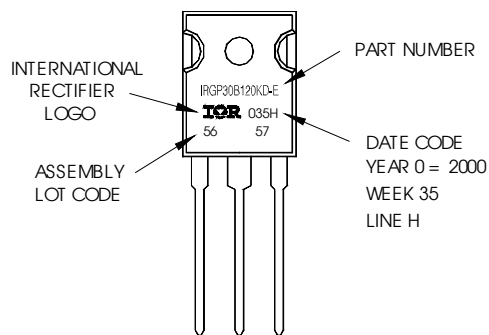

Data and specifications subject to change without notice.

International  
**IR** Rectifier

**IR WORLD HEADQUARTERS:** 233 Kansas St., El Segundo, California 90245, USA Tel: (310) 252-7105  
TAC Fax: (310) 252-7903

Visit us at [www.irf.com](http://www.irf.com) for sales contact information.07/04

[www.irf.com](http://www.irf.com)

Note: For the most current drawings please refer to the IR website at:  
<http://www.irf.com/package/>