

# HiPerFAST™ IGBT ISOPLUS247™

IXGR 40N60B2  
IXGR 40N60B2D1

$V_{CES} = 600\text{ V}$   
 $I_{C25} = 75\text{ A}$   
 $V_{CE(sat)} = 1.9\text{ V}$   
 $t_{fi\text{ typ}} = 82\text{ ns}$

## C2-Class High Speed IGBTs (Electrically Isolated Back Surface)

Optimized for 10-25 KHz hard switching  
and up to 150 KHz resonant switching

Preliminary Data Sheet

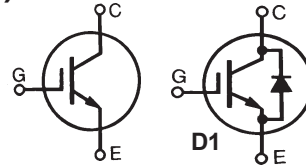

Symbol	Test Conditions	Maximum Ratings	
$V_{CES}$	$T_J = 25^\circ\text{C}$ to $150^\circ\text{C}$	600	V
$V_{CGR}$	$T_J = 25^\circ\text{C}$ to $150^\circ\text{C}$ ; $R_{GE} = 1\text{ M}\Omega$	600	V
$V_{GES}$	Continuous	$\pm 20$	V
$V_{GEM}$	Transient	$\pm 30$	V
$I_{C25}$	$T_C = 25^\circ\text{C}$	60	A
$I_{C110}$	$T_C = 110^\circ\text{C}$	33	A
$I_{F110}$	$T_C = 110^\circ\text{C}$ (IXGR40N60B2D1)	25	A
$I_{CM}$	$T_C = 25^\circ\text{C}$ , 1 ms	200	A
<b>SSOA</b> <b>(RBSOA)</b>	$V_{GE} = 15\text{ V}$ , $T_{VJ} = 125^\circ\text{C}$ , $R_G = 10\ \Omega$ Clamped inductive load @ $\leq 600\text{ V}$	$I_{CM} = 80$	A
$P_C$	$T_C = 25^\circ\text{C}$	167	W
$T_J$		-55 ... +150	$^\circ\text{C}$
$T_{JM}$		150	$^\circ\text{C}$
$T_{stg}$		-55 ... +150	$^\circ\text{C}$
$V_{ISOL}$	50/60 Hz RMS, $t = 1\text{ m}$	2500	V
	Maximum lead temperature for soldering 1.6 mm (0.062 in.) from case for 10 s	300	$^\circ\text{C}$
<b>Weight</b>		6	g

ISOPLUS247 (IXGR)  
E153432

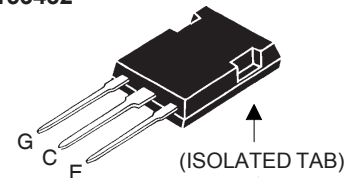

G = Gate,  
E = Emitter

C = Collector,

### Features

- DCB Isolated mounting tab
- Meets TO-247AD package Outline
- High current handling capability
- Latest generation HDMOS™ process
- MOS Gate turn-on  
- drive simplicity

### Applications

- Uninterruptible power supplies (UPS)
- Switched-mode and resonant-mode power supplies
- AC motor speed control
- DC servo and robot drives
- DC choppers

### Advantages

- Easy assembly
- High power density
- Very fast switching speeds for high frequency applications

Symbol	Test Conditions	Characteristic Values ( $T_J = 25^\circ\text{C}$ , unless otherwise specified)		
		min.	typ.	max.
$V_{GE(th)}$	$I_C = 250\ \mu\text{A}$ , $V_{CE} = V_{GE}$	3.0		5.0 V
$I_{CES}$	$V_{CE} = V_{CES}$ $V_{GE} = 0\text{ V}$			$T_J = 25^\circ\text{C}$ : 50 $\mu\text{A}$ $T_J = 150^\circ\text{C}$ : 1 mA
$I_{GES}$	$V_{CE} = 0\text{ V}$ , $V_{GE} = \pm 20\text{ V}$			$\pm 100\text{ nA}$
$V_{CE(sat)}$	$I_C = 30\text{ A}$ , $V_{GE} = 15\text{ V}$			$T_J = 25^\circ\text{C}$ : 1.9 V

Symbol	Test Conditions	Characteristic Values ( $T_J = 25^\circ\text{C}$ , unless otherwise specified)			
		min.	typ.	max.	
$g_{fs}$	$I_C = 30\text{ A}$ ; $V_{CE} = 10\text{ V}$ , Pulse test, $t \leq 300\ \mu\text{s}$ , duty cycle $\leq 2\%$	20	36	S	
$C_{ies}$	$V_{CE} = 25\text{ V}$ , $V_{GE} = 0\text{ V}$ , $f = 1\text{ MHz}$		2560	pF	
$C_{oes}$			210	pF	
$C_{res}$			54	pF	
$Q_g$	$I_C = 30\text{ A}$ , $V_{GE} = 15\text{ V}$ , $V_{CE} = 300\text{ V}$		100	nC	
$Q_{ge}$			15	nC	
$Q_{gc}$			36	nC	
$t_{d(on)}$	<b>Inductive load, <math>T_J = 25^\circ\text{C}</math></b> $I_C = 30\text{ A}$ , $V_{GE} = 15\text{ V}$ $V_{CE} = 400\text{ V}$ , $R_G = 3.3\ \Omega$		18	ns	
$t_{ri}$			20	ns	
$t_{d(off)}$			130	200	ns
$t_{fi}$			82	150	ns
$E_{off}$			0.4	0.8	mJ
$t_{d(on)}$	<b>Inductive load, <math>T_J = 125^\circ\text{C}</math></b> $I_C = 30\text{ A}$ , $V_{GE} = 15\text{ V}$ $V_{CE} = 400\text{ V}$ , $R_G = 3.3\ \Omega$		18	ns	
$t_{ri}$			20	ns	
$E_{on}$			0.3	mJ	
$t_{d(off)}$			240	ns	
$t_{fi}$			150	ns	
$E_{off}$			1.10	mJ	
$R_{thJC}$				0.75 K/W	
$R_{thCK}$			0.15	K/W	

### ISOPLUS 247 Outline

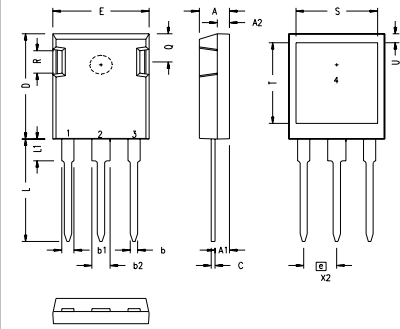

SYM	INCHES		MILLIMETERS	
	MIN	MAX	MIN	MAX
A	.190	.205	4.83	5.21
A1	.090	.100	2.29	2.54
A2	.075	.085	1.91	2.16
b	.045	.055	1.14	1.40
b1	.075	.084	1.91	2.13
b2	.115	.123	2.92	3.12
C	.024	.031	0.61	0.80
D	.819	.840	20.80	21.34
E	.620	.635	15.75	16.13
e	.215 BSC		5.45 BSC	
L	.780	.800	19.81	20.32
L1	.150	.170	3.81	4.32
O	.220	.244	5.59	6.20
R	.170	.190	4.32	4.83
S	.520	.540	13.21	13.72
T	.620	.640	15.75	16.26
U	.065	.080	1.65	2.03

- 1 - GATE
- 2 - DRAIN (COLLECTOR)
- 3 - SOURCE (EMITTER)
- 4 - NO CONNECTION

NOTE: This drawing will meet all dimensions requirement of JEDEC outline TO-247AD except screw hole.

Symbol	Test Conditions	Characteristic Values ( $T_J = 25^\circ\text{C}$ , unless otherwise specified)		
		min.	typ.	max.
$V_F$	$I_F = 30\text{ A}$ , $V_{GE} = 0\text{ V}$ , Pulse test $t \leq 300\ \mu\text{s}$ , duty cycle $d \leq 2\%$			1.6 V 2.5 V
$I_{RM}$	$I_F = 30\text{ A}$ , $V_{GE} = 0\text{ V}$ , $-di_F/dt = 100\text{ A}/\mu\text{s}$ , $T_J = 100^\circ\text{C}$ $V_R = 100\text{ V}$ , $T_J = 100^\circ\text{C}$ $I_F = 1\text{ A}$ ; $-di/dt = 100\text{ A}/\mu\text{s}$ ; $V_R = 30\text{ V}$		100	4 A ns
$t_{rr}$			25	ns
$R_{thJC}$		0.9		1.1 K/W

IXYS reserves the right to change limits, test conditions, and dimensions.

IXYS MOSFETs and IGBTs are covered by one or more of the following U.S. patents:	4,835,592	4,931,844	5,049,961	5,237,481	6,162,665	6,404,065 B1	6,683,344	6,727,585
	4,850,072	5,017,508	5,063,307	5,381,025	6,259,123 B1	6,534,343	6,710,405 B2	
	4,881,106	5,034,796	5,187,117	5,486,715	6,306,728 B1	6,583,505	6,710,463	

**Fig. 1. Output Characteristics @ 25 Deg. C**

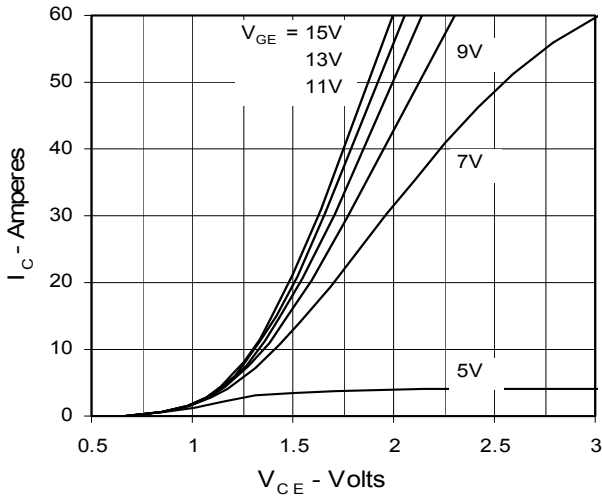

**Fig. 2. Extended Output Characteristics @ 25 deg. C**

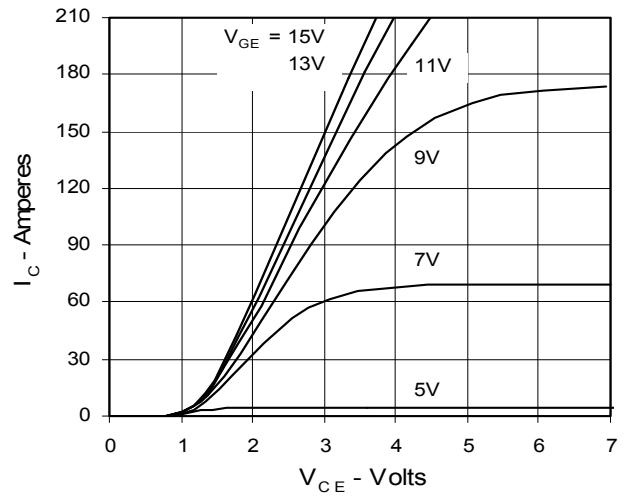

**Fig. 3. Output Characteristics @ 125 Deg. C**

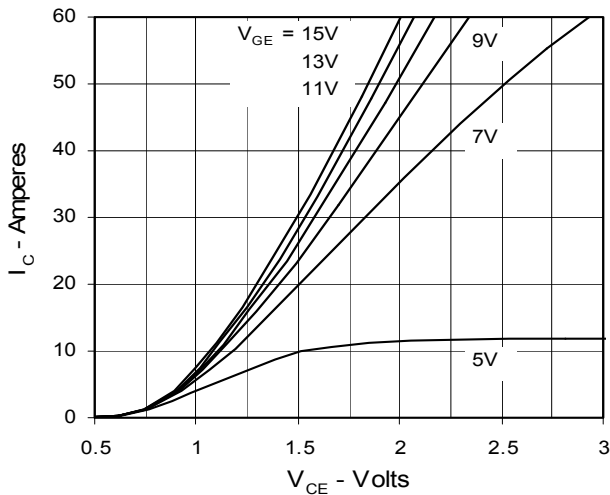

**Fig. 4. Dependence of  $V_{CE(sat)}$  on Temperature**

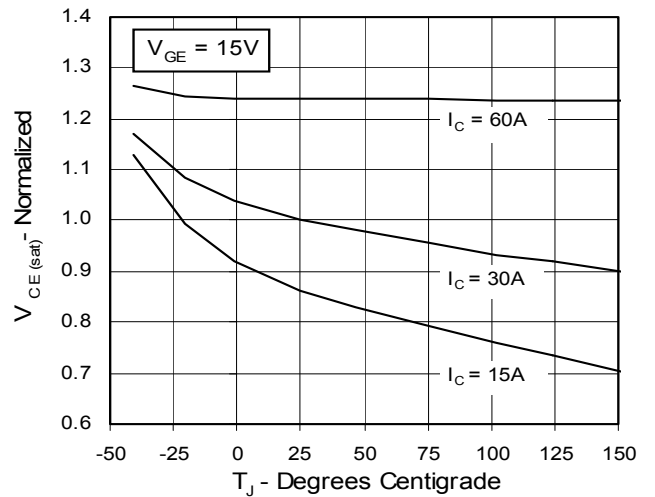

**Fig. 5. Collector-to-Emitter Voltage vs. Gate-to-Emitter voltage**

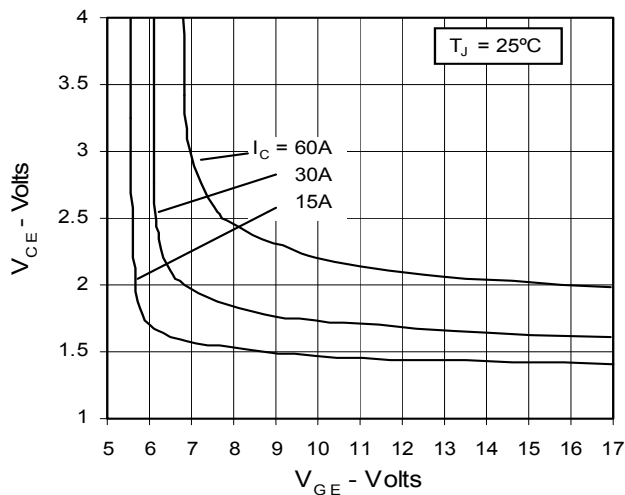

**Fig. 6. Input Admittance**

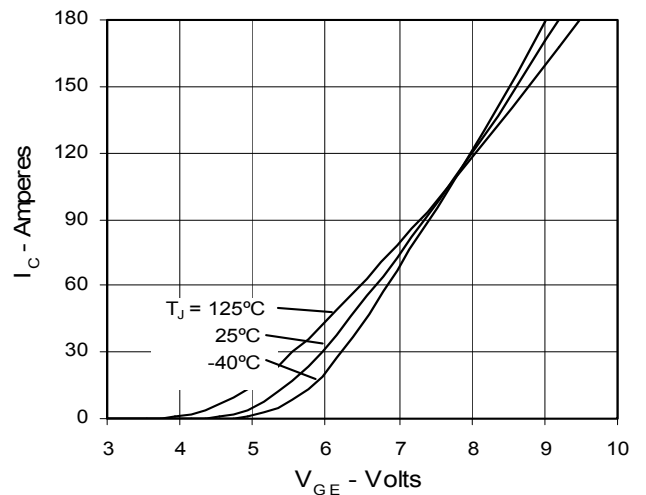

**Fig. 7. Transconductance**

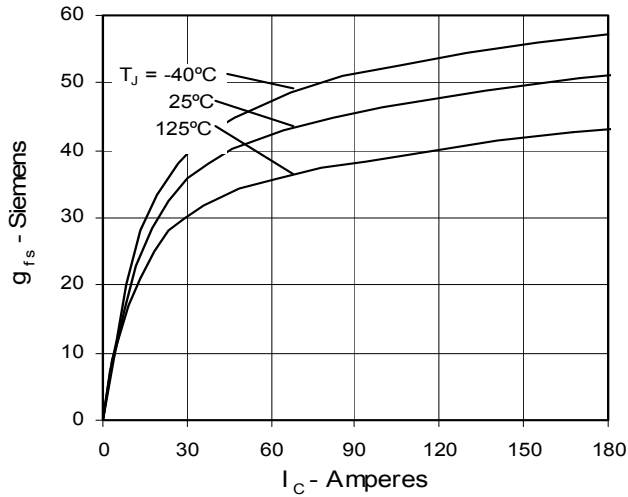

**Fig. 8. Dependence of Turn-Off Energy on  $R_G$**

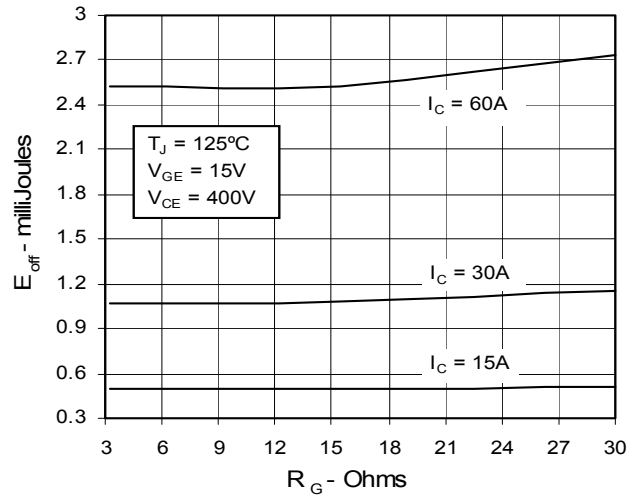

**Fig. 9. Dependence of Turn-Off Energy on  $I_C$**

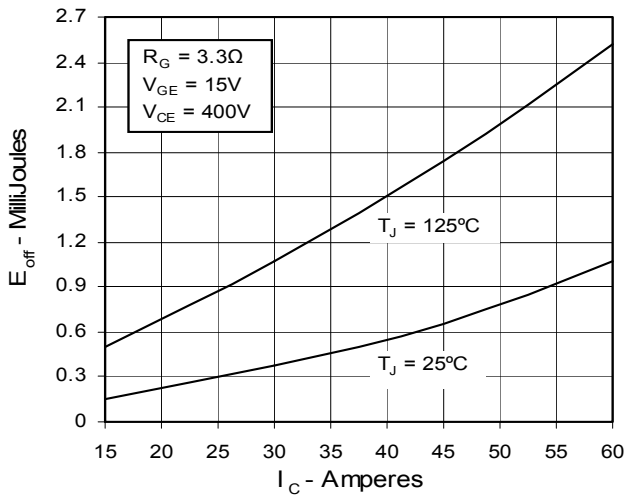

**Fig. 10. Dependence of Turn-Off Energy on Temperature**

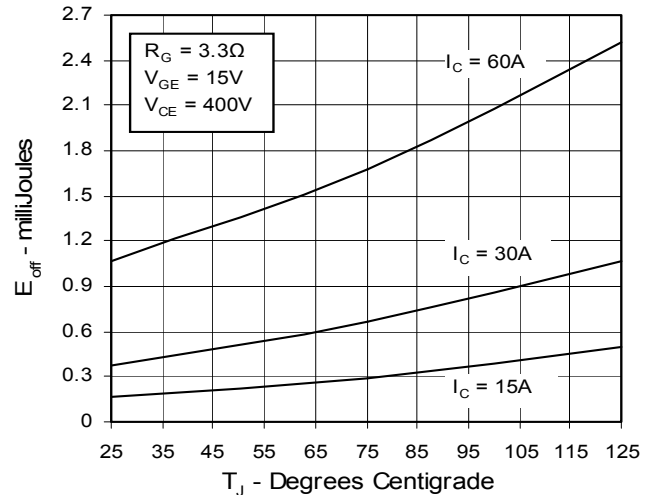

**Fig. 11. Dependence of Turn-Off Switching Time on  $R_G$**

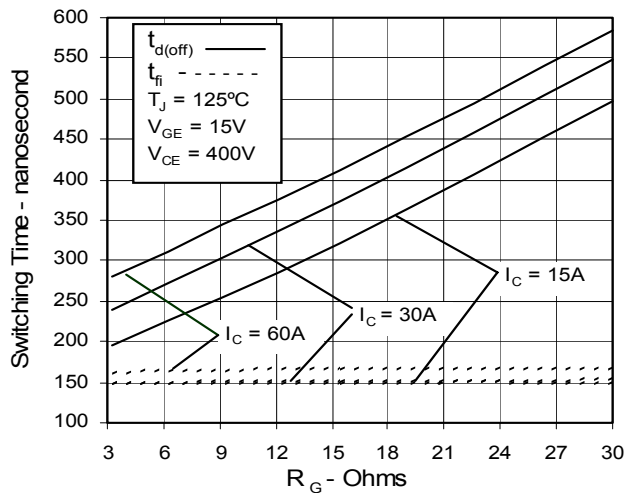

**Fig. 12. Dependence of Turn-Off Switching Time on  $I_C$**

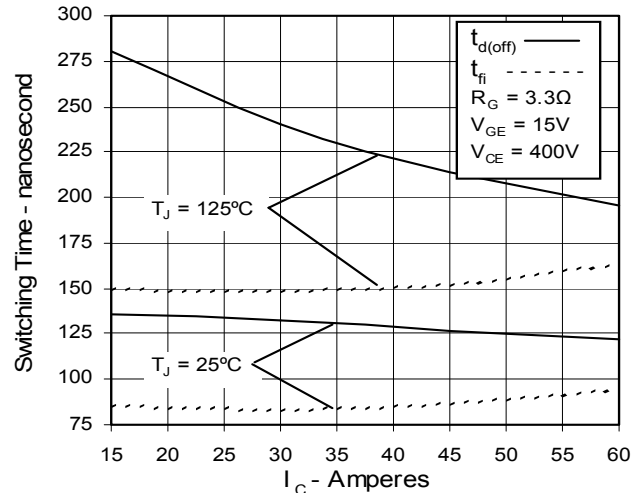

**Fig. 13. Dependence of Turn-Off Switching Time on Temperature**

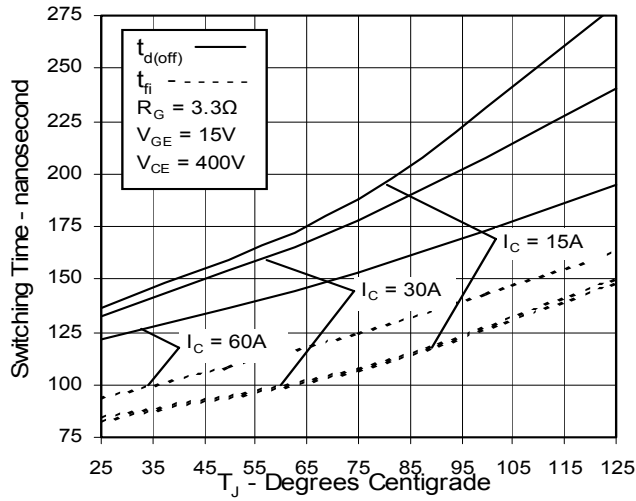

**Fig. 14. Gate Charge**

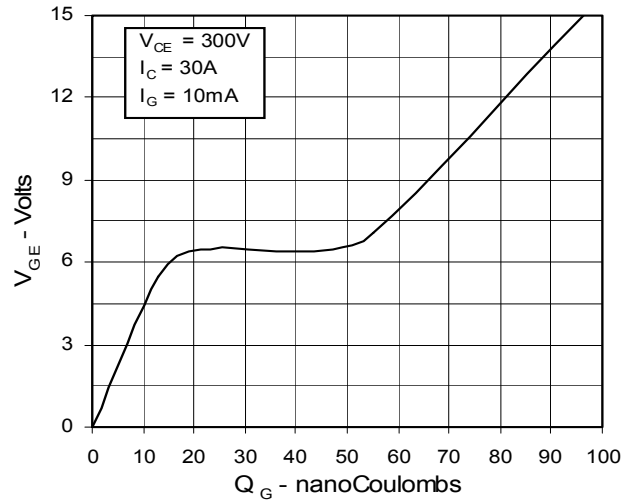

**Fig. 15. Capacitance**

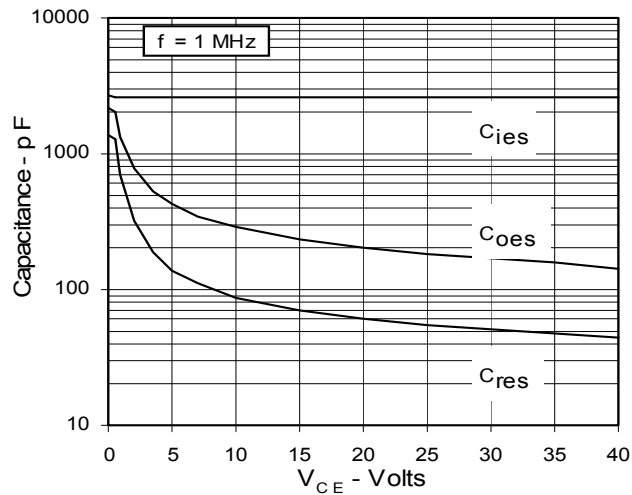

**Fig. 13. Maximum Transient Thermal Resistance**

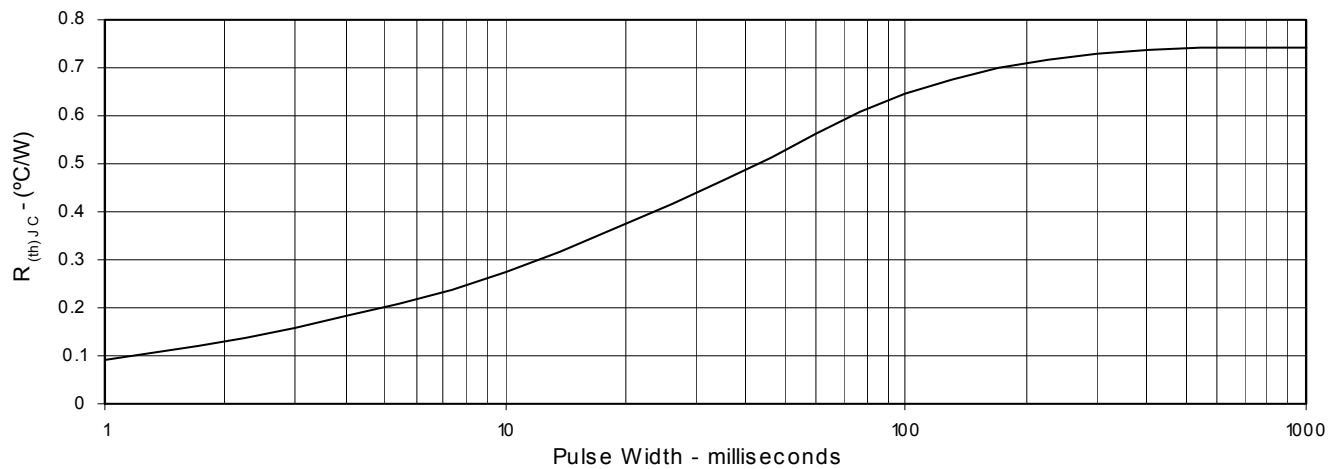

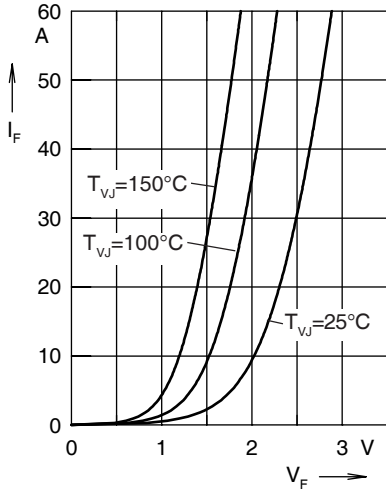

Fig. 17 Forward current  $I_F$  versus  $V_F$

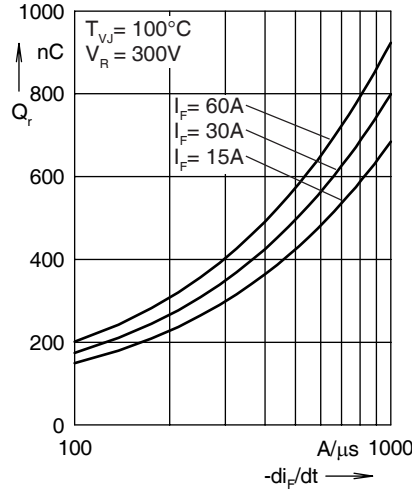

Fig. 18 Reverse recovery charge  $Q_r$  versus  $-di_F/dt$

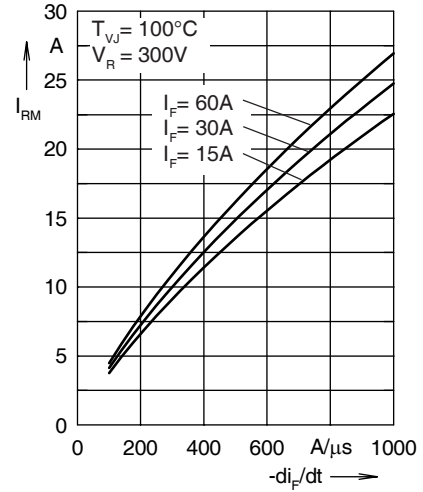

Fig. 19 Peak reverse current  $I_{RM}$  versus  $-di_F/dt$

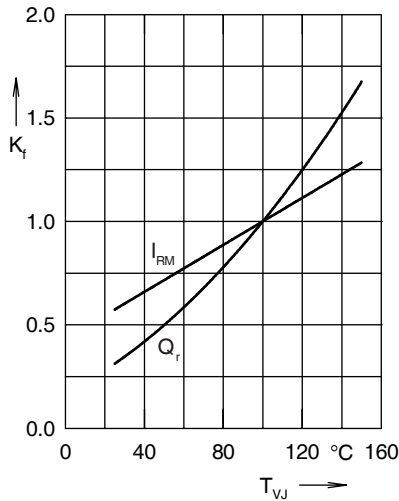

Fig. 20 Dynamic parameters  $Q_r$ ,  $I_{RM}$  versus  $T_{VJ}$

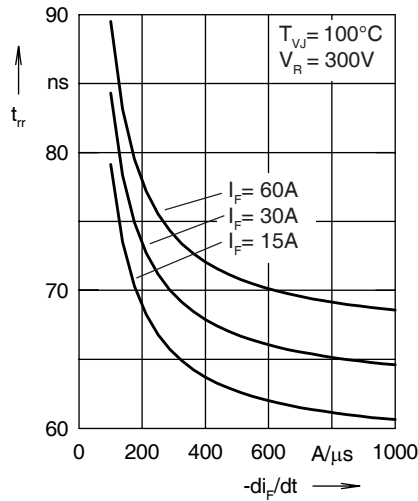

Fig. 21 Recovery time  $t_{tr}$  versus  $-di_F/dt$

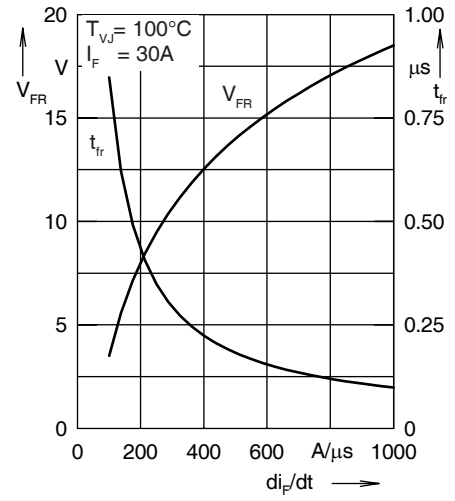

Fig. 22 Peak forward voltage  $V_{FR}$  and  $t_{tr}$  versus  $di_F/dt$

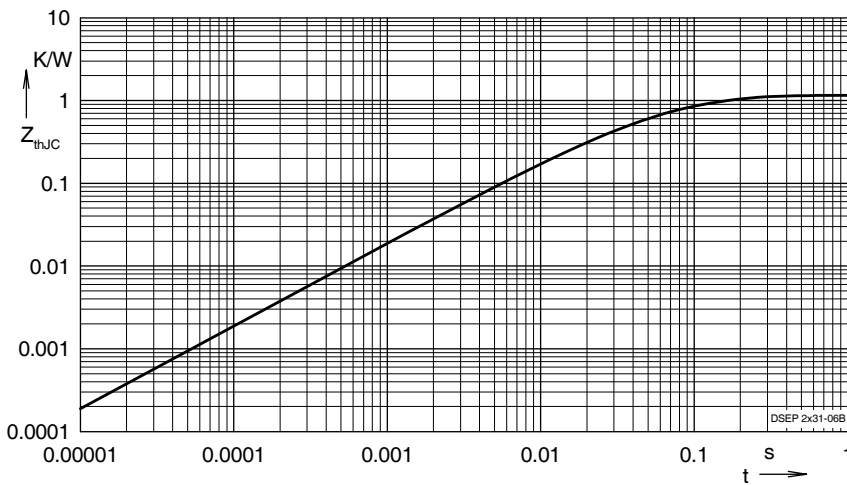

Fig. 23 Transient thermal resistance junction to case

Constants for  $Z_{thJC}$  calculation:

i	$R_{thi}$ (K/W)	$t_i$ (s)
1	0.436	0.0055
2	0.482	0.0092
3	0.117	0.0007
4	0.115	0.0418