

GenX3™ B3-Class IGBTs

IXGH72N60B3 IXGT72N60B3

Medium Speed low V_{sat} PT IGBTs 5-40 kHz Switching

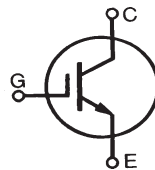

$V_{CES} = 600V$
 $I_{C110} = 72A$
 $V_{CE(sat)} \leq 1.80V$
 $t_{fi(typ)} = 90ns$

Symbol	Test Conditions	Maximum Ratings	
V_{CES}	$T_J = 25^\circ C$ to $150^\circ C$	600	V
V_{CGR}	$T_J = 25^\circ C$ to $150^\circ C$, $R_{GE} = 1M\Omega$	600	V
V_{GES}	Continuous	± 20	V
V_{GEM}	Transient	± 30	V
I_{C25}	$T_C = 25^\circ C$ (Limited by Leads)	75	A
I_{C110}	$T_C = 110^\circ C$	72	A
I_{CM}	$T_C = 25^\circ C$, 1ms	400	A
I_A	$T_C = 25^\circ C$	20	A
E_{AS}	$T_C = 25^\circ C$	200	mJ
SSOA (RBSOA)	$V_{GE} = 15V$, $T_{VJ} = 125^\circ C$, $R_G = 3\Omega$ Clamped Inductive Load	$I_{CM} = 240$ @ $V_{CE} \leq 600$	A V
P_C	$T_C = 25^\circ C$	540	W
T_J		-55 ... +150	$^\circ C$
T_{JM}		150	$^\circ C$
T_{stg}		-55 ... +150	$^\circ C$
M_d	Mounting Torque (TO-247)	1.13 / 10	Nm/lb.in.
T_L	1.6mm (0.062 in.) from Case for 10s	300	$^\circ C$
T_{SOLD}	Plastic Body for 10 seconds	260	$^\circ C$
Weight	TO-247	6	g
	TO-268	5	g

TO-247 AD (IXGH)

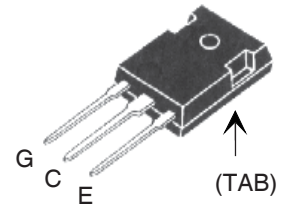

TO-268 (IXGT)

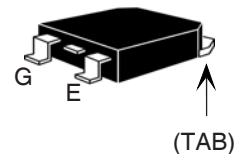

G = Gate C = Collector
 E = Emitter TAB = Collector

Features

- Optimized for Low Conduction and Switching Losses
- Square RBSOA
- Avalanche Rated
- International Standard Packages

Advantages

- High Power Density
- Low Gate Drive Requirement

Applications

- Power Inverters
- UPS
- Motor Drives
- SMPS
- PFC Circuits
- Battery Chargers
- Welding Machines
- Lamp Ballasts

Symbol	Test Conditions ($T_J = 25^\circ C$, Unless Otherwise Specified)	Characteristic Values		
		Min.	Typ.	Max.
BV_{CES}	$I_C = 250\mu A$, $V_{GE} = 0V$	600		V
$V_{GE(th)}$	$I_C = 250\mu A$, $V_{CE} = V_{GE}$	3.0		V
I_{CES}	$V_{CE} = V_{CES}$, $V_{GE} = 0V$ $T_J = 125^\circ C$			75 μA 750 μA
I_{GES}	$V_{CE} = 0V$, $V_{GE} = \pm 20V$			± 100 nA
$V_{CE(sat)}$	$I_C = 60A$, $V_{GE} = 15V$, Note 1 $T_J = 125^\circ C$	1.51 1.48	1.80	V V

Symbol	Test Conditions	Characteristic Values		
		Min.	Typ.	Max.
g_{fs}	$I_C = 60A, V_{CE} = 10V, \text{Note 1}$	50	83	S
C_{ies}	$V_{CE} = 25V, V_{GE} = 0V, f = 1MHz$		6800	pF
C_{oes}			575	pF
C_{res}			80	pF
Q_g	$I_C = 60A, V_{GE} = 15V, V_{CE} = 0.5 \cdot V_{CES}$		230	nC
Q_{ge}			40	nC
Q_{gc}			82	nC
$t_{d(on)}$	Inductive load, $T_J = 25^\circ C$ $I_C = 50A, V_{GE} = 15V$ $V_{CE} = 480V, R_G = 3\Omega$		31	ns
t_{ri}			33	ns
E_{on}			1.38	mJ
$t_{d(off)}$			150	330 ns
t_{fi}			90	160 ns
E_{off}			1.05	2.0 mJ
$t_{d(on)}$	Inductive load, $T_J = 125^\circ C$ $I_C = 50A, V_{GE} = 15V$ $V_{CE} = 480V, R_G = 3\Omega$		29	ns
t_{ri}			34	ns
E_{on}			2.70	mJ
$t_{d(off)}$			228	ns
t_{fi}			142	ns
E_{off}			2.20	mJ
R_{thJC}	(TO-247)			0.23 $^\circ C/W$
R_{thCS}			0.25	$^\circ C/W$

TO-247 AD Outline

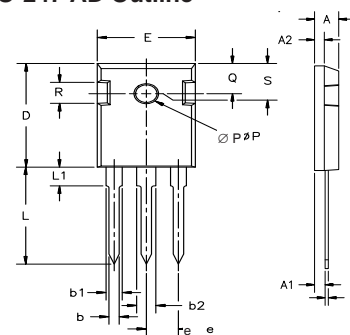

Dim.	Millimeter		Inches	
	Min.	Max.	Min.	Max.
A	4.7	5.3	.185	.209
A ₁	2.2	2.54	.087	.102
A ₂	2.2	2.6	.059	.098
b	1.0	1.4	.040	.055
b ₁	1.65	2.13	.065	.084
b ₂	2.87	3.12	.113	.123
C	.4	.8	.016	.031
D	20.80	21.46	.819	.845
E	15.75	16.26	.610	.640
e	5.20	5.72	0.205	0.225
L	19.81	20.32	.780	.800
L ₁		4.50		.177
∅P	3.55	3.65	.140	.144
Q	5.89	6.40	0.232	0.252
R	4.32	5.49	.170	.216
S	6.15	BSC	.242	BSC

TO-268 Outline

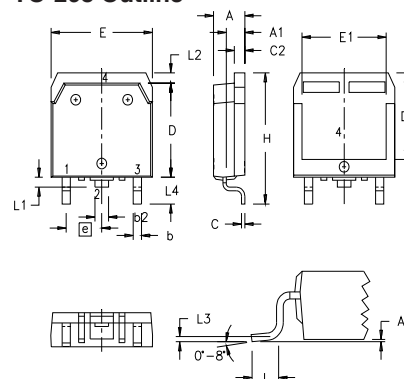

SYM	INCHES		MILLIMETERS	
	MIN	MAX	MIN	MAX
A	.193	.201	4.90	5.10
A1	.106	.114	2.70	2.90
A2	.001	.010	0.02	0.25
b	.045	.057	1.15	1.45
b2	.075	.083	1.90	2.10
C	.016	.026	0.40	0.65
C2	.057	.063	1.45	1.60
D	.543	.551	13.80	14.00
D1	.488	.500	12.40	12.70
E	.624	.632	15.85	16.05
E1	.524	.535	13.30	13.60
e	.215 BSC		5.45 BSC	
H	.736	.752	18.70	19.10
L	.094	.106	2.40	2.70
L1	.047	.055	1.20	1.40
L2	.039	.045	1.00	1.15
L3	.010 BSC		0.25 BSC	
L4	.150	.161	3.80	4.10

Note 1: Pulse Test, $t \leq 300\mu s$, Duty Cycle, $d \leq 2\%$.

IXYS Reserves the Right to Change Limits, Test Conditions, and Dimensions.

IXYS MOSFETs and IGBTs are covered by one or more of the following U.S. patents:

4,835,592	4,931,844	5,049,961	5,237,481	6,162,665	6,404,065 B1	6,683,344	6,727,585	7,005,734 B2	7,157,338B2
4,850,072	5,017,508	5,063,307	5,381,025	6,259,123 B1	6,534,343	6,710,405 B2	6,759,692	7,063,975 B2	
4,881,106	5,034,796	5,187,117	5,486,715	6,306,728 B1	6,583,505	6,710,463	6,771,478 B2	7,071,537	

Fig. 1. Output Characteristics @ 25°C

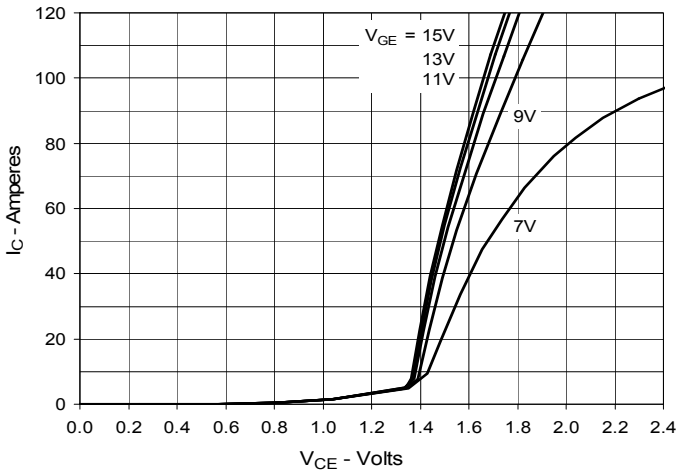

Fig. 2. Extended Output Characteristics @ 25°C

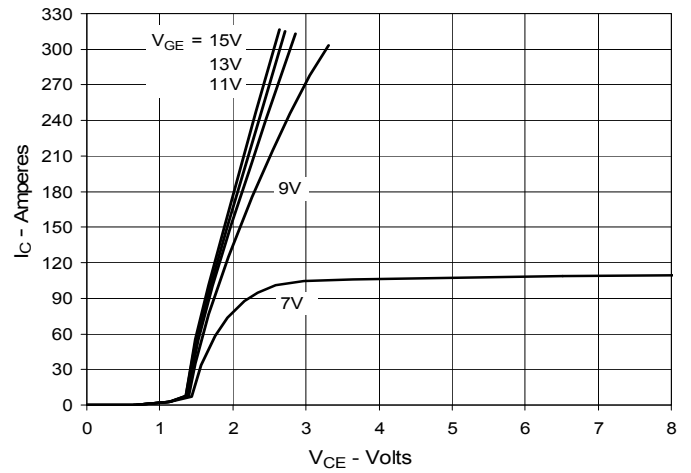

Fig. 3. Output Characteristics @ 125°C

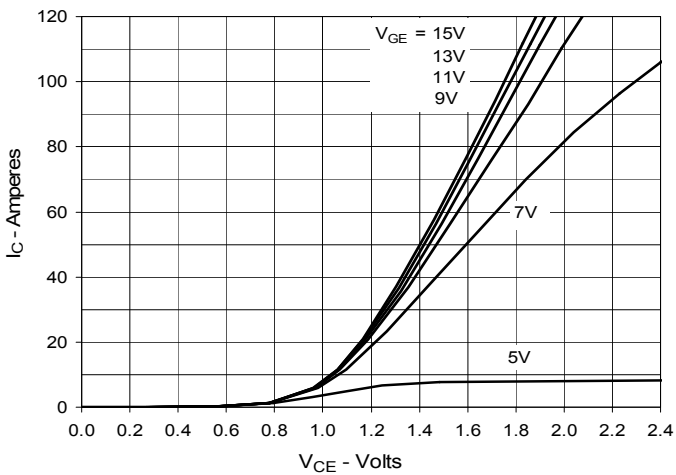

Fig. 4. Dependence of $V_{CE(sat)}$ on Junction Temperature

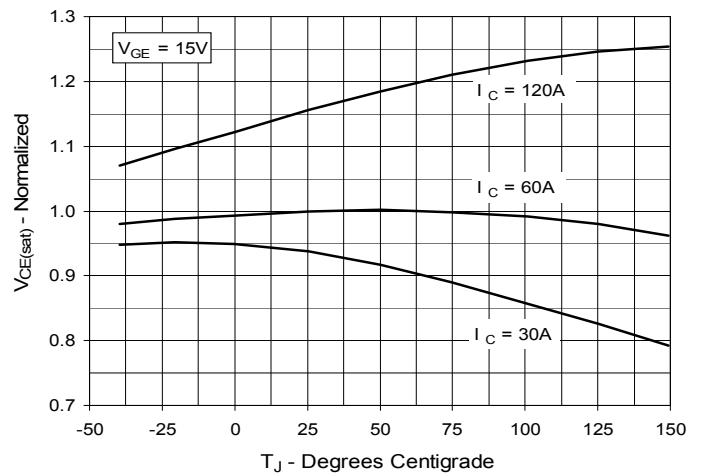

Fig. 5. Collector-to-Emitter Voltage vs. Gate-to-Emitter Voltage

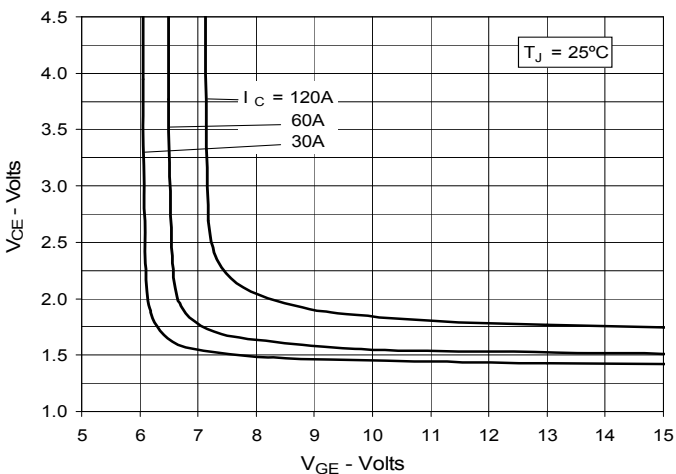

Fig. 6. Input Admittance

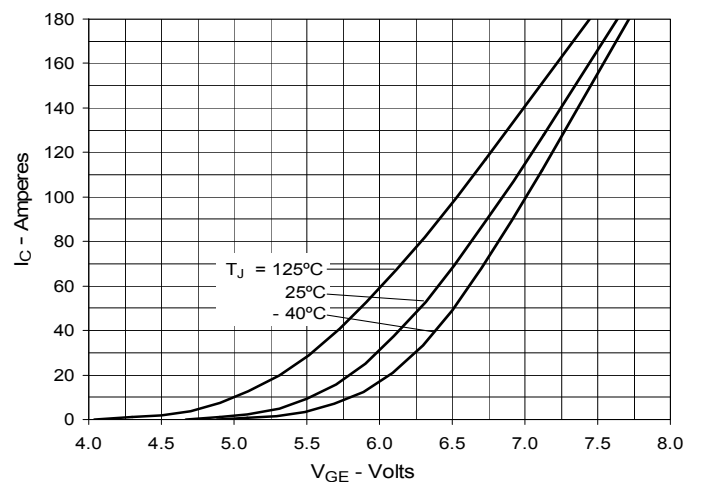

Fig. 7. Transconductance

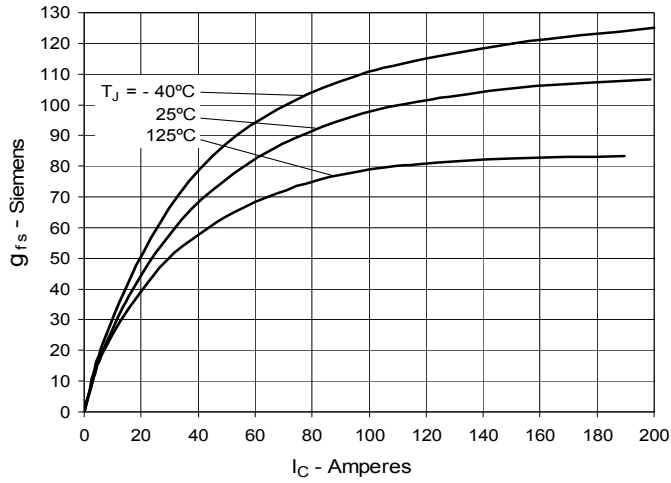

Fig. 8. Gate Charge

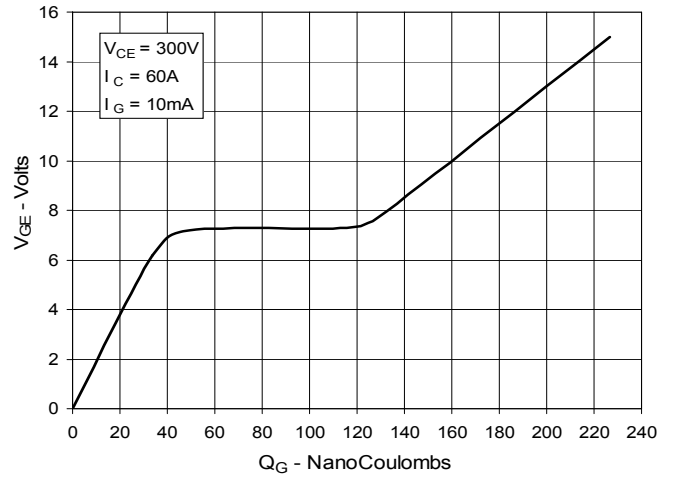

Fig. 9. Capacitance

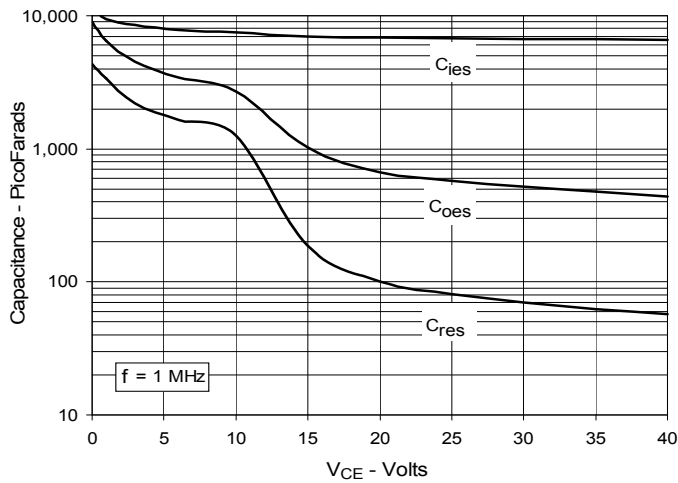

Fig. 10. Reverse-Bias Safe Operating Area

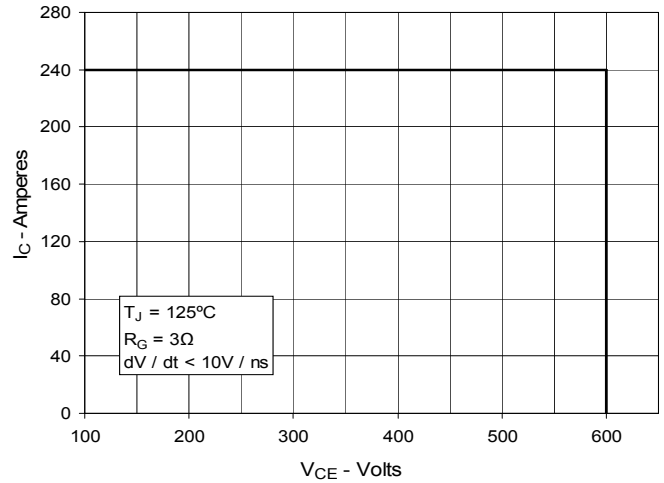
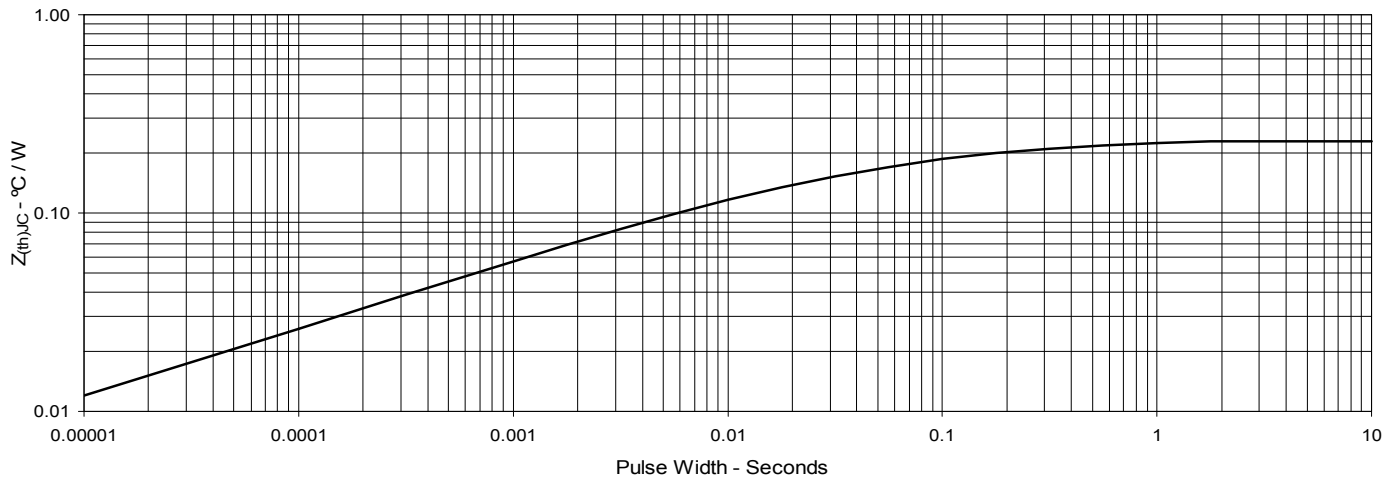

Fig. 11. Maximum Transient Thermal Impedance



IXYS Reserves the Right to Change Limits, Test Conditions, and Dimensions.

Fig. 12. Inductive Switching Energy Loss vs. Gate Resistance

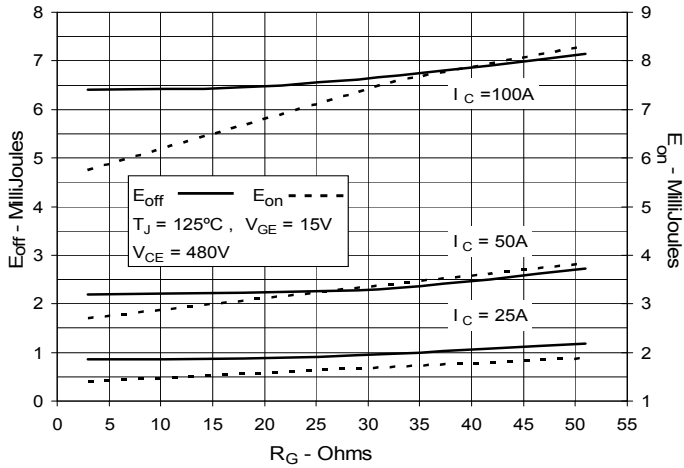

Fig. 13. Inductive Switching Energy Loss vs. Collector Current

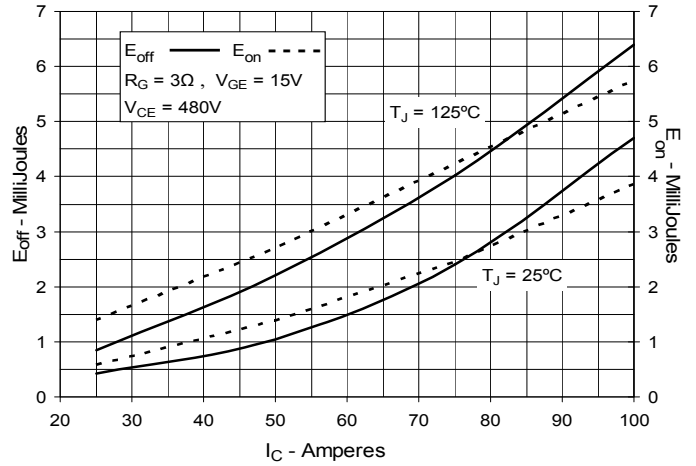

Fig. 14. Inductive Switching Energy Loss vs. Junction Temperature

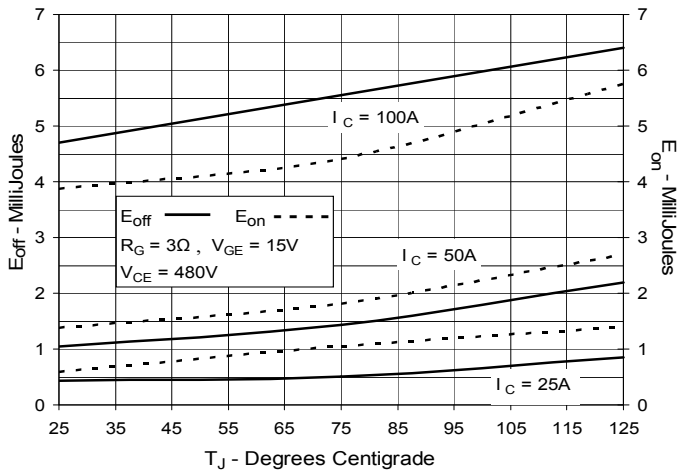

Fig. 15. Inductive Turn-off Switching Times vs. Gate Resistance

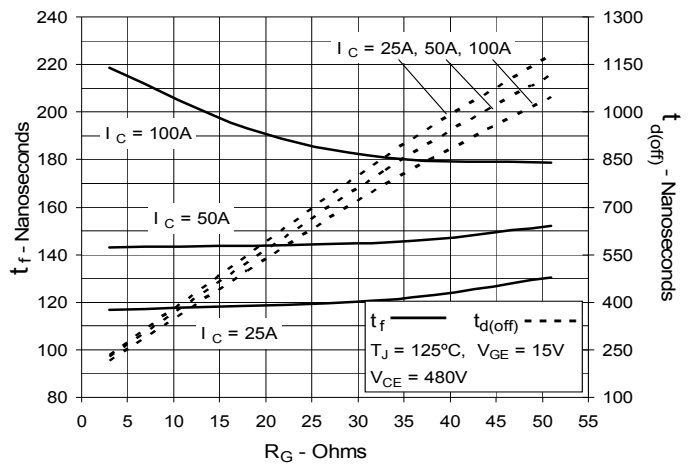

Fig. 16. Inductive Turn-off Switching Times vs. Collector Current

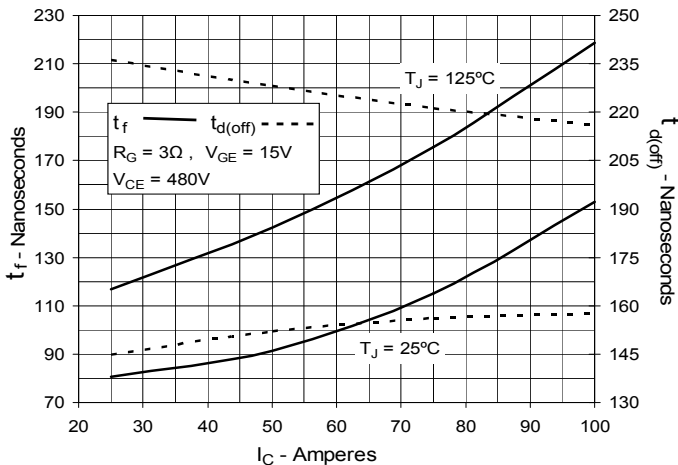

Fig. 17. Inductive Turn-off Switching Times vs. Junction Temperature

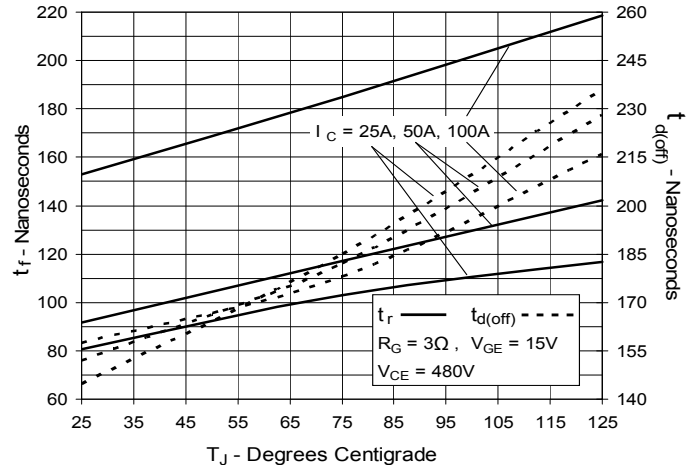

Fig. 18. Inductive Turn-on Switching Times vs. Gate Resistance

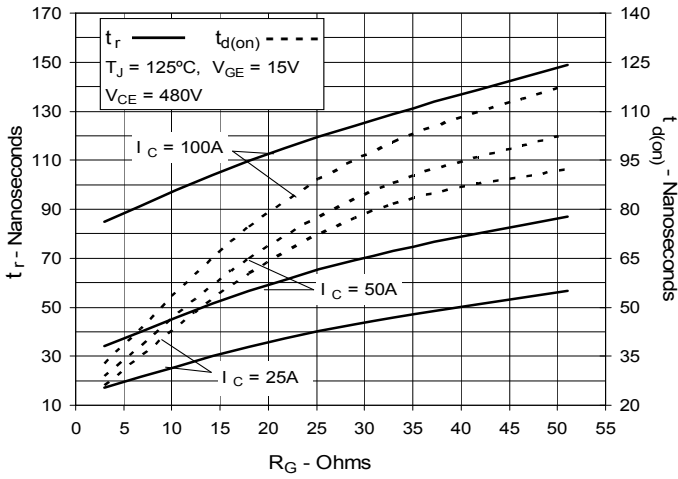

Fig. 19. Inductive Turn-on Switching Times vs. Collector Current

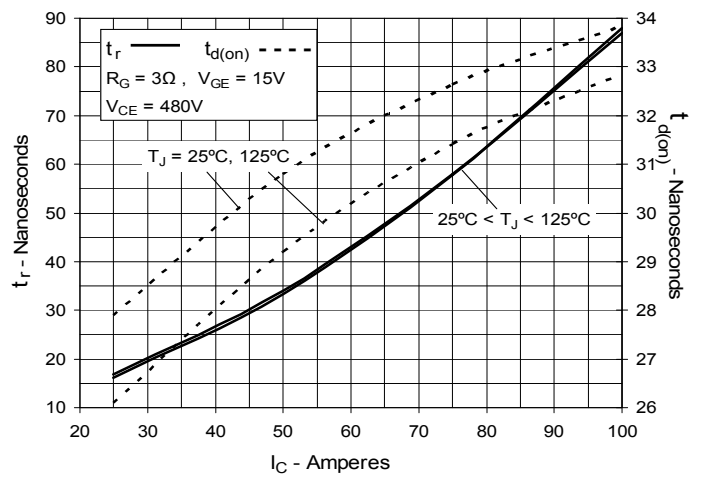

Fig. 20. Inductive Turn-on Switching Times vs. Junction Temperature

