

HiPerFAST™ IGBT

IXGH 20N60B
IXGT 20N60B

$V_{CES} = 600 \text{ V}$
 $I_{C25} = 40 \text{ A}$
 $V_{CE(sat)typ} = 1.7 \text{ V}$
 $t_{fi(typ)} = 100 \text{ ns}$

Preliminary data sheet

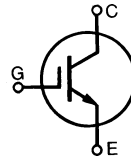

Symbol	Test Conditions	Maximum Ratings	
V_{CES}	$T_J = 25^\circ\text{C to } 150^\circ\text{C}$	600	V
V_{CGR}	$T_J = 25^\circ\text{C to } 150^\circ\text{C}; R_{GE} = 1 \text{ M}\Omega$	600	V
V_{GES}	Continuous	± 20	V
V_{GEM}	Transient	± 30	V
I_{C25}	$T_C = 25^\circ\text{C}$	40	A
I_{C90}	$T_C = 90^\circ\text{C}$	20	A
I_{CM}	$T_C = 25^\circ\text{C}, 1 \text{ ms}$	80	A
SSOA (RBSOA)	$V_{GE} = 15 \text{ V}, T_{VJ} = 125^\circ\text{C}, R_G = 22 \Omega$ Clamped inductive load, $L = 100 \mu\text{H}$	$I_{CM} = 40$ @ $0.8 V_{CES}$	A
P_C	$T_C = 25^\circ\text{C}$	150	W
T_J		-55 ... +150	$^\circ\text{C}$
T_{JM}		150	$^\circ\text{C}$
T_{stg}		-55 ... +150	$^\circ\text{C}$
Maximum Lead and Tab temperature for soldering 1.6 mm (0.062 in.) from case for 10 s		300	$^\circ\text{C}$
M_d	Mounting torque, TO-247 AD	1.13/10	Nm/lb.in.
Weight	TO-247	6	g
	TO-268	4	g

TO-268 (D3) (IXGT)

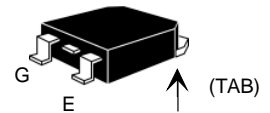

TO-247 AD (IXGH)

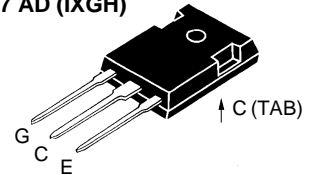

G = Gate, C = Collector,
E = Emitter, TAB = Collector

Features

- International standard packages
JEDEC TO-268 surface mountable and JEDEC TO-247 AD
- High current handling capability
- Latest generation HDMOST™ process
- MOS Gate turn-on
- drive simplicity

Applications

- AC motor speed control
- DC servo and robot drives
- DC choppers
- Uninterruptible power supplies (UPS)
- Switched-mode and resonant-mode power supplies

Advantages

- Space savings (two devices in one package)
- High power density
- Suitable for surface mounting
- Switching speed for high frequency applications
- Easy to mount with 1 screw, TO-247 (isolated mounting screw hole)

Symbol	Test Conditions	Characteristic Values ($T_J = 25^\circ\text{C}$, unless otherwise specified)		
		min.	typ.	max.
BV_{CES}	$I_C = 250 \mu\text{A}, V_{GE} = 0 \text{ V}$	600		V
$V_{GE(th)}$	$I_C = 250 \mu\text{A}, V_{CE} = V_{GE}$	2.5		V
I_{CES}	$V_{CE} = 0.8 \cdot V_{CES}$ $V_{GE} = 0 \text{ V}$			$T_J = 25^\circ\text{C}$ $T_J = 125^\circ\text{C}$ 200 μA 1 mA
I_{GES}	$V_{CE} = 0 \text{ V}, V_{GE} = \pm 20 \text{ V}$			$\pm 100 \text{ nA}$
$V_{CE(sat)}$	$I_C = I_{C90}, V_{GE} = 15 \text{ V}$	1.7	2.0	V

Symbol	Test Conditions	Characteristic Values ($T_J = 25^\circ\text{C}$, unless otherwise specified)		
		min.	typ.	max.
g_{fs}	$I_C = I_{C90}$; $V_{CE} = 10\text{ V}$, Pulse test, $t \leq 300\ \mu\text{s}$, duty cycle $\leq 2\%$	9	17	S
C_{ies} C_{oes} C_{res}	$V_{CE} = 25\text{ V}$, $V_{GE} = 0\text{ V}$, $f = 1\text{ MHz}$		1500	pF
			175	pF
			40	pF
Q_g Q_{ge} Q_{gc}	$I_C = I_{C90}$; $V_{GE} = 15\text{ V}$, $V_{CE} = 0.5 V_{CES}$		90	nC
			11	nC
			30	nC
$t_{d(on)}$ t_{ri} E_{on}	Inductive load, $T_J = 25^\circ\text{C}$ $I_C = I_{C90}$, $V_{GE} = 15\text{ V}$, $L = 100\ \mu\text{H}$, $V_{CE} = 0.8 V_{CES}$, $R_G = R_{off} = 10\ \Omega$		15	ns
			35	ns
			0.15	mJ
$t_{d(off)}$ t_{fi} E_{off}	Note 1		150	200 ns
			100	150 ns
			0.7	1.0 mJ
$t_{d(on)}$ t_{ri} E_{on}	Inductive load, $T_J = 125^\circ\text{C}$ $I_C = I_{C90}$, $V_{GE} = 15\text{ V}$, $L = 100\ \mu\text{H}$		15	ns
			35	ns
			0.15	mJ
$t_{d(off)}$ t_{fi} E_{off}	$V_{CE} = 0.8 V_{CES}$, $R_G = R_{off} = 10\ \Omega$ Note 1		220	ns
			140	ns
			1.2	mJ
R_{thJC} R_{thCK}			0.83	K/W
		0.25		K/W

Note 1: Switching times may increase for $V_{CE}(\text{Clamp}) > 0.8 \cdot V_{CES}$, higher T_J or increased R_G

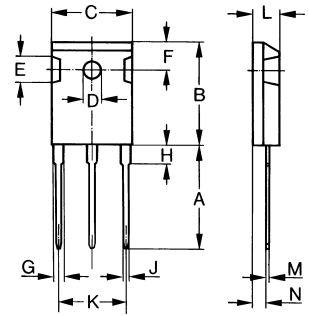
TO-247 AD (IXGH) Outline

Dim.	Millimeter		Inches	
	Min.	Max.	Min.	Max.
A	19.81	20.32	0.780	0.800
B	20.80	21.46	0.819	0.845
C	15.75	16.26	0.610	0.640
D	3.55	3.65	0.140	0.144
E	4.32	5.49	0.170	0.216
F	5.4	6.2	0.212	0.244
G	1.65	2.13	0.065	0.084
H	-	4.5	-	0.177
J	1.0	1.4	0.040	0.055
K	10.8	11.0	0.426	0.433
L	4.7	5.3	0.185	0.209
M	0.4	0.8	0.016	0.031
N	1.5	2.49	0.087	0.102

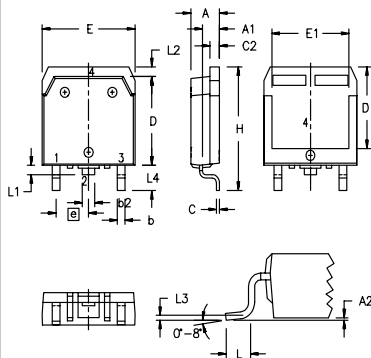
TO-268AA (D³ PAK)

Dim.	Millimeter		Inches	
	Min.	Max.	Min.	Max.
A	4.9	5.1	.193	.201
A ₁	2.7	2.9	.106	.114
A ₂	.02	.25	.001	.010
b	1.15	1.45	.045	.057
b ₂	1.9	2.1	.75	.83
C	.4	.65	.016	.026
D	13.80	14.00	.543	.551
E	15.85	16.05	.624	.632
E ₁	13.3	13.6	.524	.535
e	5.45 BSC		.215 BSC	
H	18.70	19.10	.736	.752
L	2.40	2.70	.094	.106
L ₁	1.20	1.40	.047	.055
L ₂	1.00	1.15	.039	.045
L ₃	0.25 BSC		.010 BSC	
L ₄	3.80	4.10	.150	.161

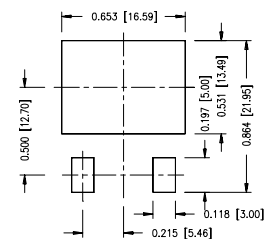
Min. Recommended Footprint

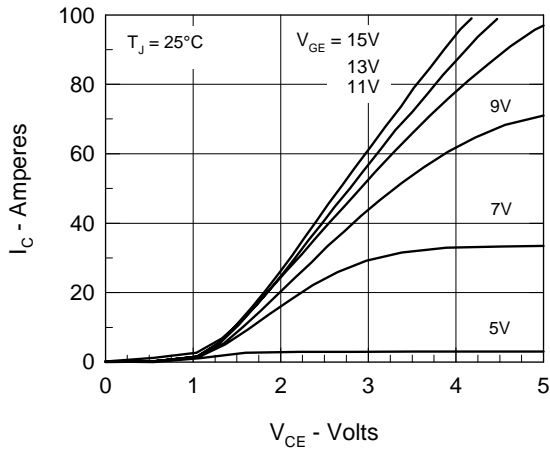

Fig. 1. Output Characteristics

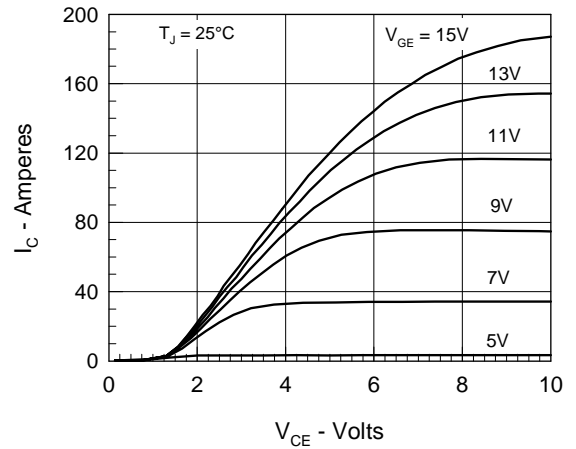

Fig. 2. Extended Output Characteristics

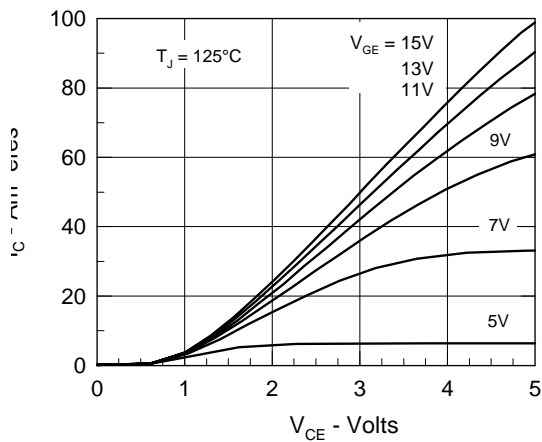

Fig. 3. High Temperature Output Characteristics

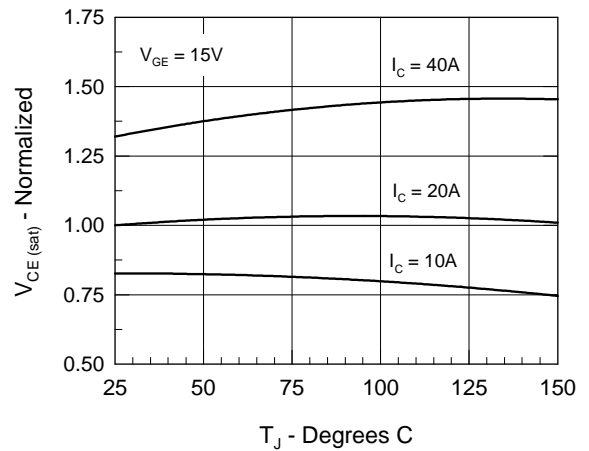
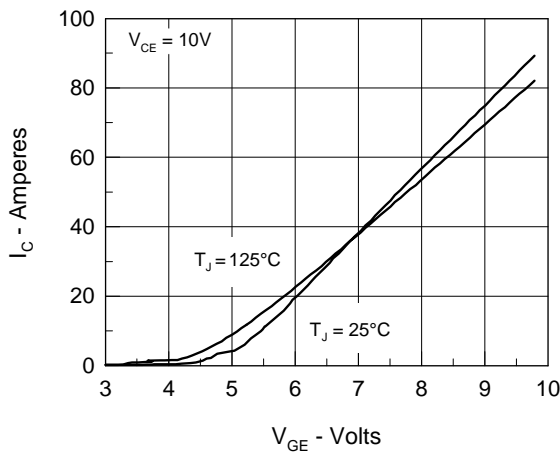

 Fig. 4. Temperature Dependence of $V_{CE(sat)}$

Fig. 5. Admittance Curves

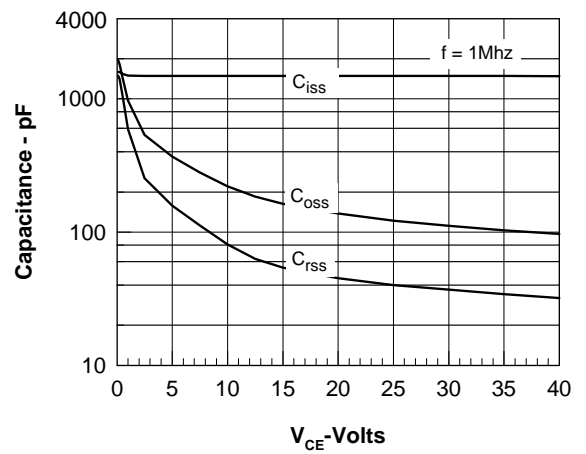

Fig. 6. Capacitance Curves

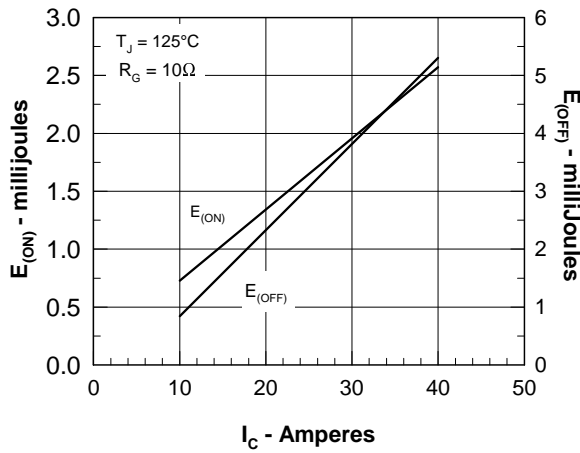

Fig. 7. Dependence of E_{ON} and E_{OFF} on I_C .

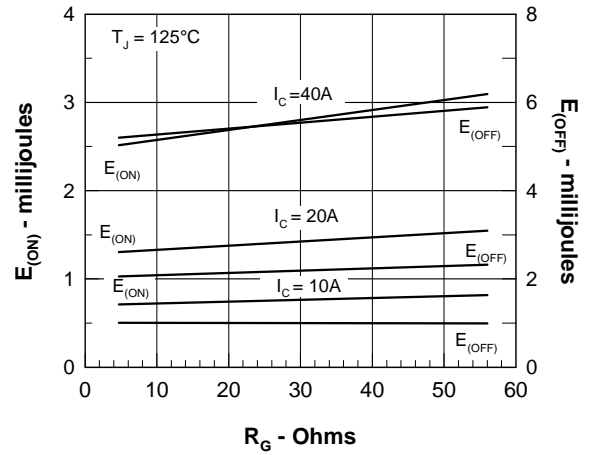

Fig. 8. Dependence of E_{ON} and E_{OFF} on R_G .

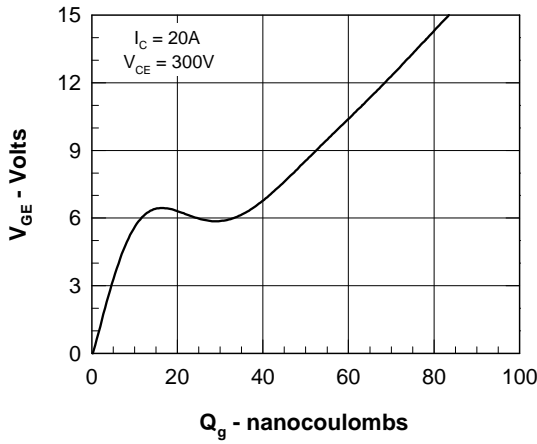

Fig. 9. Gate Charge

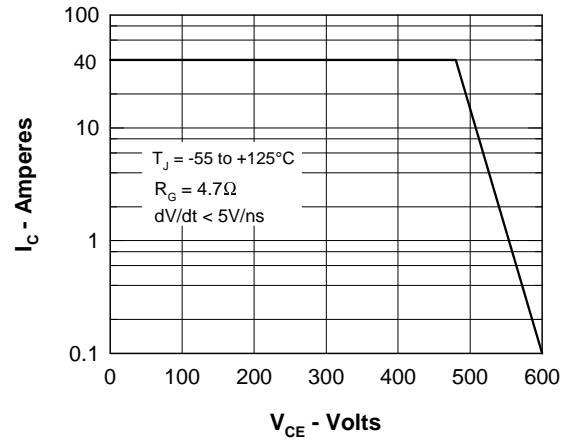

Fig. 10. Turn-off Safe Operating Area

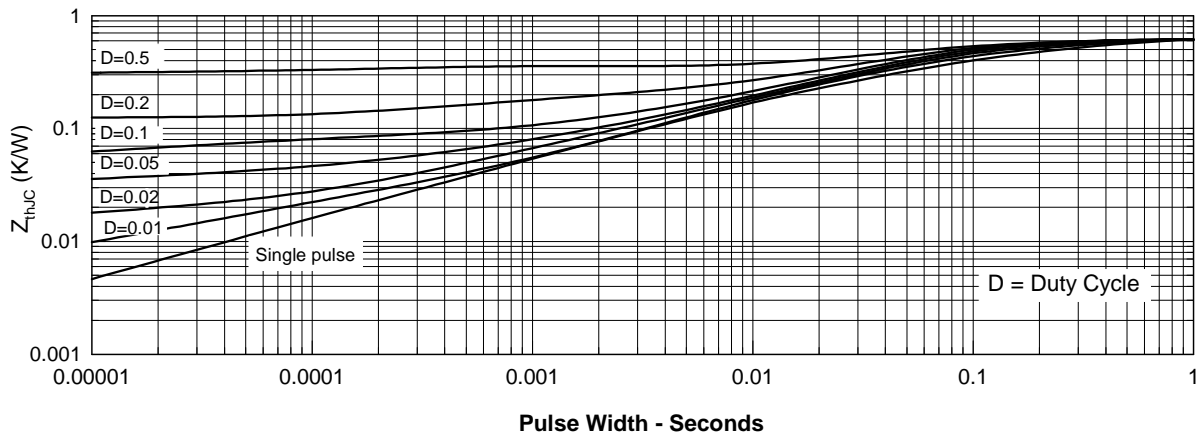

Fig. 11. IGBT Transient Thermal Resistance Junction-to-Case