

IRG4PC40KDPbF

INSULATED GATE BIPOLAR TRANSISTOR WITH
 ULTRAFAST SOFT RECOVERY DIODE

Short Circuit Rated
 UltraFast IGBT

Features

- Short Circuit Rated UltraFast: Optimized for high operating frequencies >5.0 kHz , and Short Circuit Rated to 10 μ s @ 125°C, $V_{GE} = 15V$
- Generation 4 IGBT design provides tighter parameter distribution and higher efficiency than Generation 3
- IGBT co-packaged with HEXFRED™ ultrafast, ultra-soft-recovery anti-parallel diodes for use in bridge configurations
- Industry standard TO-247AC package
- Lead-Free

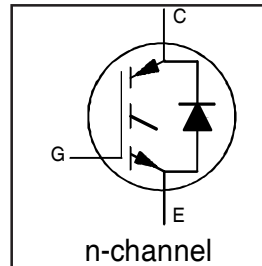

$V_{CES} = 600V$
$V_{CE(on)} \text{ typ.} = 2.1V$
@ $V_{GE} = 15V, I_C = 25A$

Benefits

- Generation 4 IGBTs offer highest efficiencies available
- HEXFRED diodes optimized for performance with IGBTs. Minimized recovery characteristics require less/no snubbing
- Designed to be a "drop-in" replacement for equivalent industry-standard Generation 3 IR IGBTs

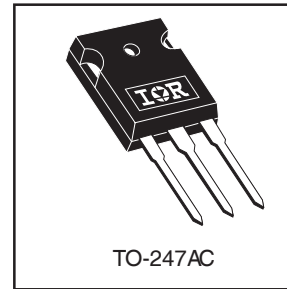

Absolute Maximum Ratings

	Parameter	Max.	Units
V_{CES}	Collector-to-Emitter Voltage	600	V
$I_C @ T_C = 25^\circ C$	Continuous Collector Current	42	A
$I_C @ T_C = 100^\circ C$	Continuous Collector Current	25	
I_{CM}	Pulsed Collector Current ①	84	
I_{LM}	Clamped Inductive Load Current ②	84	
$I_F @ T_C = 100^\circ C$	Diode Continuous Forward Current	15	
I_{FM}	Diode Maximum Forward Current	84	
t_{sc}	Short Circuit Withstand Time	10	μ s
V_{GE}	Gate-to-Emitter Voltage	± 20	V
$P_D @ T_C = 25^\circ C$	Maximum Power Dissipation	160	W
$P_D @ T_C = 100^\circ C$	Maximum Power Dissipation	65	
T_J	Operating Junction and	-55 to +150	$^\circ C$
T_{STG}	Storage Temperature Range		
	Soldering Temperature, for 10 sec.	300 (0.063 in. (1.6mm) from case)	
	Mounting Torque, 6-32 or M3 Screw.	10 lbf·in (1.1 N·m)	

Thermal Resistance

	Parameter	Min.	Typ.	Max.	Units
$R_{\theta JC}$	Junction-to-Case - IGBT	---	---	0.77	$^\circ C/W$
$R_{\theta JC}$	Junction-to-Case - Diode	---	---	1.7	
$R_{\theta CS}$	Case-to-Sink, flat, greased surface	---	0.24	---	
$R_{\theta JA}$	Junction-to-Ambient, typical socket mount	---	---	40	
Wt	Weight	---	6 (0.21)	---	g (oz)

IRG4PC40KDPbF

International
IR Rectifier

Electrical Characteristics @ T_J = 25°C (unless otherwise specified)

	Parameter	Min.	Typ.	Max.	Units	Conditions
V _{(BR)CES}	Collector-to-Emitter Breakdown Voltage ^③	600	—	—	V	V _{GE} = 0V, I _C = 250μA
ΔV _{(BR)CES} /ΔT _J	Temperature Coeff. of Breakdown Voltage	—	0.46	—	V/°C	V _{GE} = 0V, I _C = 1.0mA
V _{CE(on)}	Collector-to-Emitter Saturation Voltage	—	2.10	2.6	V	I _C = 25A V _{GE} = 15V
		—	2.70	—		I _C = 42A See Fig. 2, 5
		—	2.14	—		I _C = 25A, T _J = 150°C
V _{GE(th)}	Gate Threshold Voltage	3.0	—	6.0		V _{CE} = V _{GE} , I _C = 250μA
ΔV _{GE(th)} /ΔT _J	Temperature Coeff. of Threshold Voltage	—	-13	—	mV/°C	V _{CE} = V _{GE} , I _C = 250μA
g _{fe}	Forward Transconductance ^④	7.0	14	—	S	V _{CE} = 100V, I _C = 25A
I _{CES}	Zero Gate Voltage Collector Current	—	—	250	μA	V _{GE} = 0V, V _{CE} = 600V
		—	—	3500		V _{GE} = 0V, V _{CE} = 600V, T _J = 150°C
V _{FM}	Diode Forward Voltage Drop	—	1.3	1.7	V	I _C = 15A See Fig. 13
		—	1.2	1.6		I _C = 15A, T _J = 150°C
I _{GES}	Gate-to-Emitter Leakage Current	—	—	±100	nA	V _{GE} = ±20V

Switching Characteristics @ T_J = 25°C (unless otherwise specified)

	Parameter	Min.	Typ.	Max.	Units	Conditions
Q _g	Total Gate Charge (turn-on)	—	120	180	nC	I _C = 25A
Q _{ge}	Gate - Emitter Charge (turn-on)	—	16	24		V _{CC} = 400V See Fig.8
Q _{gc}	Gate - Collector Charge (turn-on)	—	51	77		V _{GE} = 15V
t _{d(on)}	Turn-On Delay Time	—	53	—	ns	T _J = 25°C
t _r	Rise Time	—	33	—		I _C = 25A, V _{CC} = 480V
t _{d(off)}	Turn-Off Delay Time	—	110	160		V _{GE} = 15V, R _G = 10Ω
t _f	Fall Time	—	100	150		Energy losses include "tail"
E _{on}	Turn-On Switching Loss	—	0.95	—	mJ	See Fig. 9,10,14
E _{off}	Turn-Off Switching Loss	—	0.76	—		
E _{ts}	Total Switching Loss	—	1.71	2.3		
t _{sc}	Short Circuit Withstand Time	10	—	—	μs	V _{CC} = 360V, T _J = 125°C V _{GE} = 15V, R _G = 10Ω, V _{CPK} < 500V
t _{d(on)}	Turn-On Delay Time	—	52	—	ns	T _J = 150°C,
t _r	Rise Time	—	37	—		I _C = 25A, V _{CC} = 480V
t _{d(off)}	Turn-Off Delay Time	—	220	—		V _{GE} = 15V, R _G = 10Ω
t _f	Fall Time	—	140	—		Energy losses include "tail"
E _{ts}	Total Switching Loss	—	2.67	—	mJ	See Fig. 11,14
L _E	Internal Emitter Inductance	—	13	—	nH	Measured 5mm from package
C _{ies}	Input Capacitance	—	1600	—	pF	V _{GE} = 0V
C _{oes}	Output Capacitance	—	130	—		V _{CC} = 30V See Fig. 7
C _{res}	Reverse Transfer Capacitance	—	55	—		f = 1.0MHz
t _{rr}	Diode Reverse Recovery Time	—	42	60	ns	T _J = 25°C See Fig. 14
		—	74	120		T _J = 125°C
I _{rr}	Diode Peak Reverse Recovery Current	—	4.0	6.0	A	T _J = 25°C See Fig. 15
		—	6.5	10		T _J = 125°C
Q _{rr}	Diode Reverse Recovery Charge	—	80	180	nC	T _J = 25°C See Fig. 16
		—	220	600		T _J = 125°C
di _(rec) /dt	Diode Peak Rate of Fall of Recovery During t _b	—	188	—	A/μs	T _J = 25°C See Fig. 17
		—	160	—		T _J = 125°C

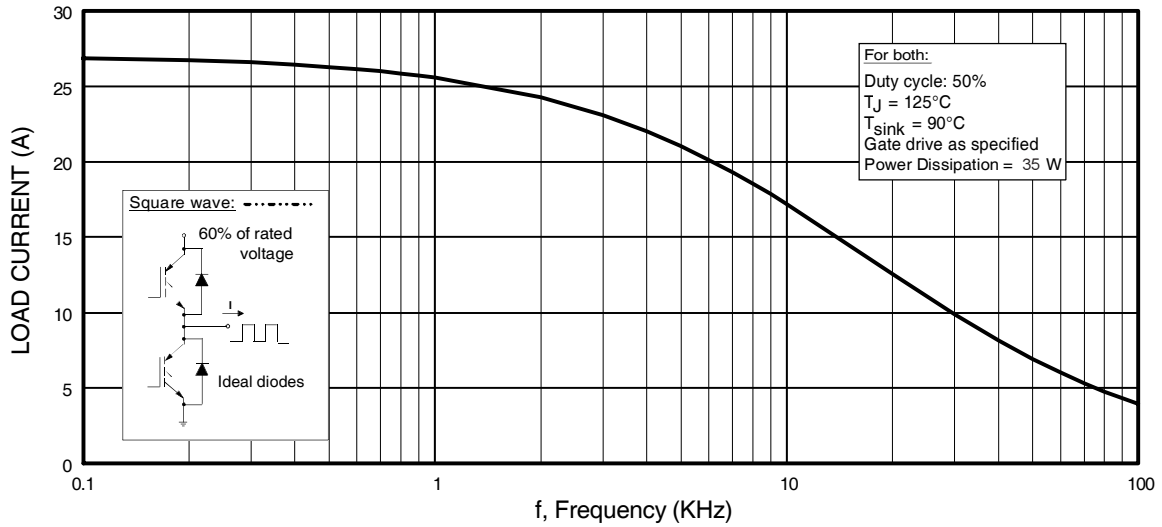

Fig. 1 - Typical Load Current vs. Frequency
 (Load Current = I_{RMS} of fundamental)

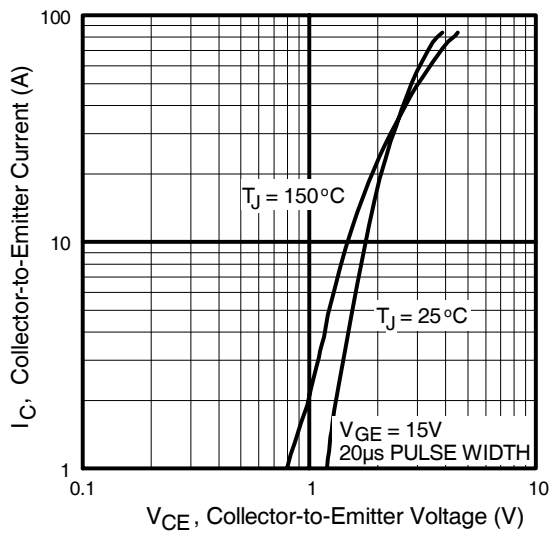

Fig. 2 - Typical Output Characteristics

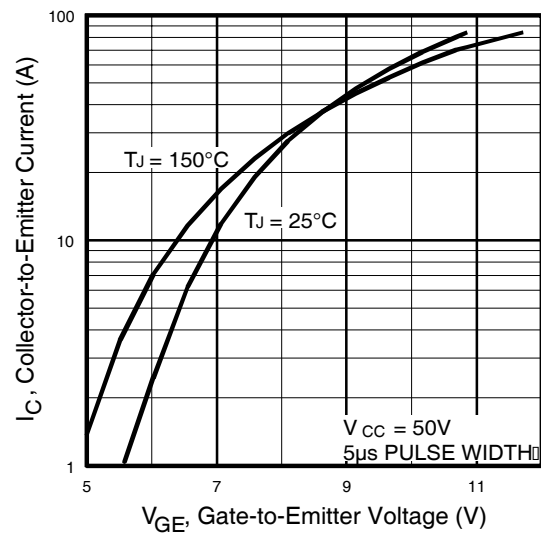

Fig. 3 - Typical Transfer Characteristics

IRG4PC40KDPbF

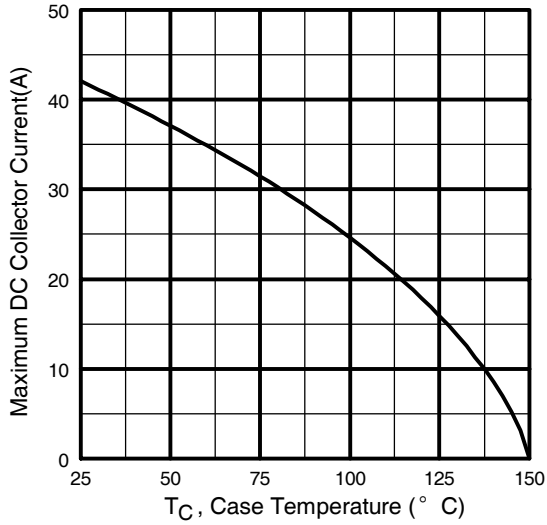

Fig. 4 - Maximum Collector Current vs. Case Temperature

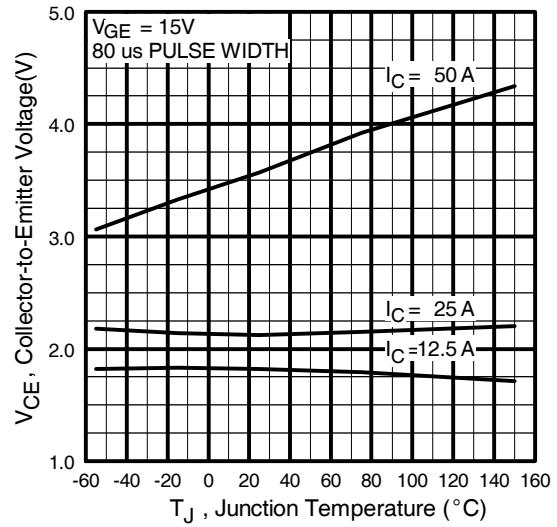

Fig. 5 - Typical Collector-to-Emitter Voltage vs. Junction Temperature

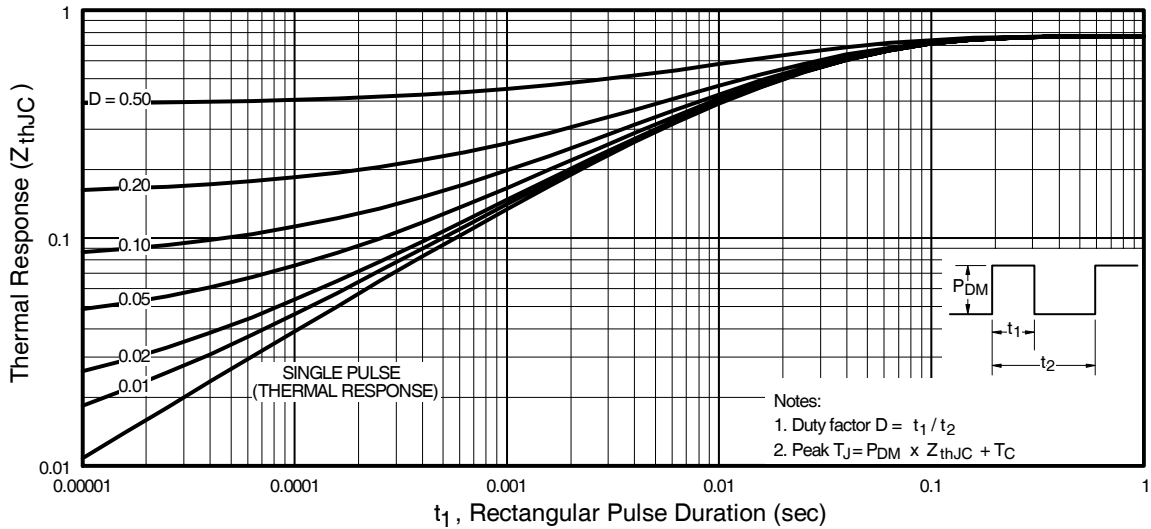

Fig. 6 - Maximum Effective Transient Thermal Impedance, Junction-to-Case

IRG4PC40KDPbF

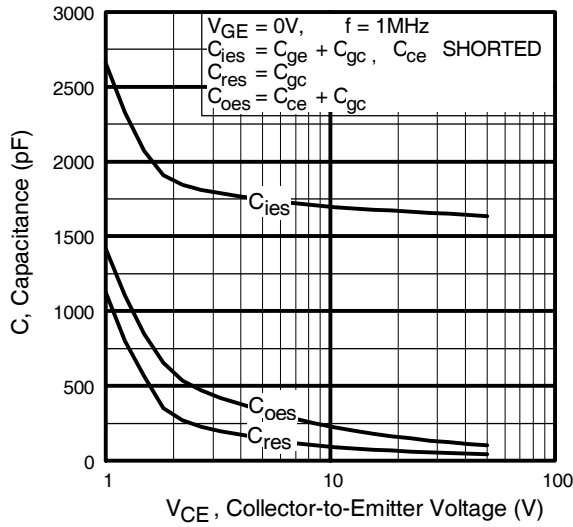

Fig. 7 - Typical Capacitance vs. Collector-to-Emitter Voltage

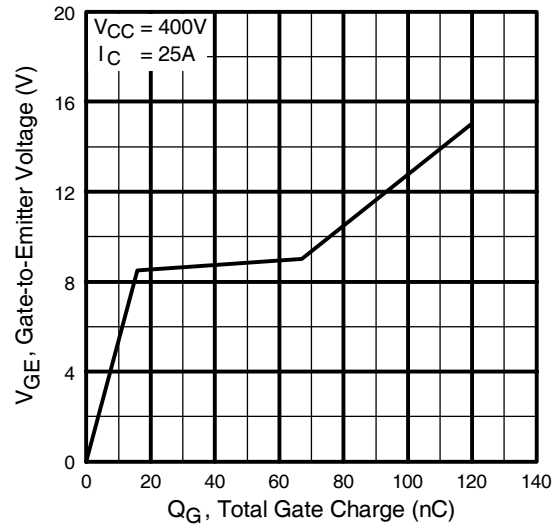

Fig. 8 - Typical Gate Charge vs. Gate-to-Emitter Voltage

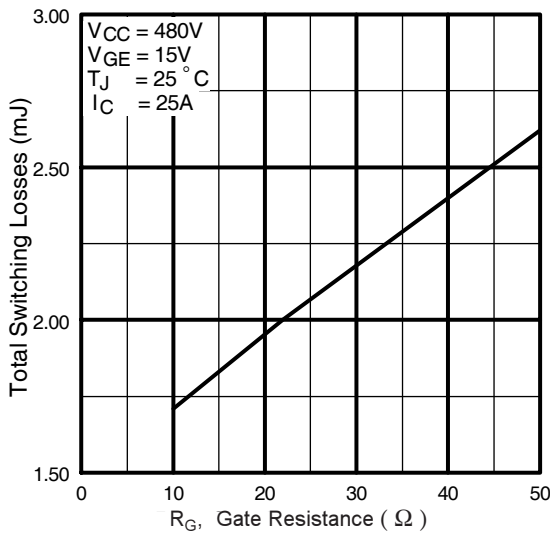

Fig. 9 - Typical Switching Losses vs. Gate Resistance

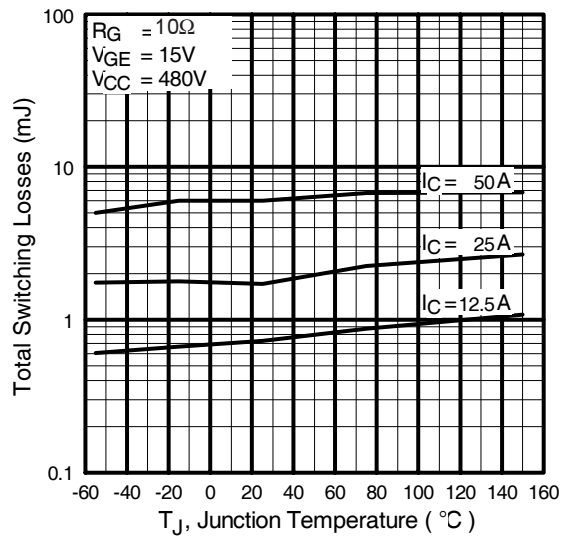

Fig. 10 - Typical Switching Losses vs. Junction Temperature

IRG4PC40KDPbF

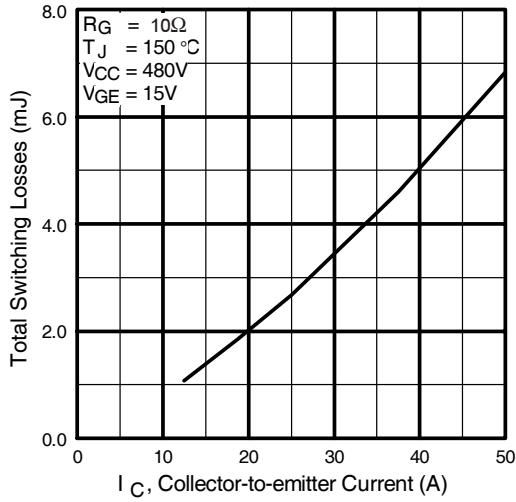

Fig. 11 - Typical Switching Losses vs. Collector-to-Emitter Current

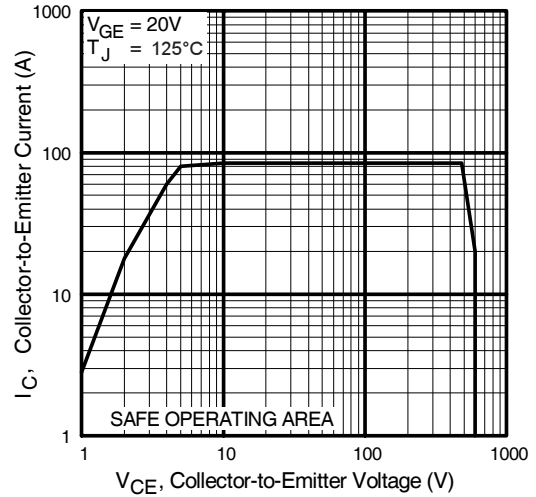

Fig. 12 - Turn-Off SOA

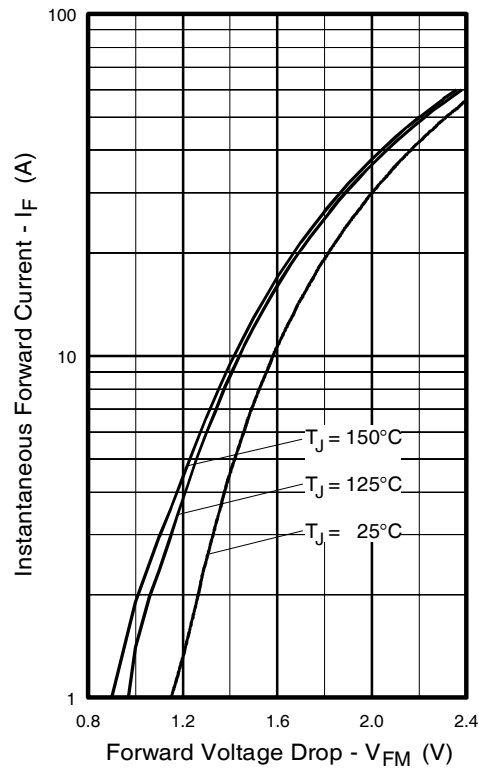

Fig. 13 - Maximum Forward Voltage Drop vs. Instantaneous Forward Current

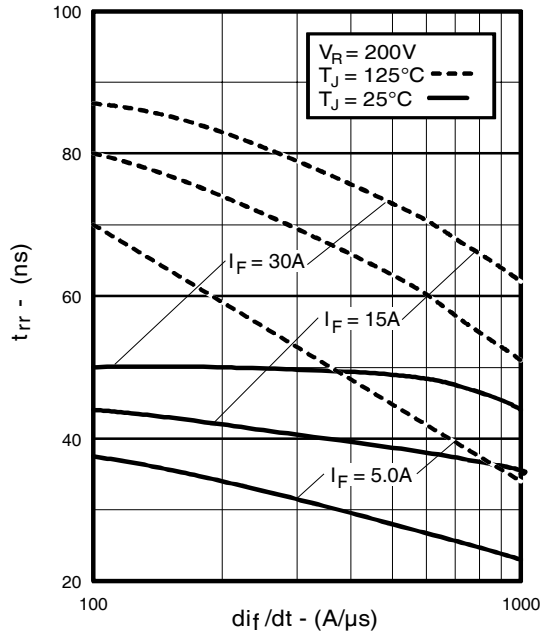

Fig. 14 - Typical Reverse Recovery vs. dI_F/dt

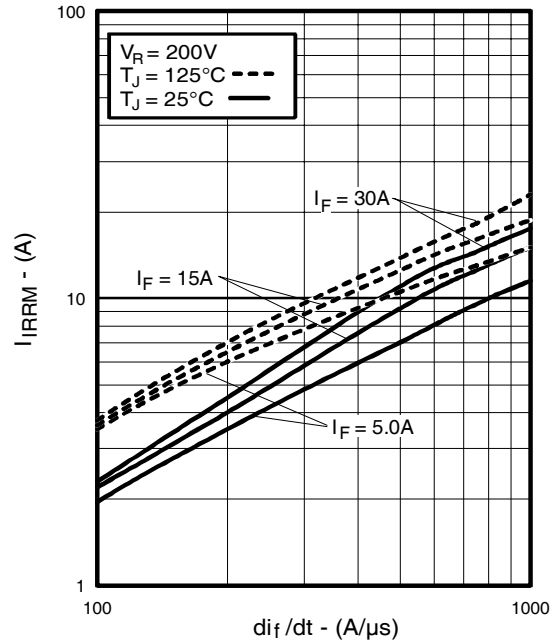

Fig. 15 - Typical Recovery Current vs. dI_F/dt

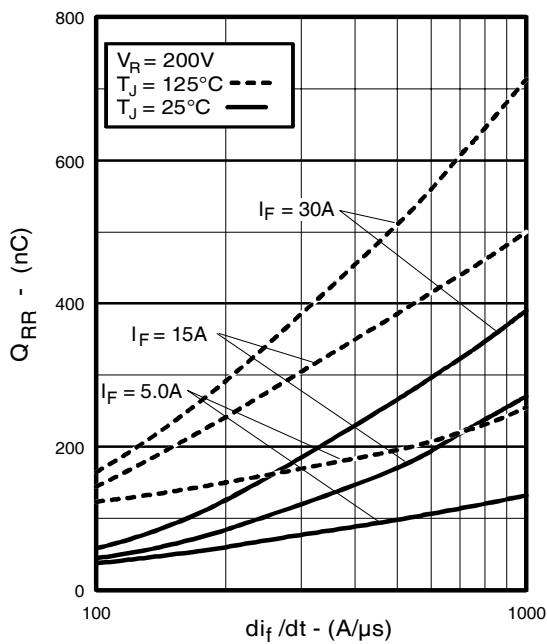

Fig. 16 - Typical Stored Charge vs. dI_F/dt

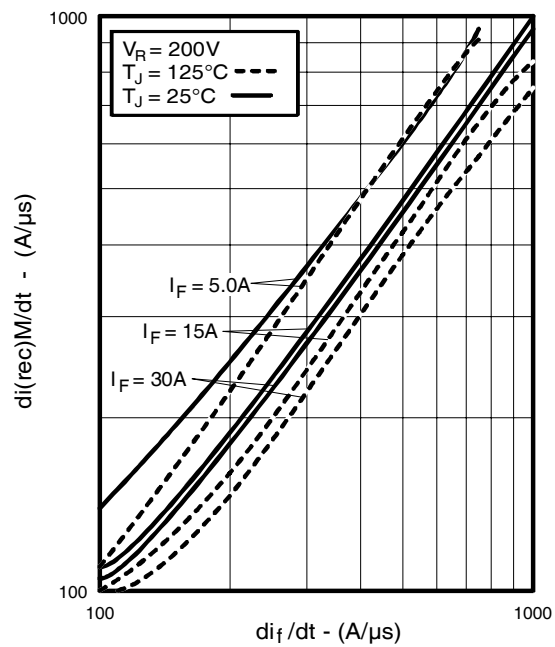

Fig. 17 - Typical $dI_{(rec)M}/dt$ vs. dI_F/dt

IRG4PC40KDPbF

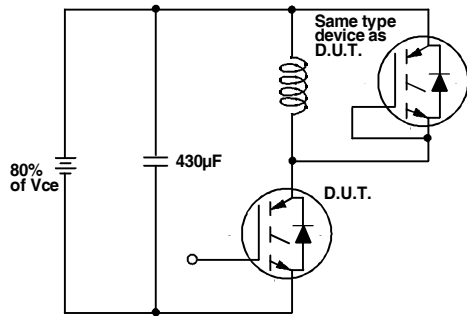

Fig. 18a - Test Circuit for Measurement of I_{LM} , E_{on} , $E_{off}(\text{diode})$, t_{rr} , Q_{rr} , I_{rr} , $t_{d(on)}$, t_r , $t_{d(off)}$, t_f

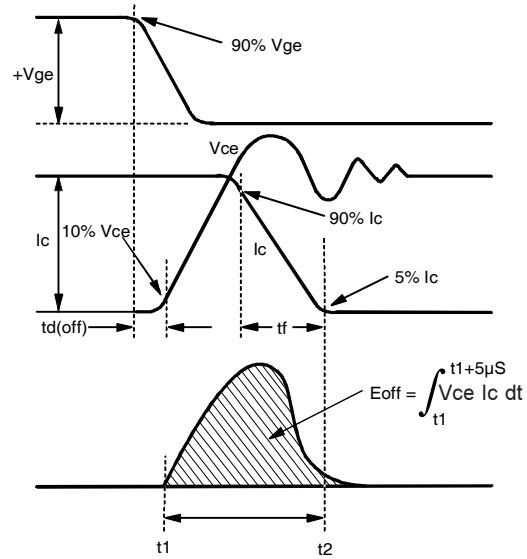

Fig. 18b - Test Waveforms for Circuit of Fig. 18a, Defining E_{off} , $t_{d(off)}$, t_f

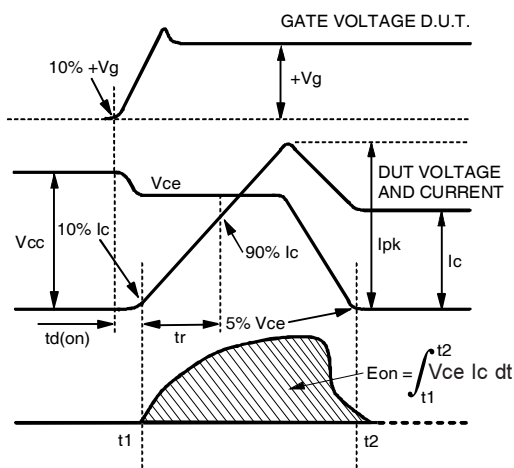

Fig. 18c - Test Waveforms for Circuit of Fig. 18a, Defining E_{on} , $t_{d(on)}$, t_r

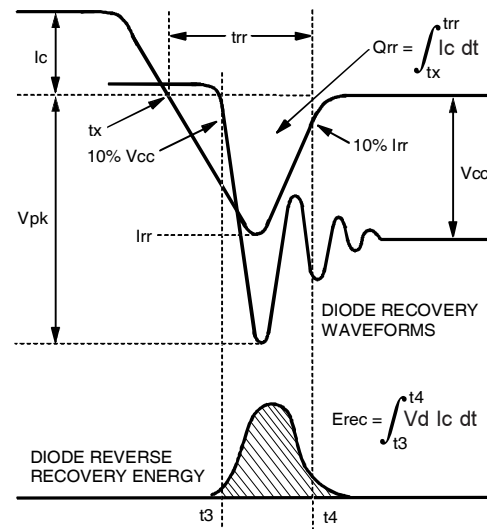

Fig. 18d - Test Waveforms for Circuit of Fig. 18a, Defining E_{rec} , t_{rr} , Q_{rr} , I_{rr}

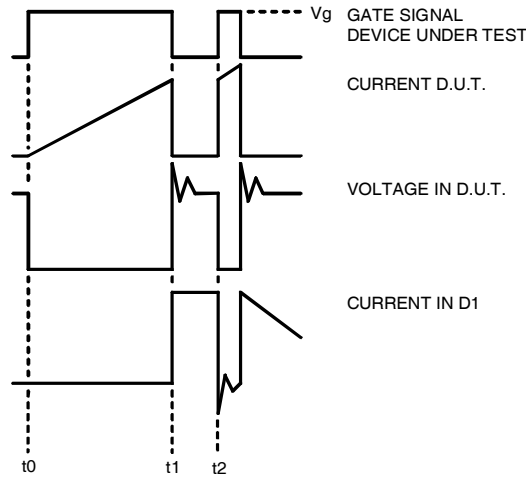

Figure 18e. Macro Waveforms for Figure 18a's Test Circuit



Figure 19. Clamped Inductive Load Test Circuit

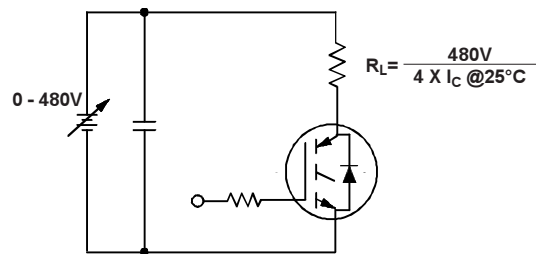

Figure 20. Pulsed Collector Current Test Circuit

IRG4PC40KDPbF

Notes:

- ① Repetitive rating: $V_{GE}=20V$; pulse width limited by maximum junction temperature (figure 20)
- ② $V_{CC}=80\%(V_{CES})$, $V_{GE}=20V$, $L=10\mu H$, $R_G=10\Omega$ (figure 19)
- ③ Pulse width $\leq 80\mu s$; duty factor $\leq 0.1\%$.
- ④ Pulse width $5.0\mu s$, single shot.

TO-247AC Package Outline

Dimensions are shown in millimeters (inches)

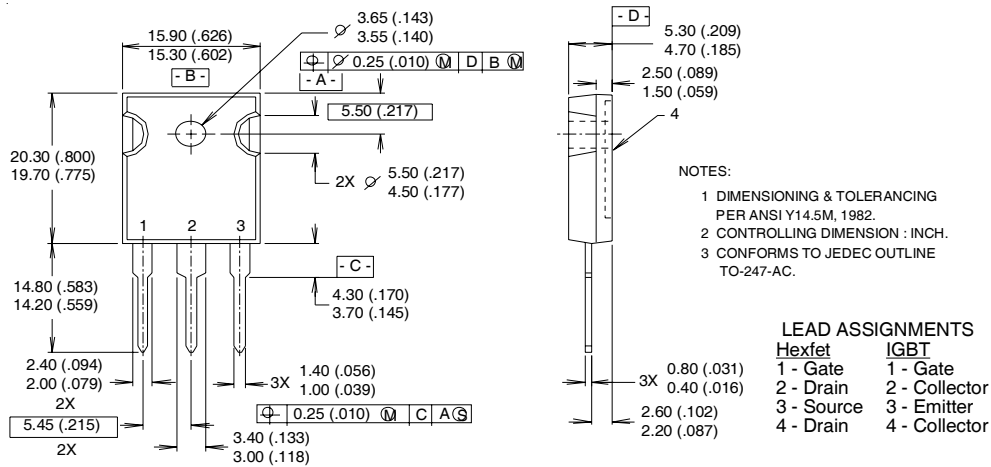

TO-247AC Part Marking Information

EXAMPLE: THIS IS AN IRFPE30
WITH ASSEMBLY
LOT CODE 5657
ASSEMBLED ON WW35, 2000
IN THE ASSEMBLY LINE "H"
Note: "P" in assembly line
position indicates "Lead-Free"

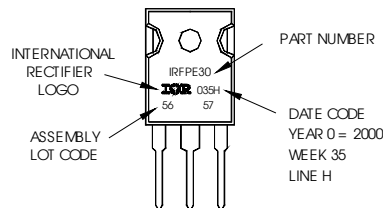

Data and specifications subject to change without notice.

Note: For the most current drawings please refer to the IR website at:
<http://www.irf.com/package/>