

IRG4PH30KDPbF

INSULATED GATE BIPOLAR TRANSISTOR WITH ULTRAFAST SOFT RECOVERY DIODE

Short Circuit Rated UltraFast IGBT

Features

- High short circuit rating optimized for motor control, $t_{sc} = 10\mu s$, $V_{CC} = 720V$, $T_J = 125^\circ C$, $V_{GE} = 15V$
- Combines low conduction losses with high switching speed
- Tighter parameter distribution and higher efficiency than previous generations
- IGBT co-packaged with HEXFRED™ ultrafast, ultrasoft recovery antiparallel diodes

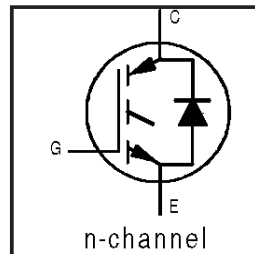

| |
|-----------------------------------|
| $V_{CES} = 1200V$ |
| $V_{CE(on)} \text{ typ.} = 3.10V$ |
| @ $V_{GE} = 15V, I_C = 10A$ |

Benefits

- Latest generation 4 IGBT's offer highest power density motor controls possible
- HEXFRED™ diodes optimized for performance with IGBTs. Minimized recovery characteristics reduce noise, EMI and switching losses
- This part replaces IRGPH30MD2 products
- For hints see design tip 97003
- Lead-Free

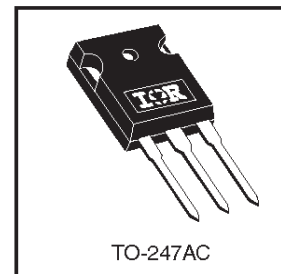

Absolute Maximum Ratings

| | Parameter | Max. | Units |
|---------------------------|--|---------------------|------------|
| V_{CES} | Collector-to-Emitter Voltage | 1200 | V |
| $I_C @ T_C = 25^\circ C$ | Continuous Collector Current | 20 | A |
| $I_C @ T_C = 100^\circ C$ | Continuous Collector Current | 10 | |
| I_{CM} | Pulsed Collector Current ① | 40 | |
| I_{LM} | Clamped Inductive Load Current ② | 40 | |
| $I_F @ T_C = 100^\circ C$ | Diode Continuous Forward Current | 10 | |
| I_{FM} | Diode Maximum Forward Current | 40 | |
| t_{sc} | Short Circuit Withstand Time | 10 | μs |
| V_{GE} | Gate-to-Emitter Voltage | ± 20 | V |
| $P_D @ T_C = 25^\circ C$ | Maximum Power Dissipation | 100 | W |
| $P_D @ T_C = 100^\circ C$ | Maximum Power Dissipation | 42 | |
| T_J | Operating Junction and Storage Temperature Range | -55 to +150 | $^\circ C$ |
| T_{STG} | | | |
| | | | |
| | Mounting Torque, 6-32 or M3 Screw. | 10 lbf•in (1.1 N•m) | |

Thermal Resistance

| | Parameter | Min. | Typ. | Max. | Units |
|-----------------|---|------|----------|------|--------------|
| $R_{\theta JC}$ | Junction-to-Case - IGBT | --- | --- | 1.2 | $^\circ C/W$ |
| $R_{\theta JC}$ | Junction-to-Case - Diode | --- | --- | 2.5 | |
| $R_{\theta CS}$ | Case-to-Sink, flat, greased surface | --- | 0.24 | --- | |
| $R_{\theta JA}$ | Junction-to-Ambient, typical socket mount | --- | --- | 40 | |
| Wt | Weight | --- | 6 (0.21) | --- | g (oz) |

Electrical Characteristics @ T_J = 25°C (unless otherwise specified)

| | Parameter | Min. | Typ. | Max. | Units | Conditions |
|--|---|------|------|------|-------|---|
| V _{(BR)CES} | Collector-to-Emitter Breakdown Voltage ^③ | 1200 | — | — | V | V _{GE} = 0V, I _C = 250μA |
| ΔV _{(BR)CES} /ΔT _J | Temperature Coeff. of Breakdown Voltage | — | 0.19 | — | V/°C | V _{GE} = 0V, I _C = 1.0mA |
| V _{CE(on)} | Collector-to-Emitter Saturation Voltage | — | 3.10 | 4.2 | V | I _C = 10A V _{GE} = 15V |
| | | — | 3.90 | — | | I _C = 20A See Fig. 2, 5 |
| | | — | 3.01 | — | | I _C = 10A, T _J = 150°C |
| V _{GE(th)} | Gate Threshold Voltage | 3.0 | — | 6.0 | | V _{CE} = V _{GE} , I _C = 250μA |
| ΔV _{GE(th)} /ΔT _J | Temperature Coeff. of Threshold Voltage | — | -12 | — | mV/°C | V _{CE} = V _{GE} , I _C = 250μA |
| g _{fe} | Forward Transconductance ^④ | 4.3 | 6.5 | — | S | V _{CE} = 100V, I _C = 10A |
| I _{CES} | Zero Gate Voltage Collector Current | — | — | 250 | μA | V _{GE} = 0V, V _{CE} = 1200V |
| | | — | — | 3500 | | V _{GE} = 0V, V _{CE} = 1200V, T _J = 150°C |
| V _{FM} | Diode Forward Voltage Drop | — | 3.4 | 3.8 | V | I _C = 10A See Fig. 13 |
| | | — | 3.3 | 3.7 | | I _C = 10A, T _J = 150°C |
| I _{GES} | Gate-to-Emitter Leakage Current | — | — | ±100 | nA | V _{GE} = ±20V |

Switching Characteristics @ T_J = 25°C (unless otherwise specified)

| | Parameter | Min. | Typ. | Max. | Units | Conditions |
|--------------------------|---|------|------|------|-------|--|
| Q _g | Total Gate Charge (turn-on) | — | 53 | 80 | nC | I _C = 10A |
| Q _{ge} | Gate - Emitter Charge (turn-on) | — | 9.0 | 14 | | V _{CC} = 400V See Fig. 8 |
| Q _{gc} | Gate - Collector Charge (turn-on) | — | 21 | 32 | | V _{GE} = 15V |
| t _{d(on)} | Turn-On Delay Time | — | 39 | — | ns | T _J = 25°C I _C = 10A, V _{CC} = 800V V _{GE} = 15V, R _G = 23Ω |
| t _r | Rise Time | — | 84 | — | | |
| t _{d(off)} | Turn-Off Delay Time | — | 220 | 340 | | |
| t _f | Fall Time | — | 90 | 140 | | |
| E _{on} | Turn-On Switching Loss | — | 0.95 | — | mJ | Energy losses include "tail" and diode reverse recovery See Fig. 9, 10, 18 |
| E _{off} | Turn-Off Switching Loss | — | 1.15 | — | | |
| E _{ts} | Total Switching Loss | — | 2.10 | 2.6 | | |
| t _{sc} | Short Circuit Withstand Time | 10 | — | — | μs | V _{CC} = 720V, T _J = 125°C V _{GE} = 15V, R _G = 5.0Ω |
| t _{d(on)} | Turn-On Delay Time | — | 42 | — | ns | T _J = 150°C, See Fig. 10, 11, 18 I _C = 10A, V _{CC} = 800V V _{GE} = 15V, R _G = 23Ω, Energy losses include "tail" and diode reverse recovery |
| t _r | Rise Time | — | 79 | — | | |
| t _{d(off)} | Turn-Off Delay Time | — | 540 | — | | |
| t _f | Fall Time | — | 97 | — | | |
| E _{ts} | Total Switching Loss | — | 3.5 | — | mJ | |
| L _E | Internal Emitter Inductance | — | 13 | — | nH | Measured 5mm from package |
| C _{ies} | Input Capacitance | — | 800 | — | pF | V _{GE} = 0V V _{CC} = 30V See Fig. 7 f = 1.0MHz |
| C _{oes} | Output Capacitance | — | 60 | — | | |
| C _{res} | Reverse Transfer Capacitance | — | 14 | — | | |
| t _{rr} | Diode Reverse Recovery Time | — | 50 | 76 | ns | T _J = 25°C See Fig. 14 |
| | | — | 72 | 110 | | T _J = 125°C |
| I _{rr} | Diode Peak Reverse Recovery Current | — | 4.4 | 7.0 | A | T _J = 25°C See Fig. 15 |
| | | — | 5.9 | 8.8 | | T _J = 125°C |
| Q _{rr} | Diode Reverse Recovery Charge | — | 130 | 200 | nC | T _J = 25°C See Fig. 16 |
| | | — | 250 | 380 | | T _J = 125°C |
| di _{(rec)M} /dt | Diode Peak Rate of Fall of Recovery During t _b | — | 210 | — | A/μs | T _J = 25°C See Fig. 17 |
| | | — | 180 | — | | T _J = 125°C |

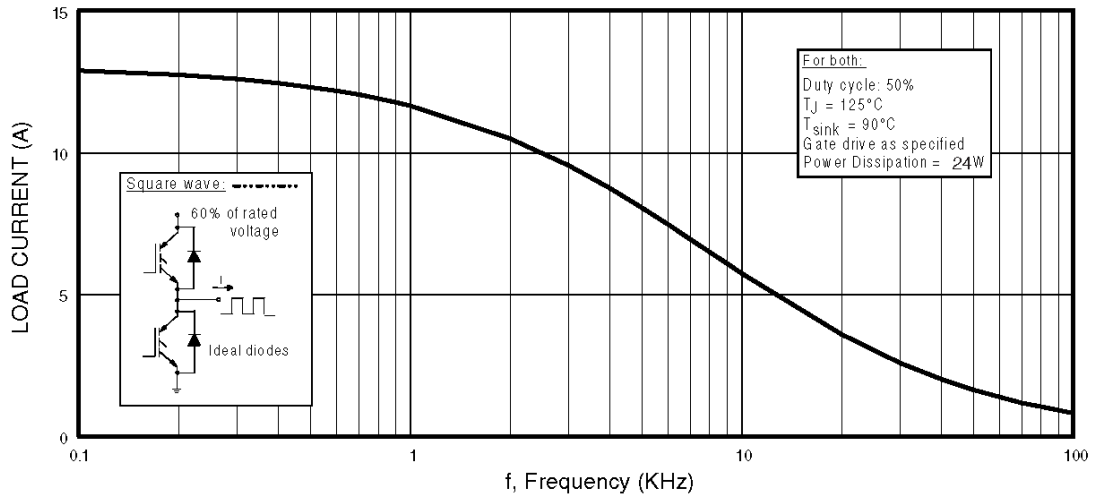

Fig. 1 - Typical Load Current vs. Frequency
 (Load Current = I_{RMS} of fundamental)

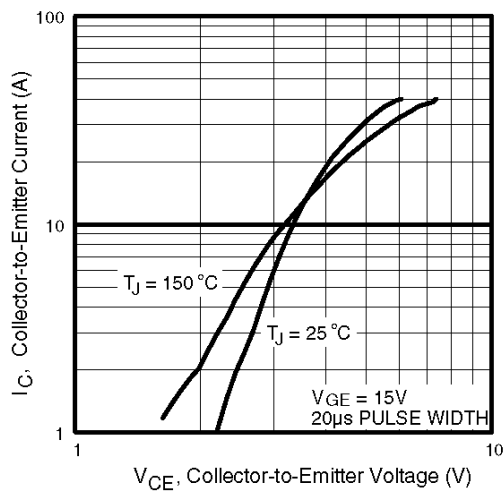

Fig. 2 - Typical Output Characteristics

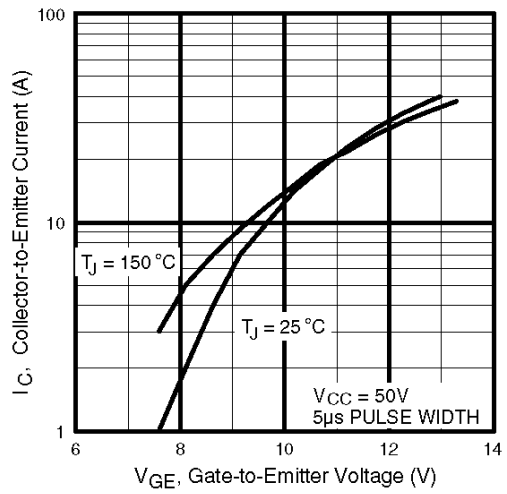

Fig. 3 - Typical Transfer Characteristics

IRG4PH30KDPbF

International
IR Rectifier

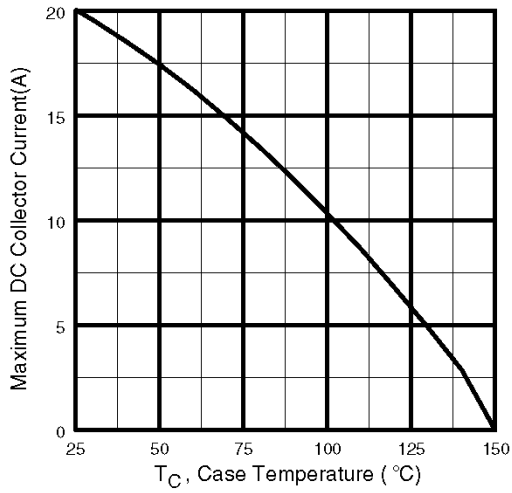

Fig. 4 - Maximum Collector Current vs. Case Temperature

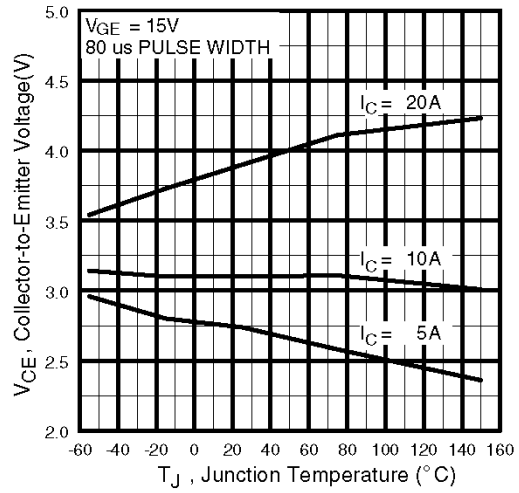

Fig. 5 - Typical Collector-to-Emitter Voltage vs. Junction Temperature

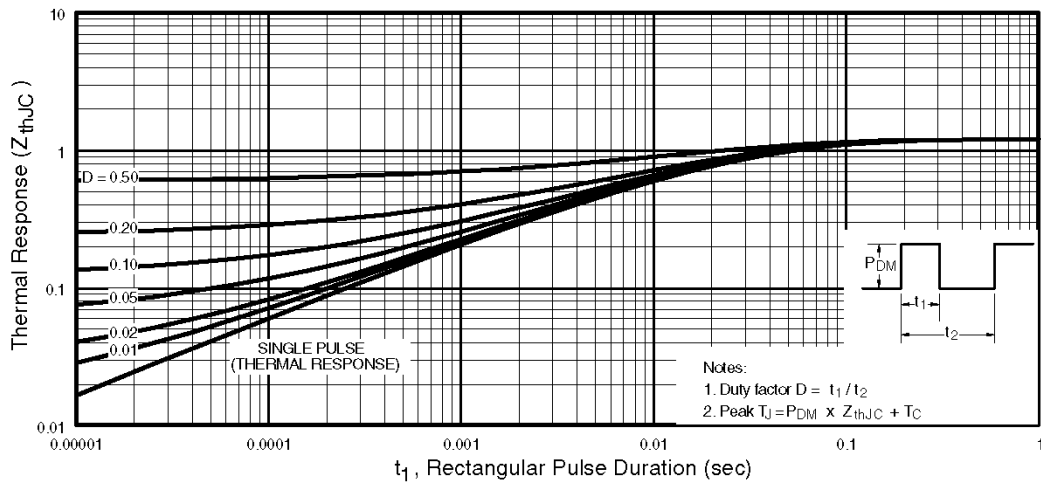

Fig. 6 - Maximum Effective Transient Thermal Impedance, Junction-to-Case

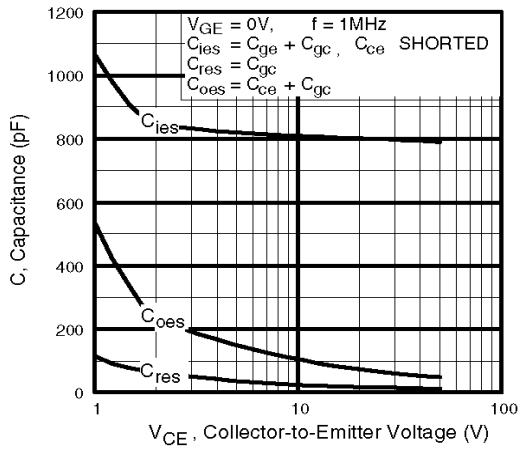

Fig. 7 - Typical Capacitance vs. Collector-to-Emitter Voltage

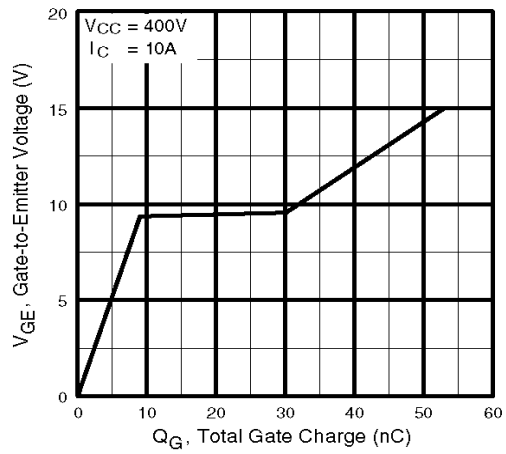

Fig. 8 - Typical Gate Charge vs. Gate-to-Emitter Voltage

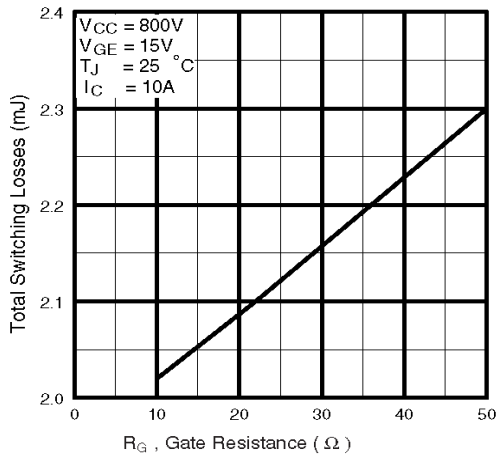

Fig. 9 - Typical Switching Losses vs. Gate Resistance

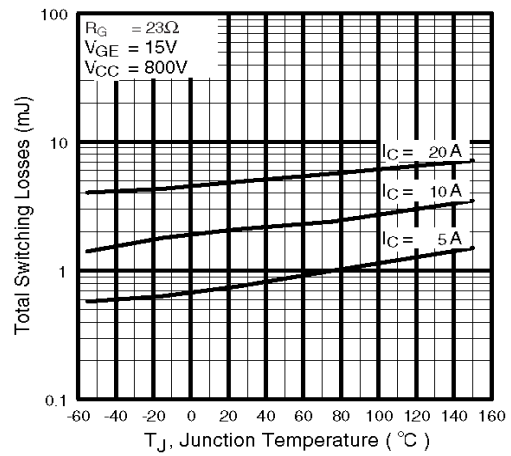

Fig. 10 - Typical Switching Losses vs. Junction Temperature

IRG4PH30KDPbF

International
IR Rectifier

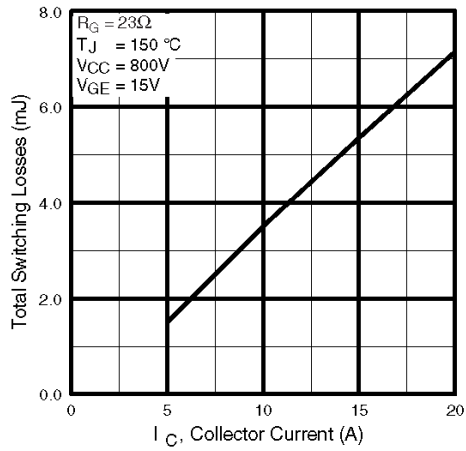

Fig. 11 - Typical Switching Losses vs. Collector Current

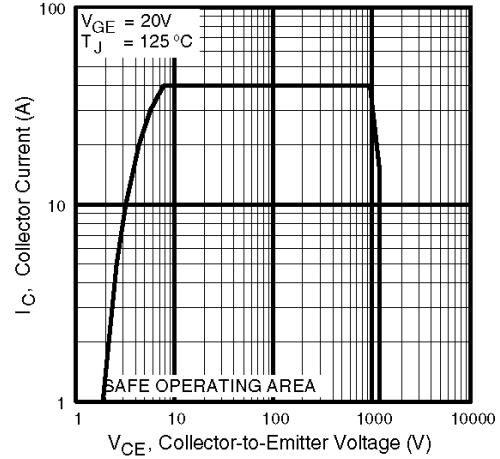

Fig. 12 - Turn-Off SOA

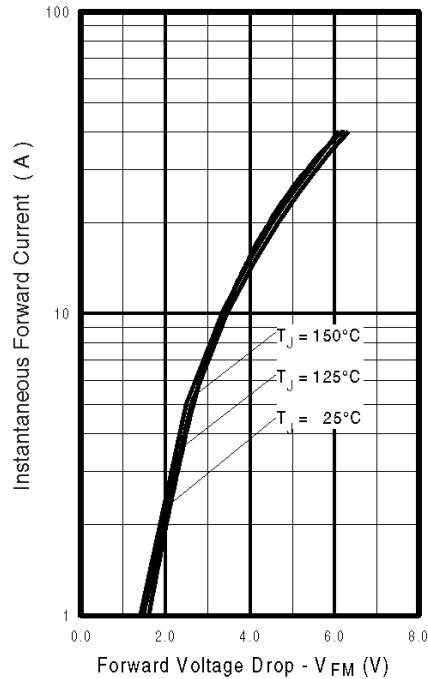

Fig. 13 - Typical Forward Voltage Drop vs. Instantaneous Forward Current

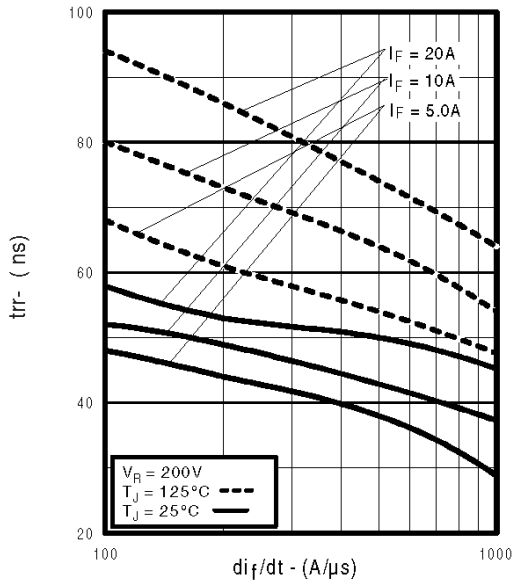

Fig. 14 - Typical Reverse Recovery vs. di_f/dt

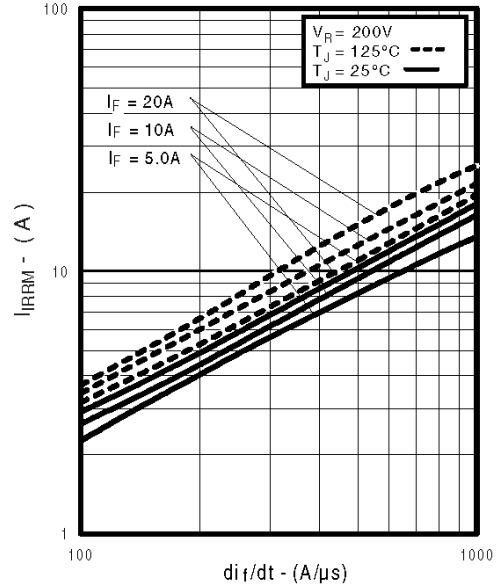

Fig. 15 - Typical Recovery Current vs. di_f/dt

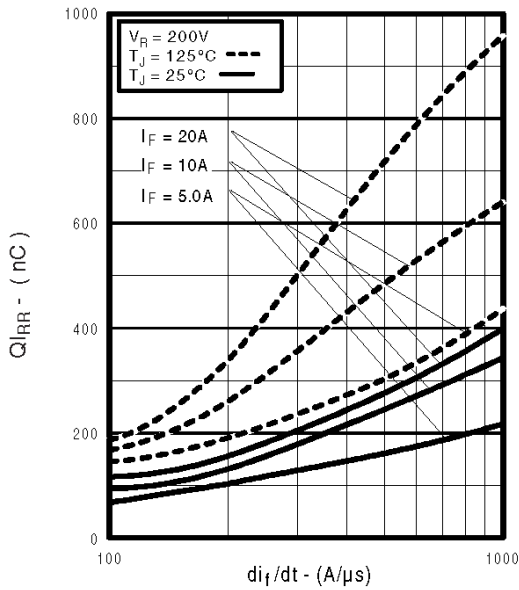

Fig. 16 - Typical Stored Charge vs. di_f/dt

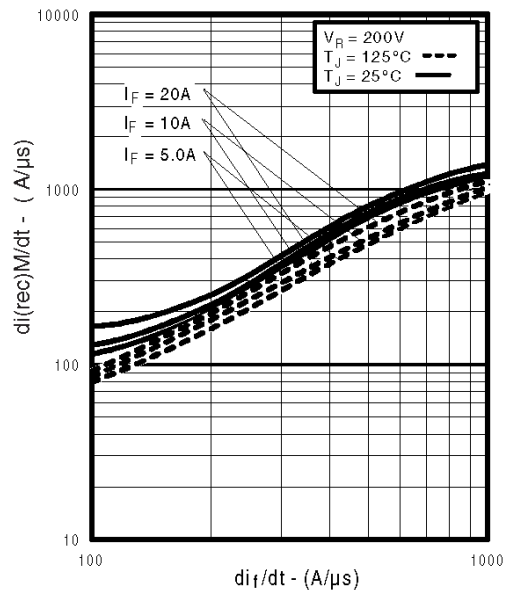

Fig. 17 - Typical $di_{(rec)M}/dt$ vs. di_f/dt

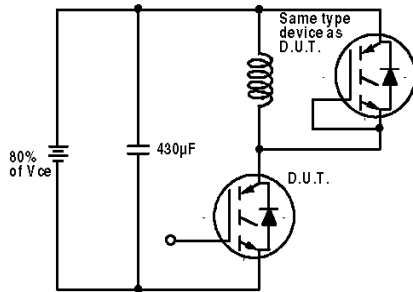

Fig. 18a - Test Circuit for Measurement of I_{LM} , E_{on} , $E_{off}(\text{diode})$, t_{rr} , Q_{rr} , I_{rr} , $t_{d(on)}$, t_r , $t_{d(off)}$, t_f

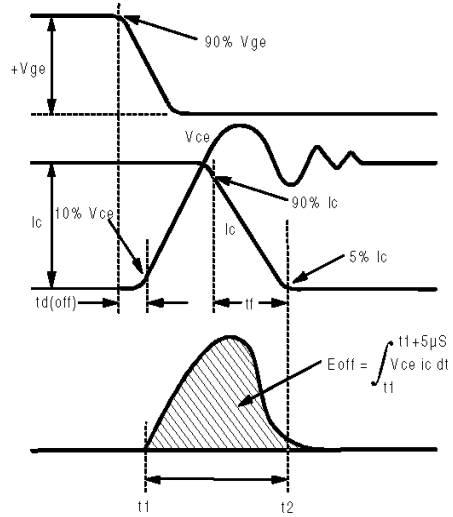

Fig. 18b - Test Waveforms for Circuit of Fig. 18a, Defining E_{off} , $t_{d(off)}$, t_f

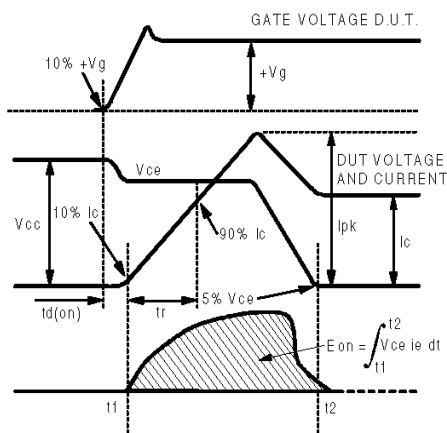

Fig. 18c - Test Waveforms for Circuit of Fig. 18a, Defining E_{on} , $t_{d(on)}$, t_r

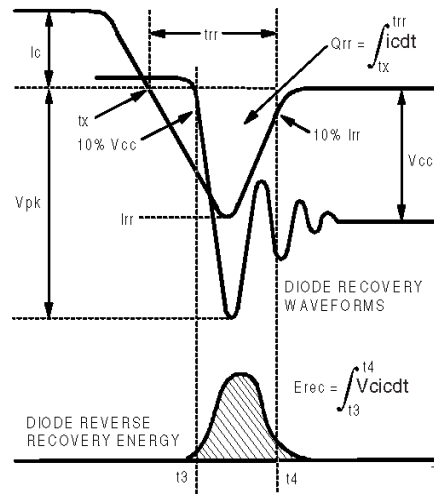

Fig. 18d - Test Waveforms for Circuit of Fig. 18a, Defining E_{rec} , t_{rr} , Q_{rr} , I_{rr}

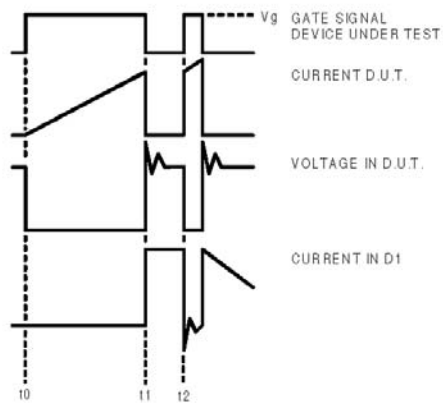

Figure 18e. Macro Waveforms for Figure 18a's Test Circuit

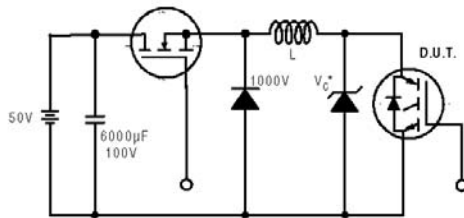

Figure 19. Clamped Inductive Load Test Circuit

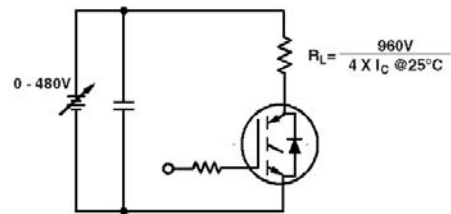

Figure 20. Pulsed Collector Current Test Circuit

IRG4PH30KDPbF

International
Rectifier

Notes:

- ① Repetitive rating: $V_{GE}=20V$; pulse width limited by maximum junction temperature (figure 20)
- ② $V_{CC}=80\%(V_{CES})$, $V_{GE}=20V$, $L=10\mu H$, $R_G=23\Omega$ (figure 19)
- ③ Pulse width $\leq 80\mu s$; duty factor $\leq 0.1\%$.
- ④ Pulse width $5.0\mu s$, single shot.

TO-247AC Package Outline

Dimensions are shown in millimeters (inches)

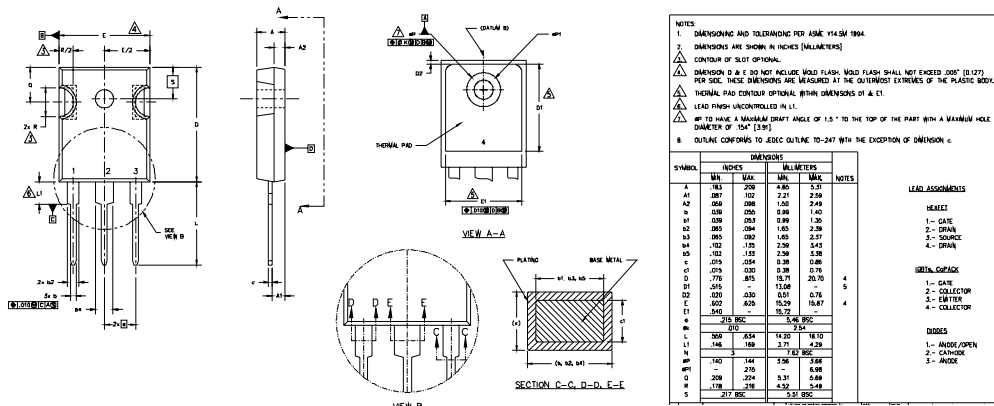

TO-247AC Part Marking Information

EXAMPLE: THIS IS AN IRFPE30
WITH ASSEMBLY
LOT CODE 5667
ASSEMBLED ON WW 35, 2000
IN THE ASSEMBLY LINE "H"
Note: "P" in assembly line
position indicates "Lead-Free"

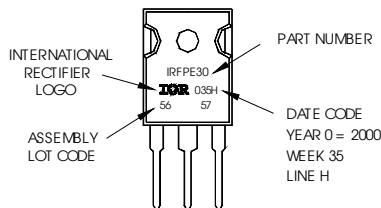

Data and specifications subject to change without notice.

International
Rectifier

IR WORLD HEADQUARTERS: 233 Kansas St., El Segundo, California 90245, USA Tel: (310) 252-7105
TAC Fax: (310) 252-7903

Visit us at www.irf.com for sales contact information.06/04

www.irf.com

Note: For the most current drawings please refer to the IR website at:
<http://www.irf.com/package/>