

## 20 A, 600 V fast IGBT with Ultrafast diode

### Features

- Very low on-voltage drop ( $V_{CE(sat)}$ )
- Minimum power losses at 5 kHz in hard switching
- Optimized performance for medium operating frequencies.
- IGBT co-packaged with Ultrafast freewheeling diode

### Application

Medium frequency motor drives

### Description

This IGBT utilizes the advanced PowerMESH™ process resulting in an excellent trade-off between switching performance and low on-state behavior.

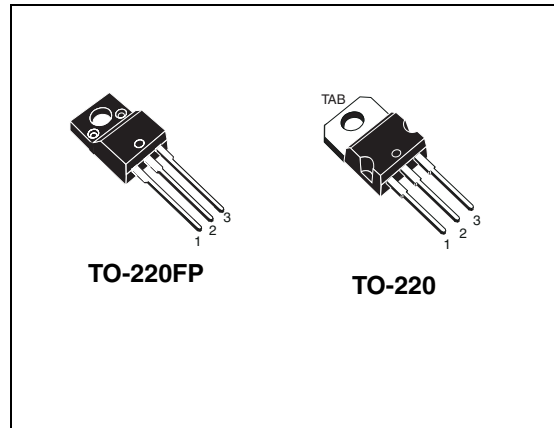

**Figure 1. Internal schematic diagram**

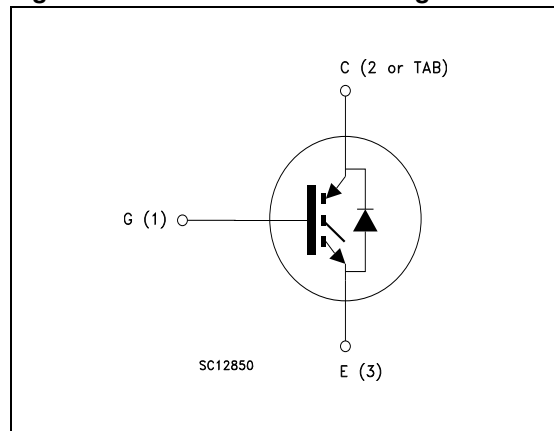

**Table 1. Device summary**

Order codes	Marking	Package	Packaging
STGF19NC60SD	GF19NC60SD	TO-220FP	Tube
STGP19NC60SD	GP19NC60SD	TO-220	Tube

# Contents

<b>1</b>	<b>Electrical ratings</b> .....	<b>3</b>
<b>2</b>	<b>Electrical characteristics</b> .....	<b>4</b>
	2.1 Electrical characteristics (curves) .....	6
	2.2 Frequency applications .....	9
<b>3</b>	<b>Test circuits</b> .....	<b>10</b>
<b>4</b>	<b>Package mechanical data</b> .....	<b>11</b>
<b>5</b>	<b>Revision history</b> .....	<b>14</b>

# 1 Electrical ratings

**Table 2. Absolute maximum ratings**

Symbol	Parameter	Value		Unit
		TO-220	TO-220FP	
V <sub>CES</sub>	Collector-emitter voltage (V <sub>GE</sub> = 0)	600		V
I <sub>C</sub> <sup>(1)</sup>	Continuous collector current at T <sub>C</sub> = 25°C	40	17	A
I <sub>C</sub> <sup>(1)</sup>	Continuous collector current at T <sub>C</sub> = 100°C	20	11	A
I <sub>CP</sub> <sup>(2)</sup>	Pulsed collector current	80		A
I <sub>CL</sub> <sup>(3)</sup>	Turn-off latching current	80		A
I <sub>F</sub>	Diode RMS forward current at T <sub>C</sub> = 25°C	20		A
I <sub>FSM</sub>	Surge non repetitive forward current t <sub>p</sub> = 10ms sinusoidal	50		A
V <sub>GE</sub>	Gate-emitter voltage	±20		V
V <sub>ISO</sub>	Insulation withstand voltage (RMS) from all three leads to external heat sink (t = 1 s; T <sub>C</sub> = 25 °C)	2500		V
P <sub>TOT</sub>	Total dissipation at T <sub>C</sub> = 25°C	130	32	W
T <sub>j</sub>	Operating junction temperature	- 55 to 150		°C

1. Calculated according to the iterative formula

$$I_C(T_C) = \frac{T_{j(max)} - T_C}{R_{thj-c} \times V_{CE(sat)(max)}(T_{j(max)}, I_C(T_C))}$$

2. Pulse width limited by maximum junction temperature and turn-off within RBSOA

3. V<sub>clamp</sub> = 80% of V<sub>CES</sub>, T<sub>j</sub> = 150 °C, R<sub>G</sub> = 10 Ω, V<sub>GE</sub> = 15 V

**Table 3. Thermal data**

Symbol	Parameter	Value		Unit
		TO-220	TO-220FP	
R <sub>thj-c</sub>	Thermal resistance junction-case IGBT	0.96	3.9	°C/W
	Thermal resistance junction-case diode	3	5.5	°C/W
R <sub>thj-a</sub>	Thermal resistance junction-ambient	62.5		°C/W

## 2 Electrical characteristics

( $T_j = 25^\circ\text{C}$  unless otherwise specified)

**Table 4. Static**

Symbol	Parameter	Test conditions	Min.	Typ.	Max.	Unit
$V_{(BR)CES}$	Collector-emitter breakdown voltage ( $V_{GE} = 0$ )	$I_C = 1\text{mA}$	600			V
$V_{CE(sat)}$	Collector-emitter saturation voltage	$V_{GE} = 15\text{V}, I_C = 12\text{A}$ $V_{GE} = 15\text{V}, I_C = 12\text{A}, T_j = 125^\circ\text{C}$		1.55 1.35	1.9	V V
$V_{GE(th)}$	Gate threshold voltage	$V_{CE} = V_{GE}, I_C = 250\ \mu\text{A}$	4.2		6.2	V
$I_{CES}$	Collector cut-off current ( $V_{GE} = 0$ )	$V_{CE} = 600\text{V}$ $V_{CE} = 600\text{V}, T_j = 125^\circ\text{C}$			150 1	$\mu\text{A}$ mA
$I_{GES}$	Gate-emitter leakage current ( $V_{CE} = 0$ )	$V_{GE} = \pm 20\text{V}, V_{CE} = 0$			$\pm 100$	nA
$g_{fs}$	Forward transconductance	$V_{CE} = 15\text{V}, I_C = 12\text{A}$		10		S

**Table 5. Dynamic**

Symbol	Parameter	Test conditions	Min.	Typ.	Max.	Unit
$C_{ies}$	Input capacitance	$V_{CE} = 25\text{V}, f = 1\text{MHz},$ $V_{GE} = 0$	-	1190	-	pF
$C_{oes}$	Output capacitance			135		pF
$C_{res}$	Reverse transfer capacitance			28.5		pF
$Q_g$	Total gate charge	$V_{CE} = 480\text{V}, I_C = 12\text{A},$ $V_{GE} = 15\text{V},$ <i>Figure 20</i>	-	54.5	-	nC
$Q_{ge}$	Gate-emitter charge			8.7		nC
$Q_{gc}$	Gate-collector charge			25.8		nC

Table 6. Switching on/off (inductive load)

Symbol	Parameter	Test conditions	Min.	Typ.	Max.	Unit
$t_{d(on)}$ $t_r$ (di/dt) <sub>on</sub>	Turn-on delay time Current rise time Turn-on current slope	$V_{CC} = 480V, I_C = 12A$ $R_G = 10\Omega, V_{GE} = 15V,$ <i>Figure 21</i>	-	17.5 6.2 1870	-	ns ns A/ $\mu$ s
$t_{d(on)}$ $t_r$ (di/dt) <sub>on</sub>	Turn-on delay time Current rise time Turn-on current slope	$V_{CC} = 480V, I_C = 12A$ $R_G = 10\Omega, V_{GE} = 15V,$ $T_j = 125^\circ C$ <i>Figure 21</i>	-	17 6.5 1700	-	ns ns A/ $\mu$ s
$t_{r(Voff)}$ $t_{d(Voff)}$ $t_f$	Off voltage rise time Turn-off delay time Current fall time	$V_{CC} = 480V, I_C = 12A$ $R_G = 10\Omega, V_{GE} = 15V,$ <i>Figure 21</i>	-	90 175 215	-	ns ns ns
$t_{r(Voff)}$ $t_{d(Voff)}$ $t_f$	Off voltage rise time Turn-off delay time Current fall time	$V_{CC} = 480V, I_C = 12A$ $R_G = 10\Omega, V_{GE} = 15V,$ $T_j = 125^\circ C$ <i>Figure 21</i>	-	155 245 290	-	ns ns ns

Table 7. Switching energy (inductive load)

Symbol	Parameter	Test conditions	Min.	Typ.	Max.	Unit
$E_{on}$ $E_{off}^{(1)}$ $E_{ts}$	Turn-on switching losses Turn-off switching losses Total switching losses	$V_{CC} = 480 V, I_C = 12 A$ $R_G = 10 \Omega, V_{GE} = 15 V,$ <i>Figure 19</i>	-	135 815 995	-	$\mu$ J $\mu$ J $\mu$ J
$E_{on}$ $E_{off}^{(1)}$ $E_{ts}$	Turn-on switching losses Turn-off switching losses Total switching losses	$V_{CC} = 480 V, I_C = 12 A$ $R_G = 10 \Omega, V_{GE} = 15 V,$ $T_j = 125^\circ C$ <i>Figure 19</i>	-	200 1175 1375	-	$\mu$ J $\mu$ J $\mu$ J

1. Turn-off losses include also the tail of the collector current

Table 8. Collector-emitter diode

Symbol	Parameter	Test conditions	Min.	Typ.	Max.	Unit
$V_F$	Forward on-voltage	$I_F = 12 A$ $I_F = 12 A, T_j = 125^\circ C$		2.3 2.0		V V
$t_{rr}$ $Q_{rr}$ $I_{rrm}$	Reverse recovery time Reverse recovery charge Reverse recovery current	$I_F = 12 A, V_R = 40 V,$ $di/dt = 100 A/\mu s$ <i>Figure 22</i>		31 29.5 1.9		ns nC A
$t_{rr}$ $Q_{rr}$ $I_{rrm}$	Reverse recovery time Reverse recovery charge Reverse recovery current	$I_F = 12 A, V_R = 40 V,$ $di/dt = 100 A/\mu s, T_j = 125^\circ C$ <i>Figure 22</i>		48.5 70.5 3		ns nC A

## 2.1 Electrical characteristics (curves)

Figure 2. Output characteristics

Figure 3. Transfer characteristics

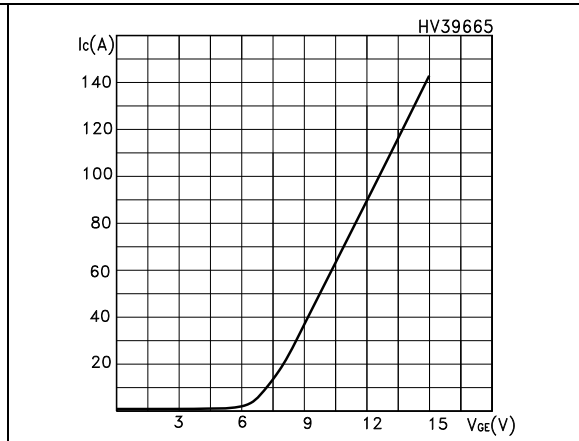
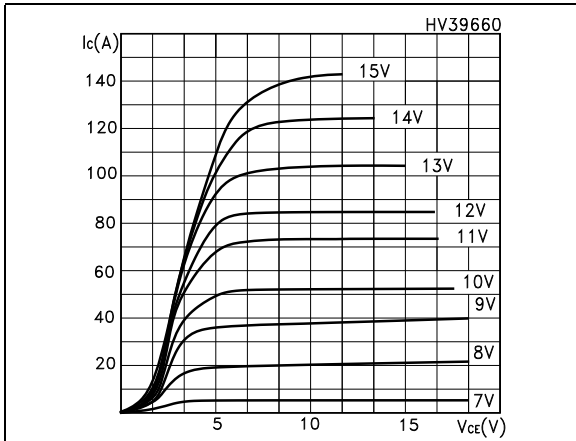

Figure 4. Transconductance

Figure 5. Collector-emitter on voltage vs temperature

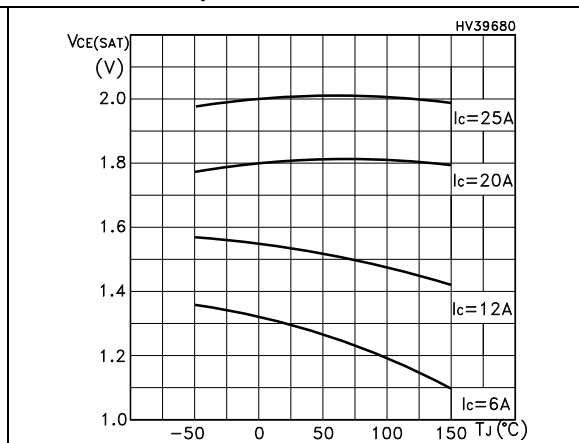
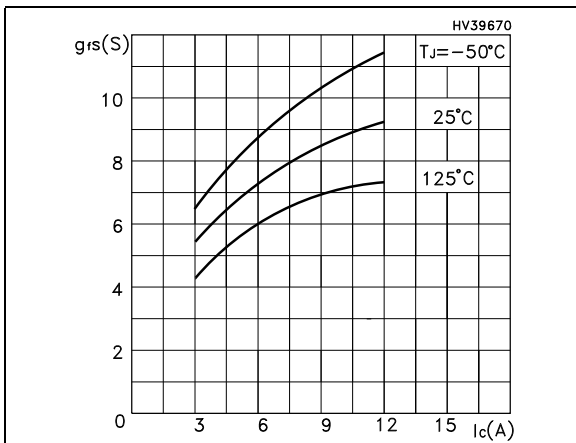

Figure 6. Gate charge vs gate-source voltage

Figure 7. Capacitance variations

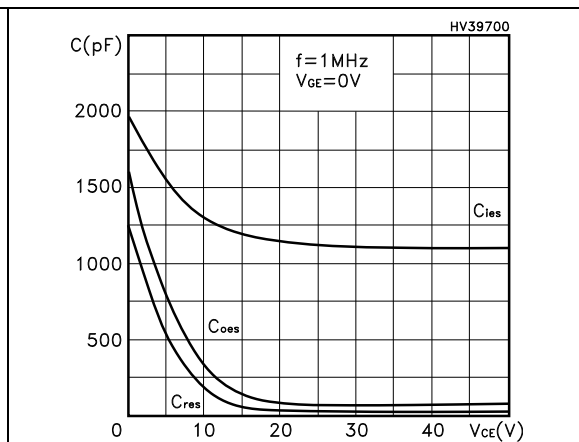
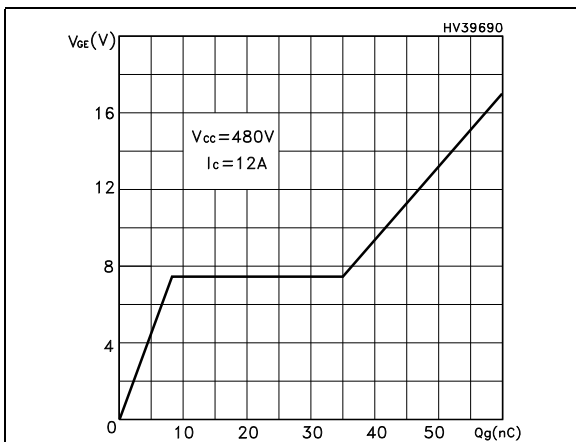

Figure 8. Normalized gate threshold voltage vs temperature

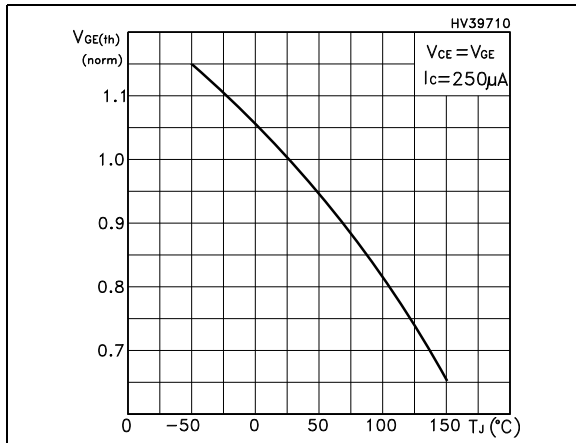

Figure 9. Collector-emitter on voltage vs collector current

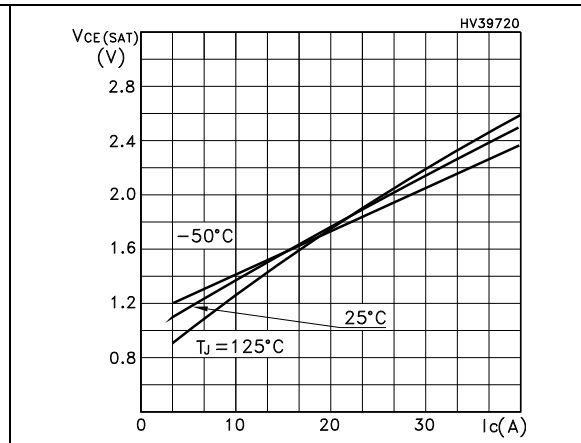

Figure 10. Normalized breakdown voltage vs temperature

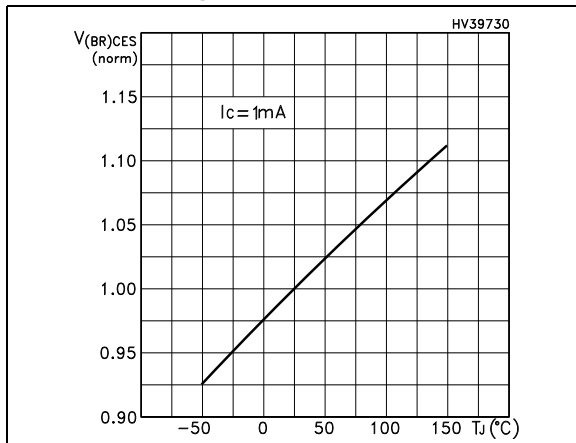

Figure 11. Switching losses vs temperature

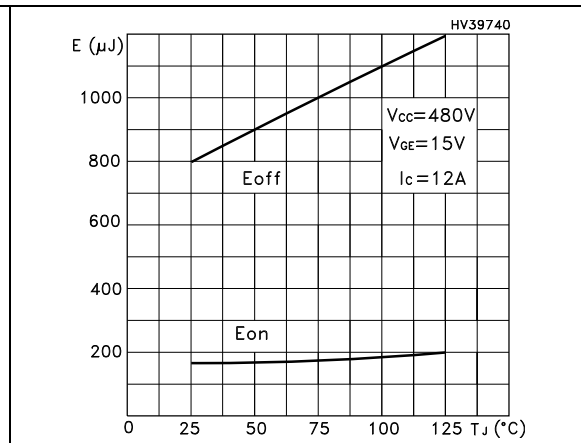

Figure 12. Switching losses vs gate resistance

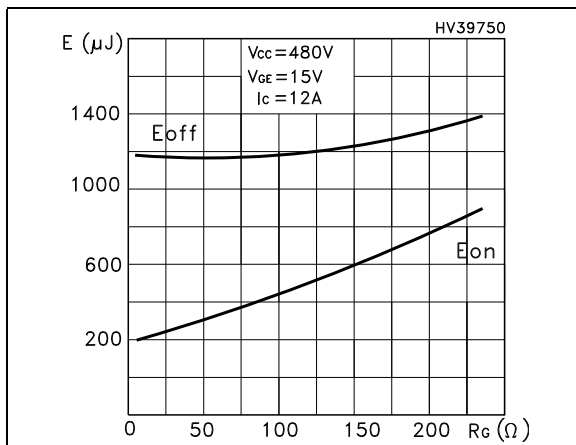

Figure 13. Switching losses vs collector current

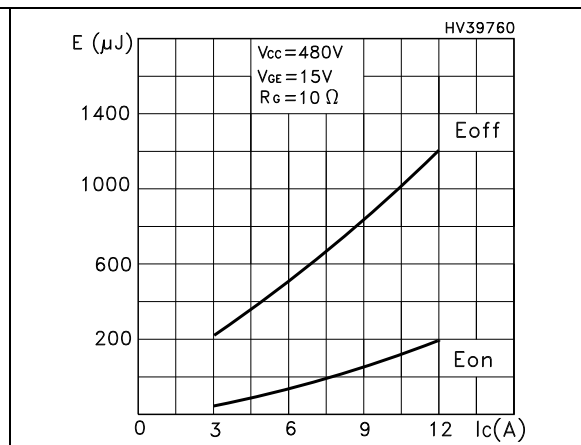

Figure 14. Turn-off SOA

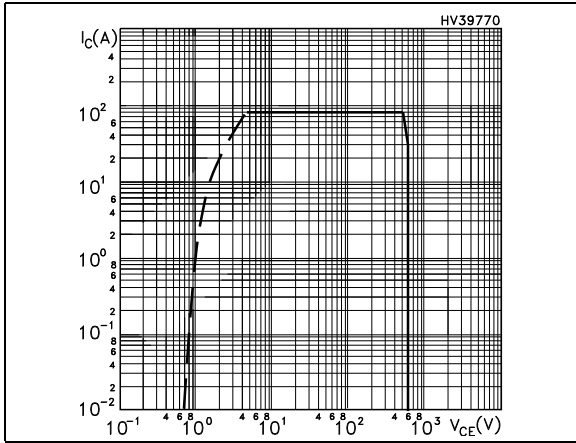

Figure 15. Thermal impedance for TO-220

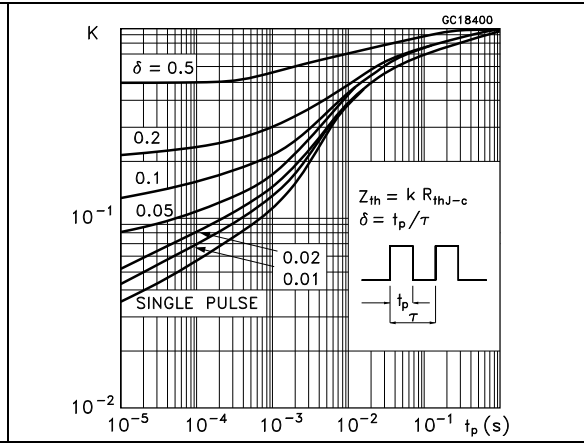

Figure 16. Thermal impedance for TO-220FP

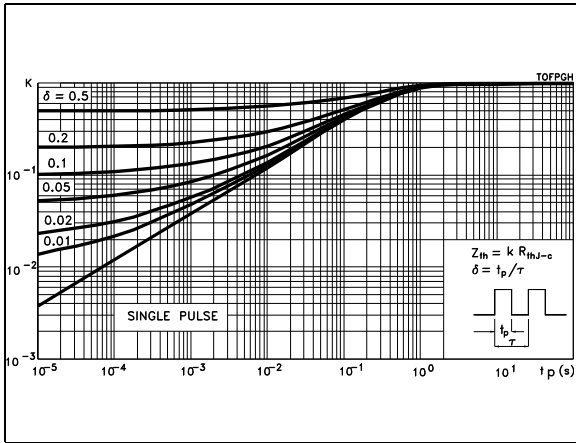

Figure 17. Forward voltage drop versus forward current

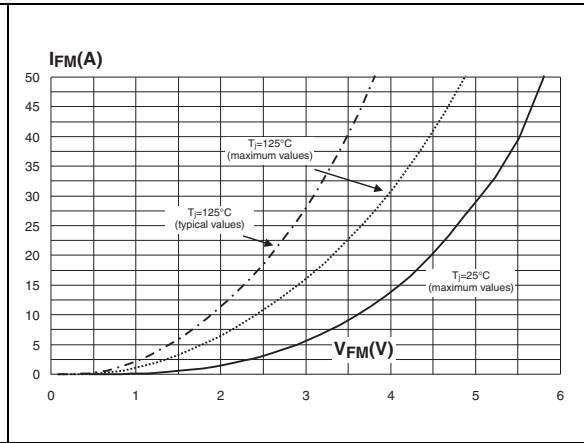
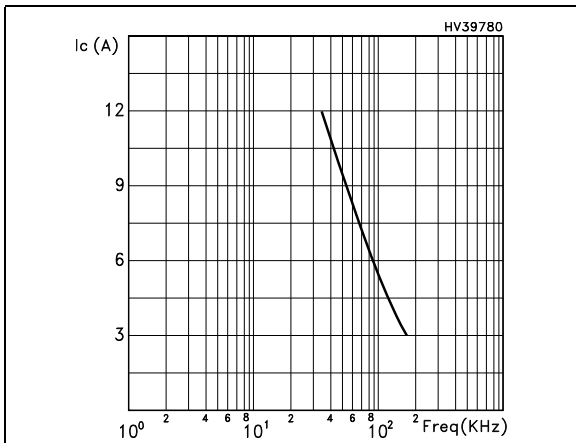

Figure 18. Ic vs. frequency





## 2.2 Frequency applications

For a fast IGBT suitable for high frequency applications, the typical collector current vs. maximum operating frequency curve is reported. That frequency is defined as follows:

$$f_{\text{MAX}} = (P_D - P_C) / (E_{\text{ON}} + E_{\text{OFF}})$$

- The maximum power dissipation is limited by maximum junction to case thermal resistance:

### Equation 1

$$P_D = \Delta T / R_{\text{THJ-C}}$$

considering  $\Delta T = T_J - T_C = 125\text{ }^\circ\text{C} - 75\text{ }^\circ\text{C} = 50\text{ }^\circ\text{C}$

- The conduction losses are:

### Equation 2

$$P_C = I_C * V_{\text{CE(SAT)}} * \delta$$

with 50% of duty cycle,  $V_{\text{CESAT}}$  typical value @ 125°C.

- Power dissipation during ON & OFF commutations is due to the switching frequency:

### Equation 3

$$P_{\text{SW}} = (E_{\text{ON}} + E_{\text{OFF}}) * \text{freq.}$$

Typical values @ 125°C for switching losses are used (test conditions:  $V_{\text{CE}} = 480\text{V}$ ,  $V_{\text{GE}} = 15\text{V}$ ,  $R_G = 10\text{ Ohm}$ ). Furthermore, diode recovery energy is included in the  $E_{\text{ON}}$  (see [Note 1](#)), while the tail of the collector current is included in the  $E_{\text{OFF}}$  measurements.



## 4 Package mechanical data

In order to meet environmental requirements, ST offers these devices in different grades of ECOPACK<sup>®</sup> packages, depending on their level of environmental compliance. ECOPACK<sup>®</sup> specifications, grade definitions and product status are available at: [www.st.com](http://www.st.com). ECOPACK is an ST trademark.

Table 9. TO-220FP mechanical data

Dim.	mm		
	Min.	Typ.	Max.
A	4.4		4.6
B	2.5		2.7
D	2.5		2.75
E	0.45		0.7
F	0.75		1
F1	1.15		1.70
F2	1.15		1.70
G	4.95		5.2
G1	2.4		2.7
H	10		10.4
L2		16	
L3	28.6		30.6
L4	9.8		10.6
L5	2.9		3.6
L6	15.9		16.4
L7	9		9.3
Dia	3		3.2

Figure 23. TO-220FP drawing

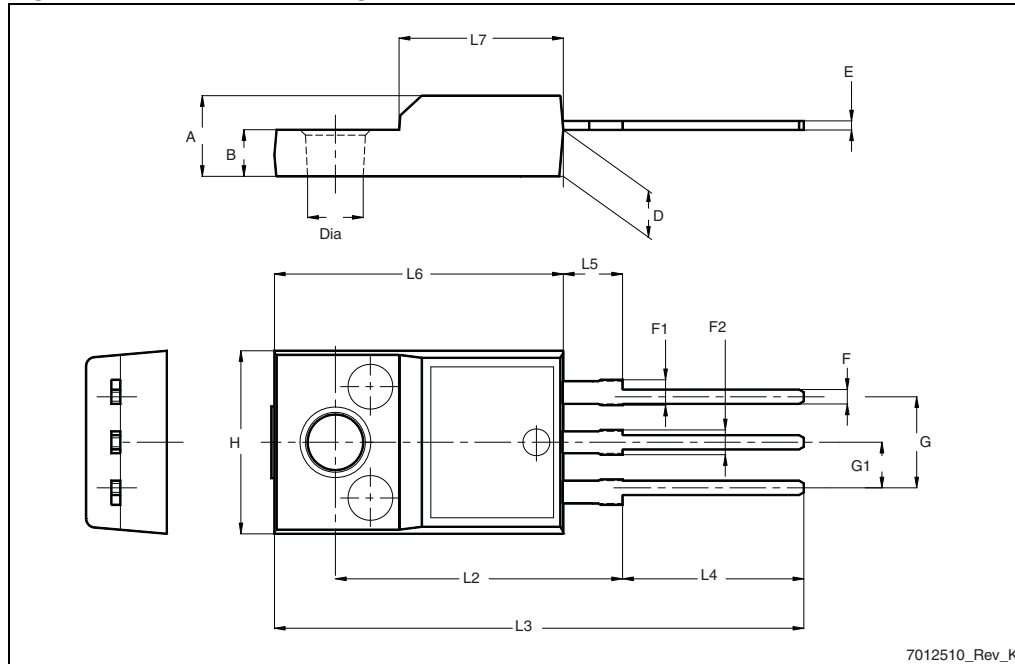

TO-220 type A mechanical data

Dim	mm		
	Min	Typ	Max
A	4.40		4.60
b	0.61		0.88
b1	1.14		1.70
c	0.48		0.70
D	15.25		15.75
D1		1.27	
E	10		10.40
e	2.40		2.70
e1	4.95		5.15
F	1.23		1.32
H1	6.20		6.60
J1	2.40		2.72
L	13		14
L1	3.50		3.93
L20		16.40	
L30		28.90	
∅P	3.75		3.85
Q	2.65		2.95

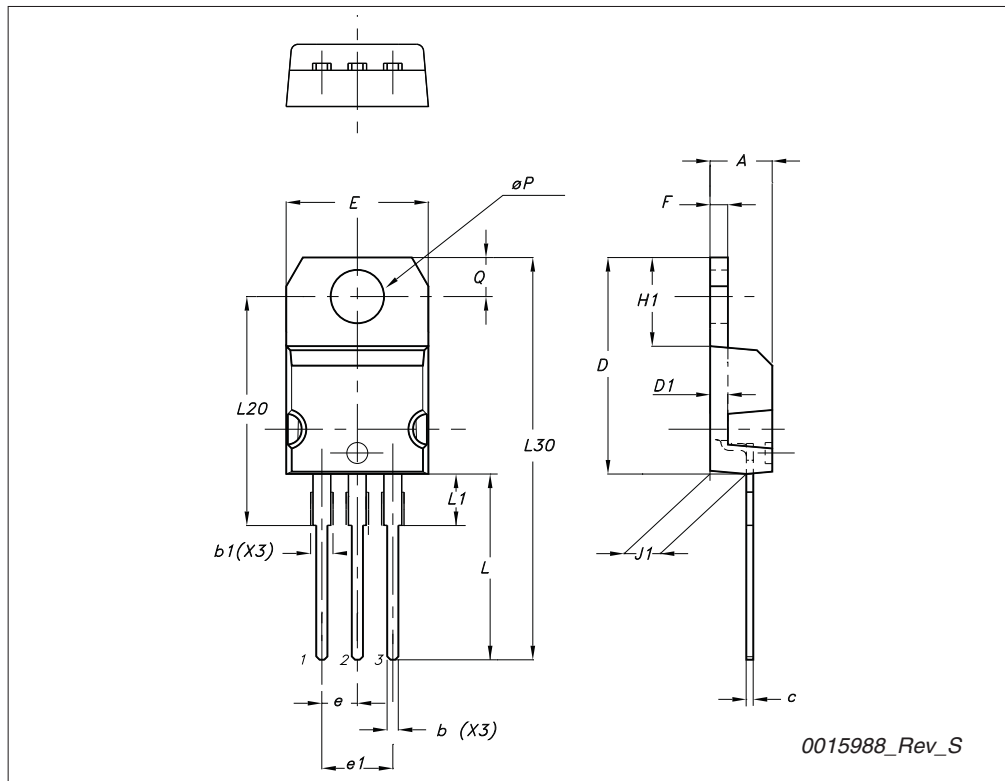

## 5 Revision history

**Table 10. Document revision history**

Date	Revision	Changes
02-Jul-2007	1	First release
13-Aug-2007	2	From target to preliminary version
18-Sep-2007	3	Added new section: <i>Electrical characteristics (curves)</i>
05-Nov-2010	4	<ul style="list-style-type: none"><li>– Cover page has been updated</li><li>– Modified gate threshold voltage range on <i>Table 4: Static</i></li><li>– Updated TO-220 mechanical data</li><li>– Added new package, mechanical data: TO-220FP</li></ul>

**Please Read Carefully:**

Information in this document is provided solely in connection with ST products. STMicroelectronics NV and its subsidiaries ("ST") reserve the right to make changes, corrections, modifications or improvements, to this document, and the products and services described herein at any time, without notice.

All ST products are sold pursuant to ST's terms and conditions of sale.

Purchasers are solely responsible for the choice, selection and use of the ST products and services described herein, and ST assumes no liability whatsoever relating to the choice, selection or use of the ST products and services described herein.

No license, express or implied, by estoppel or otherwise, to any intellectual property rights is granted under this document. If any part of this document refers to any third party products or services it shall not be deemed a license grant by ST for the use of such third party products or services, or any intellectual property contained therein or considered as a warranty covering the use in any manner whatsoever of such third party products or services or any intellectual property contained therein.

**UNLESS OTHERWISE SET FORTH IN ST'S TERMS AND CONDITIONS OF SALE ST DISCLAIMS ANY EXPRESS OR IMPLIED WARRANTY WITH RESPECT TO THE USE AND/OR SALE OF ST PRODUCTS INCLUDING WITHOUT LIMITATION IMPLIED WARRANTIES OF MERCHANTABILITY, FITNESS FOR A PARTICULAR PURPOSE (AND THEIR EQUIVALENTS UNDER THE LAWS OF ANY JURISDICTION), OR INFRINGEMENT OF ANY PATENT, COPYRIGHT OR OTHER INTELLECTUAL PROPERTY RIGHT.**

**UNLESS EXPRESSLY APPROVED IN WRITING BY AN AUTHORIZED ST REPRESENTATIVE, ST PRODUCTS ARE NOT RECOMMENDED, AUTHORIZED OR WARRANTED FOR USE IN MILITARY, AIR CRAFT, SPACE, LIFE SAVING, OR LIFE SUSTAINING APPLICATIONS, NOR IN PRODUCTS OR SYSTEMS WHERE FAILURE OR MALFUNCTION MAY RESULT IN PERSONAL INJURY, DEATH, OR SEVERE PROPERTY OR ENVIRONMENTAL DAMAGE. ST PRODUCTS WHICH ARE NOT SPECIFIED AS "AUTOMOTIVE GRADE" MAY ONLY BE USED IN AUTOMOTIVE APPLICATIONS AT USER'S OWN RISK.**

Resale of ST products with provisions different from the statements and/or technical features set forth in this document shall immediately void any warranty granted by ST for the ST product or service described herein and shall not create or extend in any manner whatsoever, any liability of ST.

ST and the ST logo are trademarks or registered trademarks of ST in various countries.

Information in this document supersedes and replaces all information previously supplied.

The ST logo is a registered trademark of STMicroelectronics. All other names are the property of their respective owners.

© 2010 STMicroelectronics - All rights reserved

STMicroelectronics group of companies

Australia - Belgium - Brazil - Canada - China - Czech Republic - Finland - France - Germany - Hong Kong - India - Israel - Italy - Japan - Malaysia - Malta - Morocco - Philippines - Singapore - Spain - Sweden - Switzerland - United Kingdom - United States of America

[www.st.com](http://www.st.com)

