

Utilizing the latest Non-Punch Through (NPT) Field Stop technology, these IGBT's have a very short, low amplitude tail current and low Eoff. The Trench Gate design results in superior  $V_{CE(on)}$  performance. Easy paralleling results from very tight parameter distribution and slightly positive  $V_{CE(on)}$  temperature coefficient. Built-in gate resistance ensures ultra-reliable operation. Low gate charge simplifies gate drive design and minimizes losses.

- 1200V NPT Field Stop
- Trench Gate: Low  $V_{CE(on)}$
- Easy Paralleling
- 10 $\mu$ s Short Circuit Capability
- Intergrated Gate Resistor: Low EMI, High Reliability

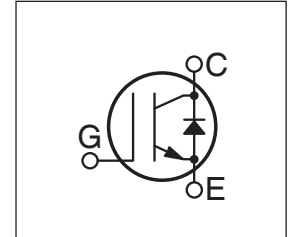
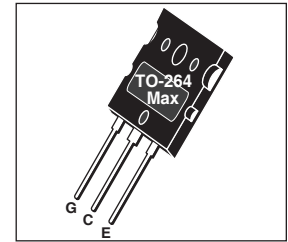

**Applications: Welding, Inductive Heating, Solar Inverters, SMPS, Motor drives, UPS**

### MAXIMUM RATINGS

All Ratings:  $T_C = 25^\circ\text{C}$  unless otherwise specified.

Symbol	Parameter	APT50GN120L2DQ2(G)	UNIT
$V_{CES}$	Collector-Emitter Voltage	1200	Volts
$V_{GE}$	Gate-Emitter Voltage	$\pm 30$	
$I_{C1}$	Continuous Collector Current <sup>③</sup> @ $T_C = 25^\circ\text{C}$	134	Amps
$I_{C2}$	Continuous Collector Current @ $T_C = 110^\circ\text{C}$	66	
$I_{CM}$	Pulsed Collector Current <sup>①</sup> @ $T_C = 150^\circ\text{C}$	150	
SSOA	Switching Safe Operating Area @ $T_J = 150^\circ\text{C}$	150A @ 1200V	
$P_D$	Total Power Dissipation	543	Watts
$T_J, T_{STG}$	Operating and Storage Junction Temperature Range	-55 to 150	$^\circ\text{C}$
$T_L$	Max. Lead Temp. for Soldering: 0.063" from Case for 10 Sec.	300	

### STATIC ELECTRICAL CHARACTERISTICS

Symbol	Characteristic / Test Conditions	MIN	TYP	MAX	Units
$V_{(BR)CES}$	Collector-Emitter Breakdown Voltage ( $V_{GE} = 0V, I_C = 400\mu\text{A}$ )	1200			Volts
$V_{GE(TH)}$	Gate Threshold Voltage ( $V_{CE} = V_{GE}, I_C = 2\text{mA}, T_J = 25^\circ\text{C}$ )	5	5.8	6.5	
$V_{CE(ON)}$	Collector-Emitter On Voltage ( $V_{GE} = 15V, I_C = 50A, T_J = 25^\circ\text{C}$ )	1.4	1.7	2.1	
	Collector-Emitter On Voltage ( $V_{GE} = 15V, I_C = 50A, T_J = 125^\circ\text{C}$ )		1.9		
$I_{CES}$	Collector Cut-off Current ( $V_{CE} = 1200V, V_{GE} = 0V, T_J = 25^\circ\text{C}$ ) <sup>②</sup>			200	$\mu\text{A}$
	Collector Cut-off Current ( $V_{CE} = 1200V, V_{GE} = 0V, T_J = 125^\circ\text{C}$ ) <sup>②</sup>			TBD	
$I_{GES}$	Gate-Emitter Leakage Current ( $V_{GE} = \pm 20V$ )			600	nA
$R_{GINT}$	Intergrated Gate Resistor		4		$\Omega$

 **CAUTION:** These Devices are Sensitive to Electrostatic Discharge. Proper Handling Procedures Should Be Followed.

## DYNAMIC CHARACTERISTICS

APT50GN120L2DQ2(G)

Symbol	Characteristic	Test Conditions	MIN	TYP	MAX	UNIT	
$C_{ies}$	Input Capacitance	<b>Capacitance</b> $V_{GE} = 0V, V_{CE} = 25V$ $f = 1 \text{ MHz}$		3600		pF	
$C_{oes}$	Output Capacitance			210			
$C_{res}$	Reverse Transfer Capacitance			170			
$V_{GEP}$	Gate-to-Emitter Plateau Voltage	Gate Charge		9.5		V	
$Q_g$	Total Gate Charge <sup>③</sup>	$V_{GE} = 15V$		315		nC	
$Q_{ge}$	Gate-Emitter Charge	$V_{CE} = 600V$		20			
$Q_{gc}$	Gate-Collector ("Miller") Charge	$I_C = 50A$		190			
SSOA	Switching Safe Operating Area	$T_J = 150^\circ\text{C}, R_G = 2.2\Omega^{\text{⑦}}, V_{GE} = 15V, L = 100\mu\text{H}, V_{CE} = 1200V$	150			A	
SCSOA	Short Circuit Safe Operating Area	$V_{CC} = 960V, V_{GE} = 15V, T_J = 125^\circ\text{C}, R_G = 2.2\Omega^{\text{⑦}}$	10			$\mu\text{s}$	
$t_{d(on)}$	Turn-on Delay Time	<b>Inductive Switching (25°C)</b>  $V_{CC} = 800V$ $V_{GE} = 15V$ $I_C = 50A$ $R_G = 2.2\Omega^{\text{⑦}}$ $T_J = +25^\circ\text{C}$		28		ns	
$t_r$	Current Rise Time			27			
$t_{d(off)}$	Turn-off Delay Time			320			
$t_f$	Current Fall Time			115			
$E_{on1}$	Turn-on Switching Energy <sup>④</sup>				TBD		$\mu\text{J}$
$E_{on2}$	Turn-on Switching Energy (Diode) <sup>⑤</sup>				3900		
$E_{off}$	Turn-off Switching Energy <sup>⑥</sup>				4495		
$t_{d(on)}$	Turn-on Delay Time		<b>Inductive Switching (125°C)</b>  $V_{CC} = 800V$ $V_{GE} = 15V$ $I_C = 50A$ $R_G = 2.2\Omega^{\text{⑦}}$ $T_J = +125^\circ\text{C}$		28		ns
$t_r$	Current Rise Time			27			
$t_{d(off)}$	Turn-off Delay Time			395			
$t_f$	Current Fall Time			205			
$E_{on1}$	Turn-on Switching Energy <sup>④</sup>				TBD		$\mu\text{J}$
$E_{on2}$	Turn-on Switching Energy (Diode) <sup>⑤</sup>				5660		
$E_{off}$	Turn-off Switching Energy <sup>⑥</sup>				6795		

## THERMAL AND MECHANICAL CHARACTERISTICS

Symbol	Characteristic	MIN	TYP	MAX	UNIT
$R_{\theta JC}$	Junction to Case (IGBT)			.23	$^\circ\text{C/W}$
$R_{\theta JC}$	Junction to Case (DIODE)			.61	
$W_T$	Package Weight		5.9		gm

- ① Repetitive Rating: Pulse width limited by maximum junction temperature.
- ② For Combi devices,  $I_{ces}$  includes both IGBT and FRED leakages
- ③ See MIL-STD-750 Method 3471.
- ④  $E_{on1}$  is the clamped inductive turn-on-energy of the IGBT only, without the effect of a commutating diode reverse recovery current adding to the IGBT turn-on loss. (See Figure 24.)
- ⑤  $E_{on2}$  is the clamped inductive turn-on energy that includes a commutating diode reverse recovery current in the IGBT turn-on switching loss. (See Figures 21, 22.)
- ⑥  $E_{off}$  is the clamped inductive turn-off energy measured in accordance with JEDEC standard JESD24-1. (See Figures 21, 23.)
- ⑦  $R_G$  is external gate resistance, not including  $R_{Gint}$  nor gate driver impedance.
- ⑧ Continuous current limited by package lead temperature.

APT Reserves the right to change, without notice, the specifications and information contained herein.

# TYPICAL PERFORMANCE CURVES

APT50GN120L2DQ2(G)

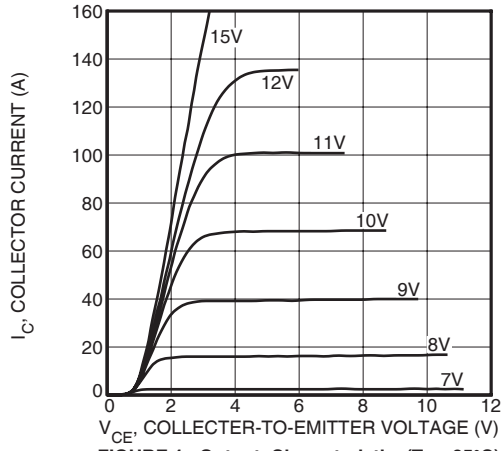

FIGURE 1, Output Characteristics ( $T_J = 25^\circ\text{C}$ )

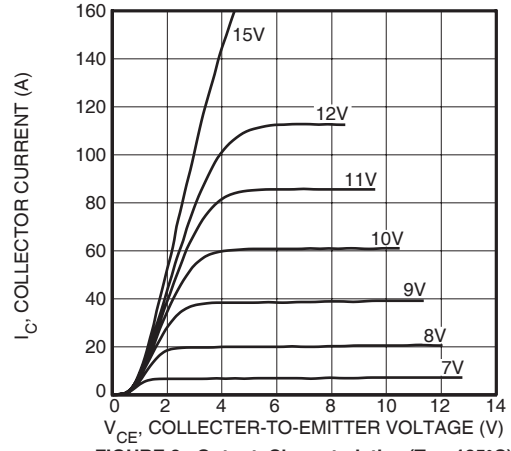

FIGURE 2, Output Characteristics ( $T_J = 125^\circ\text{C}$ )

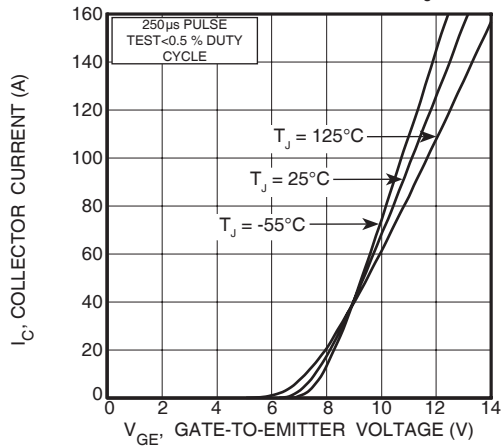

FIGURE 3, Transfer Characteristics

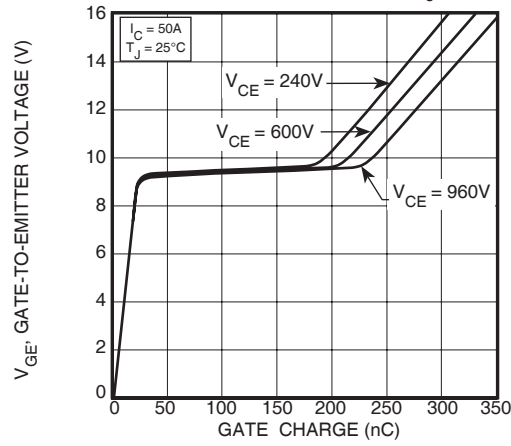

FIGURE 4, Gate Charge

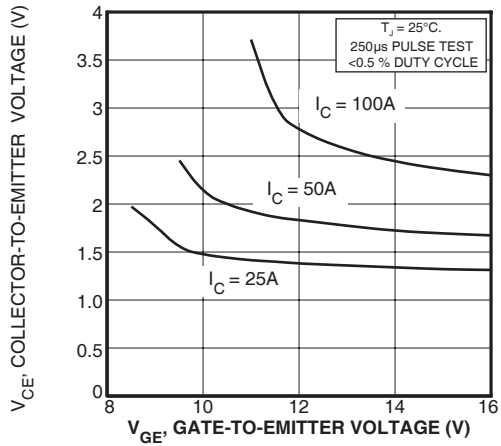

FIGURE 5, On State Voltage vs Gate-to-Emitter Voltage

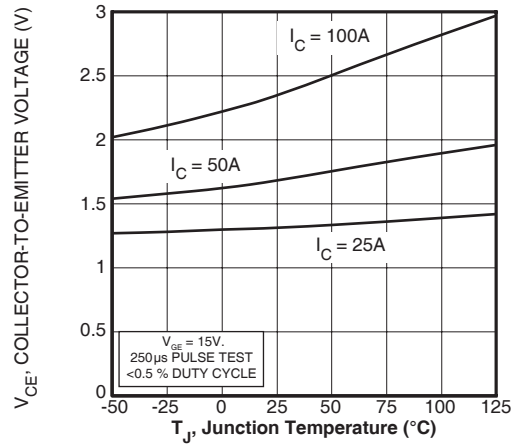

FIGURE 6, On State Voltage vs Junction Temperature

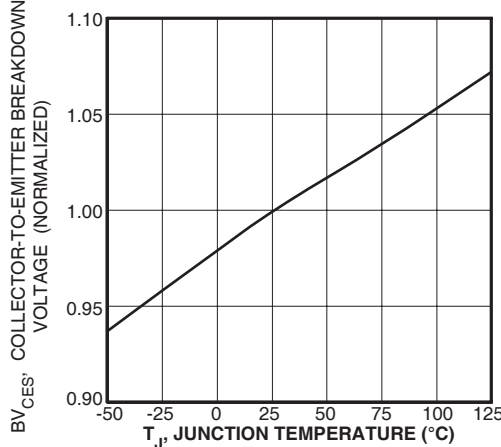

FIGURE 7, Breakdown Voltage vs. Junction Temperature

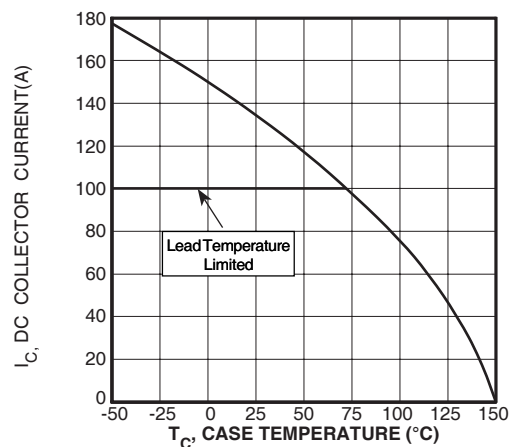

FIGURE 8, DC Collector Current vs Case Temperature

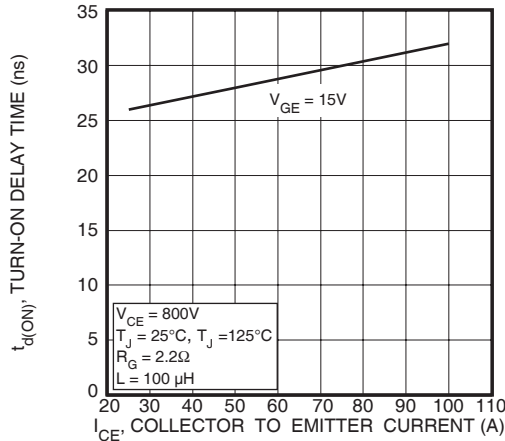

FIGURE 9, Turn-On Delay Time vs Collector Current

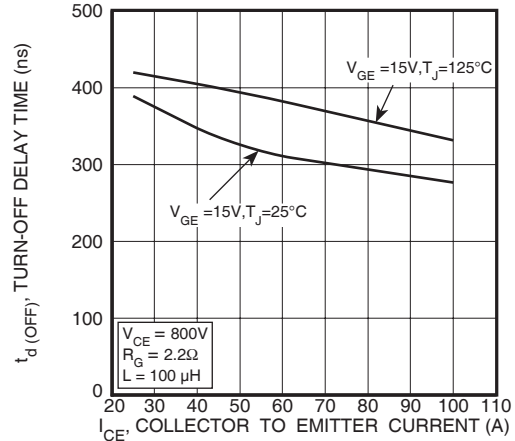

FIGURE 10, Turn-Off Delay Time vs Collector Current

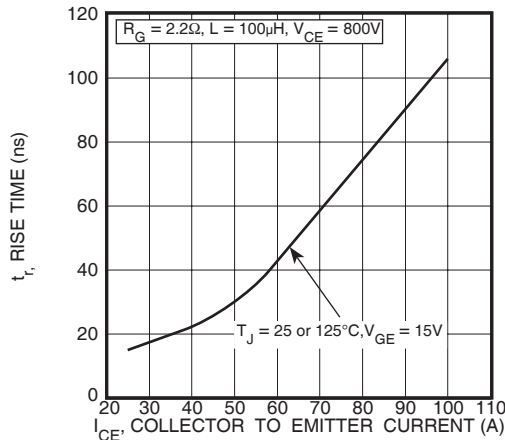

FIGURE 11, Current Rise Time vs Collector Current

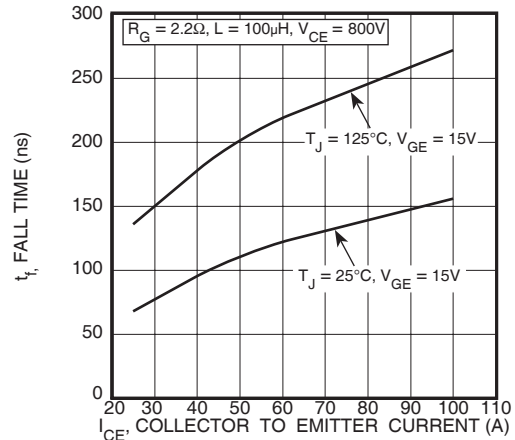

FIGURE 12, Current Fall Time vs Collector Current

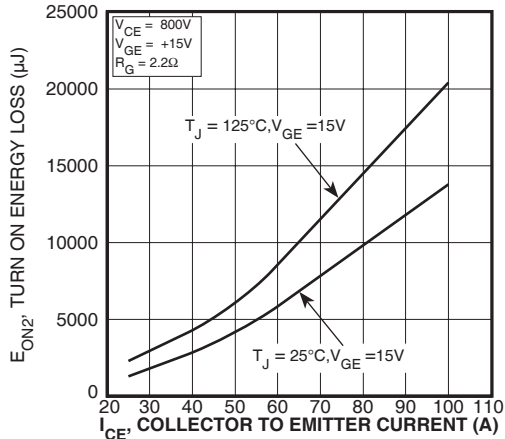

FIGURE 13, Turn-On Energy Loss vs Collector Current

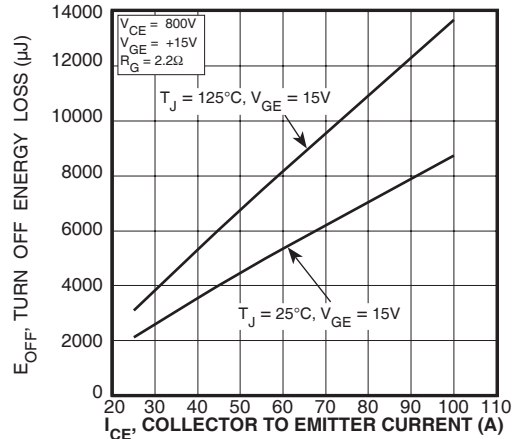

FIGURE 14, Turn Off Energy Loss vs Collector Current

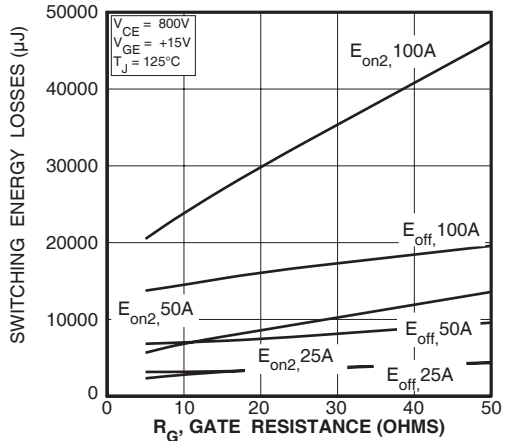

FIGURE 15, Switching Energy Losses vs. Gate Resistance

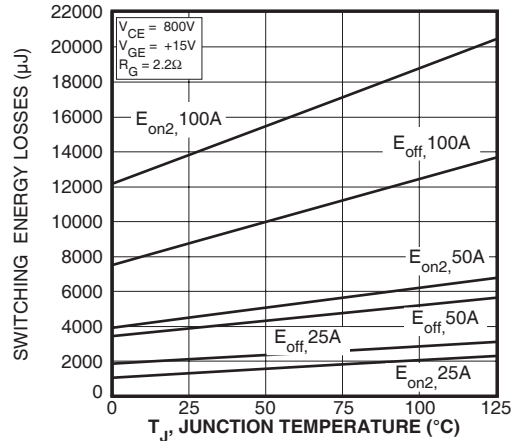

FIGURE 16, Switching Energy Losses vs Junction Temperature

**TYPICAL PERFORMANCE CURVES**

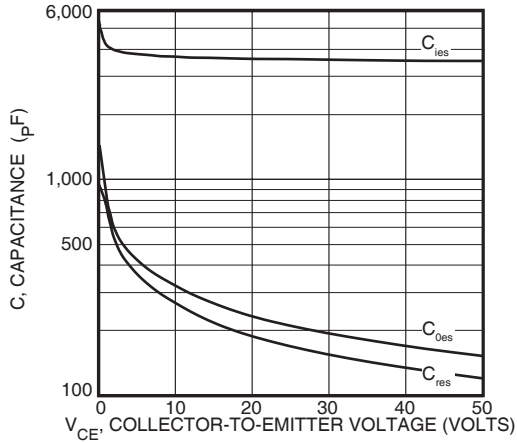

Figure 17, Capacitance vs Collector-To-Emitter Voltage

**APT50GN120L2DQ2(G)**

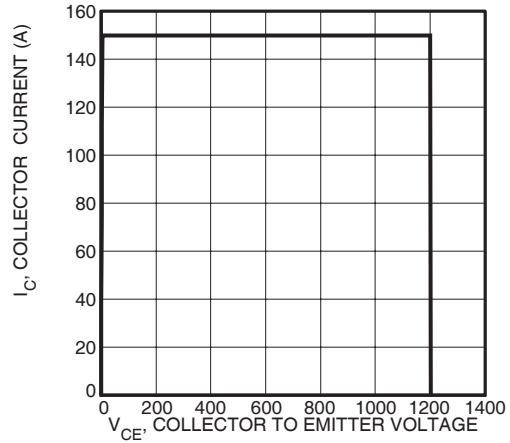

Figure 18, Minimum Switching Safe Operating Area

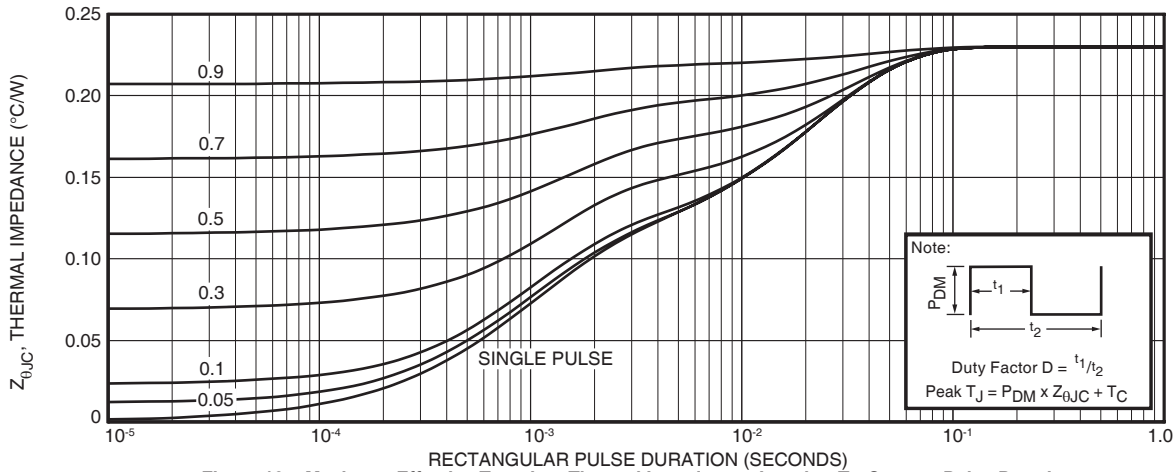

Figure 19a, Maximum Effective Transient Thermal Impedance, Junction-To-Case vs Pulse Duration

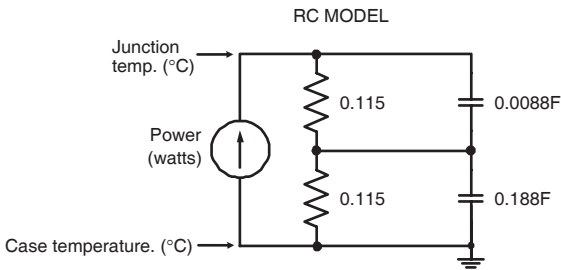

FIGURE 19b, TRANSIENT THERMAL IMPEDANCE MODEL

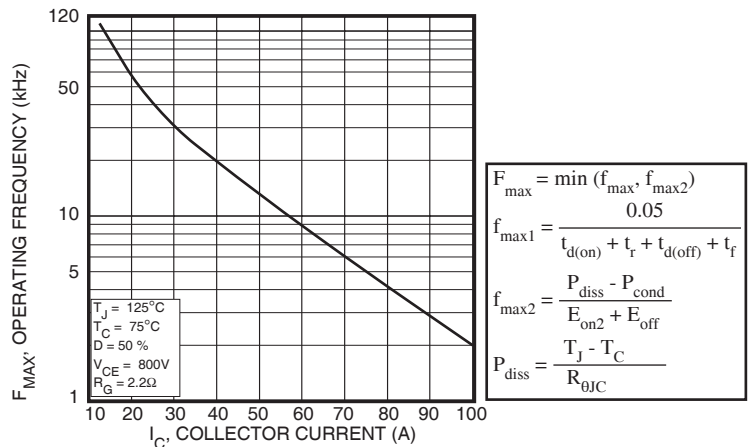

Figure 20, Operating Frequency vs Collector Current

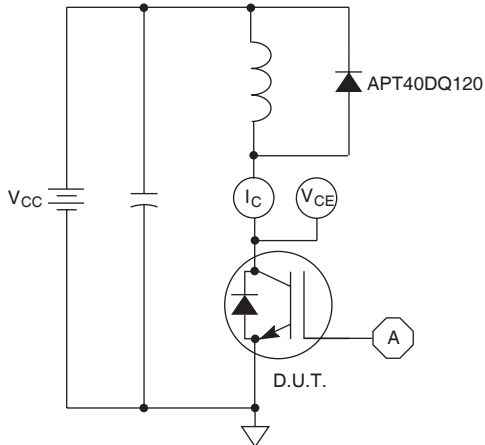

Figure 21, Inductive Switching Test Circuit

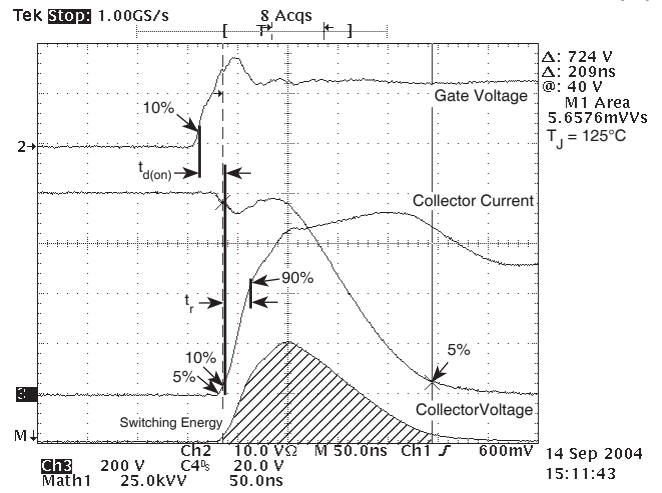

Figure 22, Turn-on Switching Waveforms and Definitions

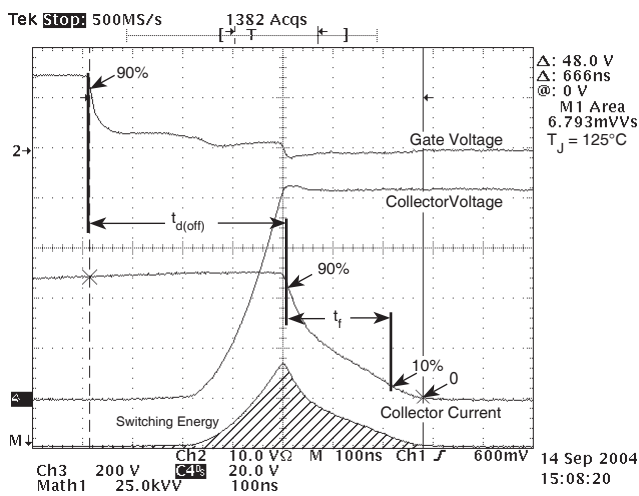

Figure 23, Turn-off Switching Waveforms and Definitions

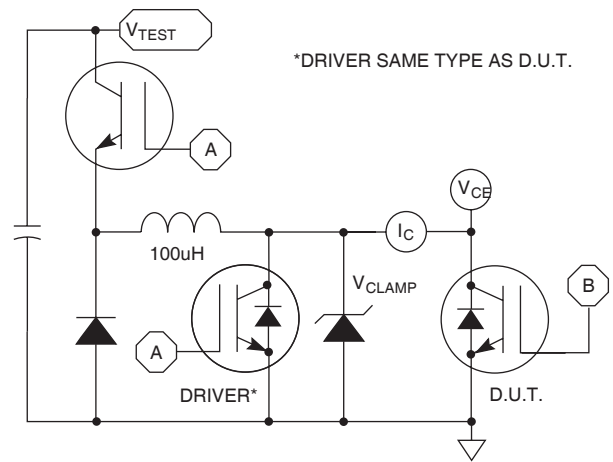

Figure 24, E<sub>ON1</sub> Test Circuit

# ULTRAFAST SOFT RECOVERY ANTI-PARALLEL DIODE

**MAXIMUM RATINGS**

All Ratings:  $T_C = 25^\circ\text{C}$  unless otherwise specified.

Symbol	Characteristic / Test Conditions	APT50GP120L2DQ2(G)		UNIT
$I_F(\text{AV})$	Maximum Average Forward Current ( $T_C = 112^\circ\text{C}$ , Duty Cycle = 0.5)	40		Amps
$I_F(\text{RMS})$	RMS Forward Current (Square wave, 50% duty)	63		
$I_{\text{FSM}}$	Non-Repetitive Forward Surge Current ( $T_J = 45^\circ\text{C}$ , 8.3ms)	210		

**STATIC ELECTRICAL CHARACTERISTICS**

Symbol	Characteristic / Test Conditions	MIN	TYP	MAX	UNIT
$V_F$	Forward Voltage		$I_F = 50\text{A}$	2.9	Volts
			$I_F = 100\text{A}$	3.67	
			$I_F = 50\text{A}, T_J = 125^\circ\text{C}$	2.36	

**DYNAMIC CHARACTERISTICS**

Symbol	Characteristic	Test Conditions	MIN	TYP	MAX	UNIT
$t_{rr}$	Reverse Recovery Time	$I_F = 1\text{A}, di_F/dt = -100\text{A}/\mu\text{s}, V_R = 30\text{V}, T_J = 25^\circ\text{C}$	-	26		ns
$t_{rr}$	Reverse Recovery Time	$I_F = 40\text{A}, di_F/dt = -200\text{A}/\mu\text{s}, V_R = 800\text{V}, T_C = 25^\circ\text{C}$	-	350		
$Q_{rr}$	Reverse Recovery Charge		-	570		nC
$I_{RRM}$	Maximum Reverse Recovery Current		-	4	-	Amps
$t_{rr}$	Reverse Recovery Time	$I_F = 40\text{A}, di_F/dt = -200\text{A}/\mu\text{s}, V_R = 800\text{V}, T_C = 125^\circ\text{C}$	-	430		ns
$Q_{rr}$	Reverse Recovery Charge		-	2200		nC
$I_{RRM}$	Maximum Reverse Recovery Current		-	9	-	Amps
$t_{rr}$	Reverse Recovery Time	$I_F = 40\text{A}, di_F/dt = -1000\text{A}/\mu\text{s}, V_R = 800\text{V}, T_C = 125^\circ\text{C}$	-	210		ns
$Q_{rr}$	Reverse Recovery Charge		-	3400		nC
$I_{RRM}$	Maximum Reverse Recovery Current		-	29		Amps

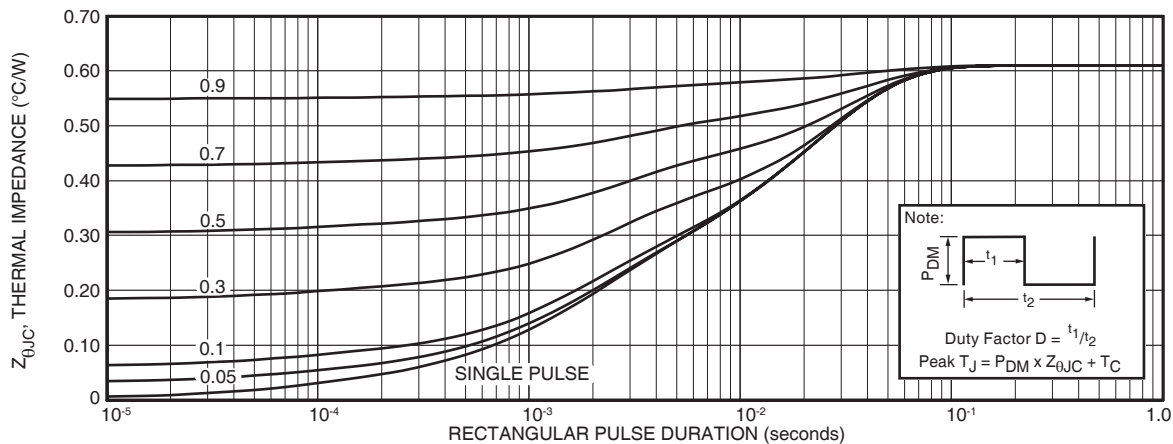

FIGURE 25a. MAXIMUM EFFECTIVE RECTANGULAR THERMAL IMPEDANCE, JUNCTION-TO-CASE vs. PULSE DURATION RC MODEL

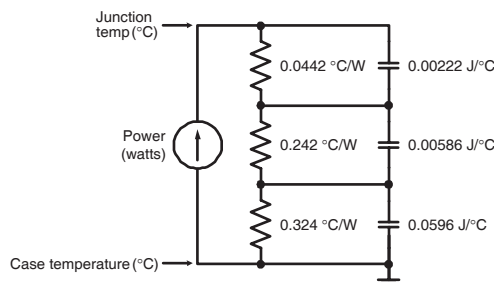

FIGURE 25b. TRANSIENT THERMAL IMPEDANCE MODEL

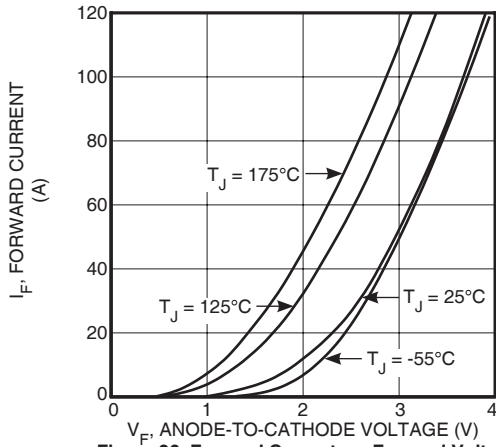

Figure 26. Forward Current vs. Forward Voltage

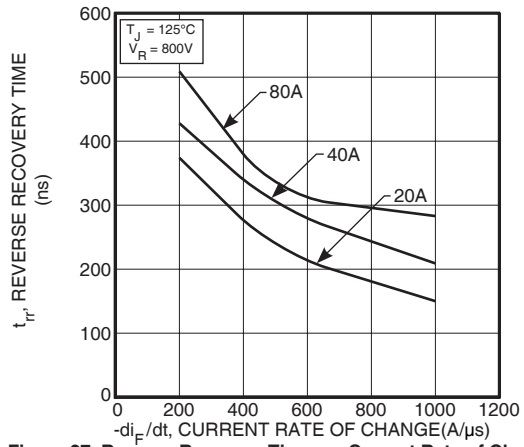

Figure 27. Reverse Recovery Time vs. Current Rate of Change



Figure 28. Reverse Recovery Charge vs. Current Rate of Change



Figure 29. Reverse Recovery Current vs. Current Rate of Change



Figure 30. Dynamic Parameters vs. Junction Temperature



Figure 31. Maximum Average Forward Current vs. Case Temperature



Figure 32. Junction Capacitance vs. Reverse Voltage



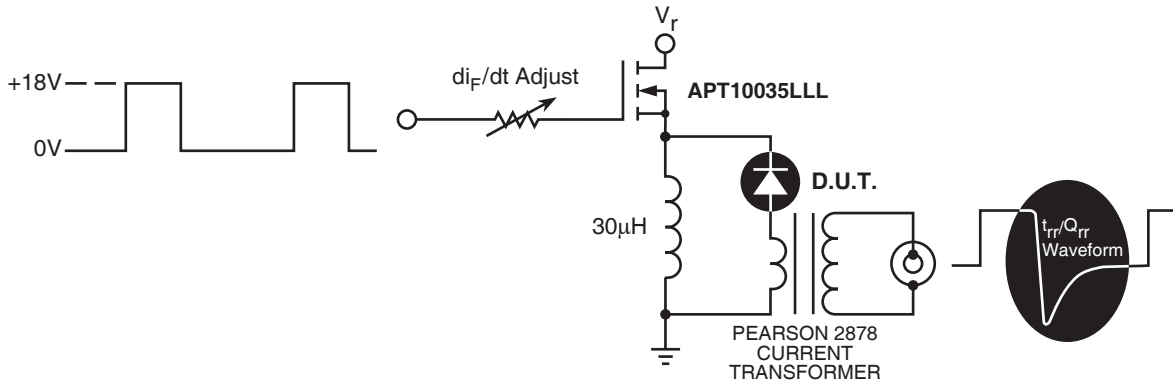

Figure 33. Diode Test Circuit

- 1  $I_F$  - Forward Conduction Current
- 2  $di_F/dt$  - Rate of Diode Current Change Through Zero Crossing.
- 3  $I_{RRM}$  - Maximum Reverse Recovery Current.
- 4  $t_{rr}$  - Reverse Recovery Time, measured from zero crossing where diode current goes from positive to negative, to the point at which the straight line through  $I_{RRM}$  and  $0.25 \cdot I_{RRM}$  passes through zero.
- 5  $Q_{rr}$  - Area Under the Curve Defined by  $I_{RRM}$  and  $t_{rr}$ .



Figure 34, Diode Reverse Recovery Waveform and Definitions

### TO-264MAX (L2) Package Outline

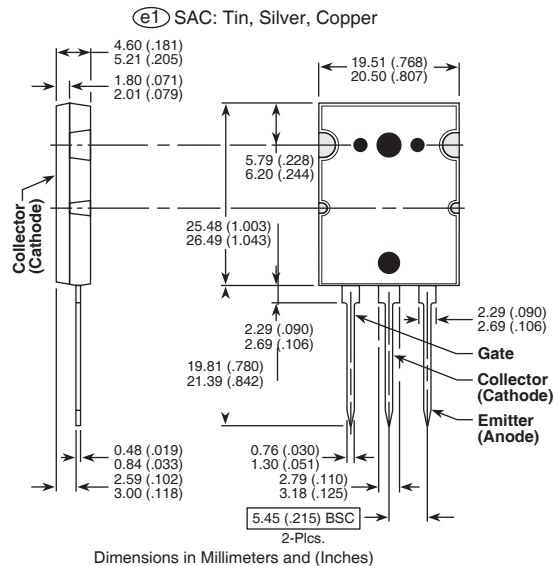

APT's products are covered by one or more of U.S. patents 4,895,810 5,045,903 5,089,434 5,182,234 5,019,522

5,262,336 6,503,786 5,256,583 4,748,103 5,283,202 5,231,474 5,434,095 5,528,058 and foreign patents. US and Foreign patents pending. All Rights Reserved.