



FGH40N60UFD

600V, 40A Field Stop IGBT

Features

- High current capability
- Low saturation voltage: $V_{CE(sat)} = 1.8V @ I_C = 40A$
- High input impedance
- Fast switching
- RoHS compliant

General Description

Using Novel Field Stop IGBT Technology, Fairchild's new series of Field Stop IGBTs offer the optimum performance for Induction Heating, UPS, SMPS and PFC applications where low conduction and switching losses are essential.

Applications

- Induction Heating, UPS, SMPS, PFC

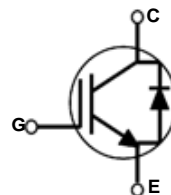
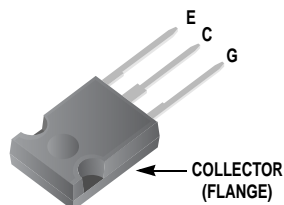

Absolute Maximum Ratings

| Symbol | Description | Ratings | Units |
|-------------|---|-------------|------------|
| V_{CES} | Collector to Emitter Voltage | 600 | V |
| V_{GES} | Gate to Emitter Voltage | ± 20 | V |
| I_C | Collector Current @ $T_C = 25^\circ C$ | 80 | A |
| | Collector Current @ $T_C = 100^\circ C$ | 40 | A |
| $I_{CM(1)}$ | Pulsed Collector Current @ $T_C = 25^\circ C$ | 120 | A |
| I_F | Diode Continuous Forward Current @ $T_C = 25^\circ C$ | 40 | A |
| | Diode Continuous Forward Current @ $T_C = 100^\circ C$ | 20 | A |
| I_{FM} | Diode Maximum Forward Current | 80 | A |
| P_D | Maximum Power Dissipation @ $T_C = 25^\circ C$ | 290 | W |
| | Maximum Power Dissipation @ $T_C = 100^\circ C$ | 116 | W |
| T_J | Operating Junction Temperature | -55 to +150 | $^\circ C$ |
| T_{stg} | Storage Temperature Range | -55 to +150 | $^\circ C$ |
| T_L | Maximum Lead Temp. for soldering Purposes, 1/8" from case for 5 seconds | 300 | $^\circ C$ |

Notes:

1: Repetitive rating: Pulse width limited by max. junction temperature

Thermal Characteristics

| Symbol | Parameter | Typ. | Max. | Units |
|------------------------|---|------|------|--------------|
| $R_{\theta JC}(IGBT)$ | Thermal Resistance, Junction to Case | - | 0.43 | $^\circ C/W$ |
| $R_{\theta JC}(Diode)$ | Thermal Resistance, Junction to Case | - | 1.45 | $^\circ C/W$ |
| $R_{\theta JA}$ | Thermal Resistance, Junction to Ambient | - | 40 | $^\circ C/W$ |

Package Marking and Ordering Information

| Device Marking | Device | Package | Packaging Type | Qty per Tube | Max Qty per Box |
|----------------|---------------|---------|----------------|--------------|-----------------|
| FGH40N60UFD | FGH40N60UFDTU | TO-247 | Tube | 30ea | - |

Electrical Characteristics of the IGBT T_C = 25°C unless otherwise noted

| Symbol | Parameter | Test Conditions | Min. | Typ. | Max. | Units |
|--------------------------------------|--|---|------|------|------|-------|
| Off Characteristics | | | | | | |
| BV _{CES} | Collector to Emitter Breakdown Voltage | V _{GE} = 0V, I _C = 250μA | 600 | - | - | V |
| $\frac{\Delta BV_{CES}}{\Delta T_J}$ | Temperature Coefficient of Breakdown Voltage | V _{GE} = 0V, I _C = 250μA | - | 0.6 | - | V/°C |
| I _{CES} | Collector Cut-Off Current | V _{CE} = V _{CES} , V _{GE} = 0V | - | - | 250 | μA |
| I _{GES} | G-E Leakage Current | V _{GE} = V _{GES} , V _{CE} = 0V | - | - | ±400 | nA |
| On Characteristics | | | | | | |
| V _{GE(th)} | G-E Threshold Voltage | I _C = 250μA, V _{CE} = V _{GE} | 4.0 | 5.0 | 6.5 | V |
| V _{CE(sat)} | Collector to Emitter Saturation Voltage | I _C = 40A, V _{GE} = 15V | - | 1.8 | 2.4 | V |
| | | I _C = 40A, V _{GE} = 15V, T _C = 125°C | - | 2.0 | - | V |
| Dynamic Characteristics | | | | | | |
| C _{ies} | Input Capacitance | V _{CE} = 30V, V _{GE} = 0V, f = 1MHz | - | 2110 | - | pF |
| C _{oes} | Output Capacitance | | - | 200 | - | pF |
| C _{res} | Reverse Transfer Capacitance | | - | 60 | - | pF |
| Switching Characteristics | | | | | | |
| t _{d(on)} | Turn-On Delay Time | V _{CC} = 400V, I _C = 40A, R _G = 10Ω, V _{GE} = 15V, Inductive Load, T _C = 25°C | - | 24 | - | ns |
| t _r | Rise Time | | - | 44 | - | ns |
| t _{d(off)} | Turn-Off Delay Time | | - | 112 | - | ns |
| t _f | Fall Time | | - | 30 | 60 | ns |
| E _{on} | Turn-On Switching Loss | | - | 1.19 | - | mJ |
| E _{off} | Turn-Off Switching Loss | | - | 0.46 | - | mJ |
| E _{ts} | Total Switching Loss | | - | 1.65 | - | mJ |
| t _{d(on)} | Turn-On Delay Time | V _{CC} = 400V, I _C = 40A, R _G = 10Ω, V _{GE} = 15V, Inductive Load, T _C = 125°C | - | 24 | - | ns |
| t _r | Rise Time | | - | 45 | - | ns |
| t _{d(off)} | Turn-Off Delay Time | | - | 120 | - | ns |
| t _f | Fall Time | | - | 40 | - | ns |
| E _{on} | Turn-On Switching Loss | | - | 1.2 | - | mJ |
| E _{off} | Turn-Off Switching Loss | | - | 0.69 | - | mJ |
| E _{ts} | Total Switching Loss | | - | 1.89 | - | mJ |
| Q _g | Total Gate Charge | V _{CE} = 400V, I _C = 40A, V _{GE} = 15V | - | 120 | - | nC |
| Q _{ge} | Gate to Emitter Charge | | - | 14 | - | nC |
| Q _{gc} | Gate to Collector Charge | | - | 58 | - | nC |

Electrical Characteristics of the Diode T_C = 25°C unless otherwise noted

| Symbol | Parameter | Test Conditions | | Min. | Typ. | Max | Units |
|-----------------|-------------------------------|---|------------------------|------|------|-----|-------|
| V _{FM} | Diode Forward Voltage | I _F = 20A | T _C = 25°C | - | 1.95 | 2.6 | V |
| | | | T _C = 125°C | - | 1.85 | - | |
| t _{rr} | Diode Reverse Recovery Time | I _{ES} = 20A, dI _{ES} /dt = 200A/μs | T _C = 25°C | - | 45 | - | ns |
| | | | T _C = 125°C | - | 140 | - | |
| Q _{rr} | Diode Reverse Recovery Charge | | T _C = 25°C | - | 75 | - | nC |
| | | | T _C = 125°C | - | 375 | - | |

Typical Performance Characteristics

Figure 1. Typical Output Characteristics

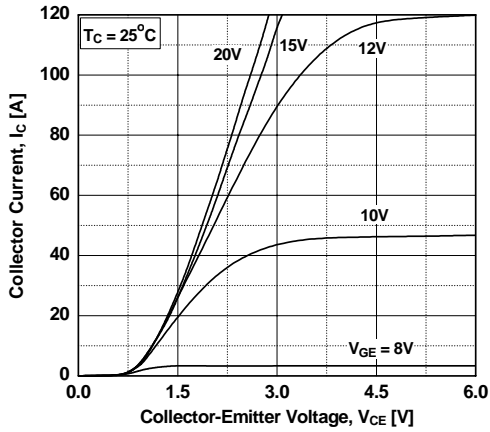

Figure 2. Typical Output Characteristics

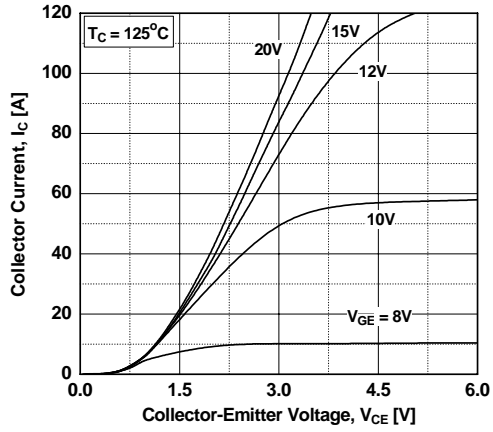

Figure 3. Typical Saturation Voltage Characteristics

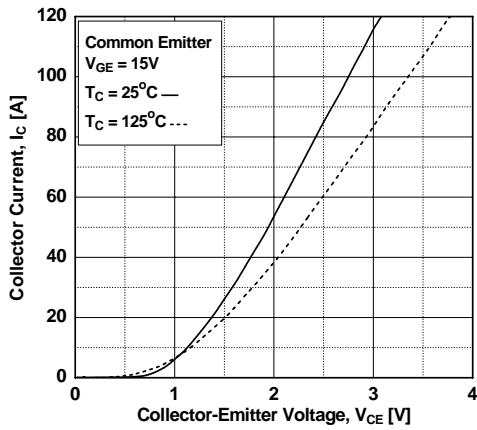

Figure 4. Transfer Characteristics

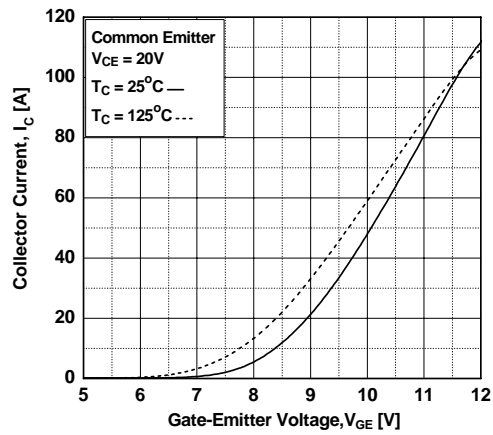

Figure 5. Saturation Voltage vs. Case Temperature at Variant Current Level

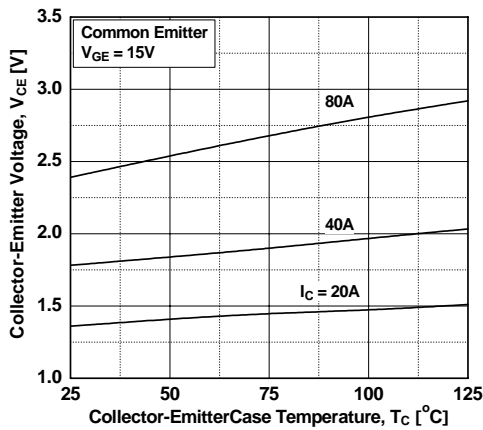
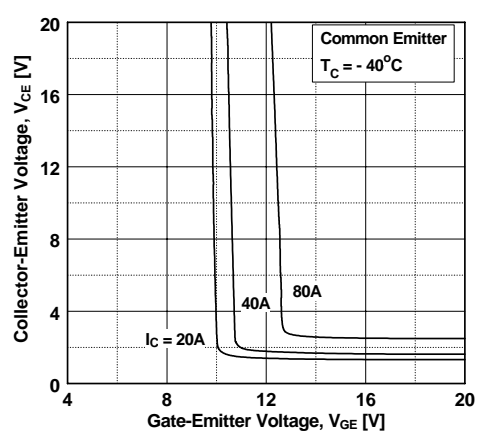

Figure 6. Saturation Voltage vs. Vge



Typical Performance Characteristics

Figure 7. Saturation Voltage vs. V_{GE}

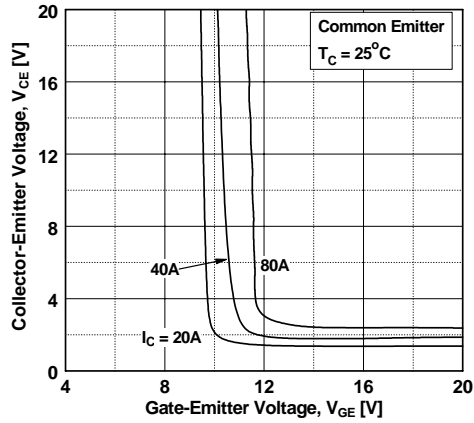

Figure 8. Saturation Voltage vs. V_{GE}

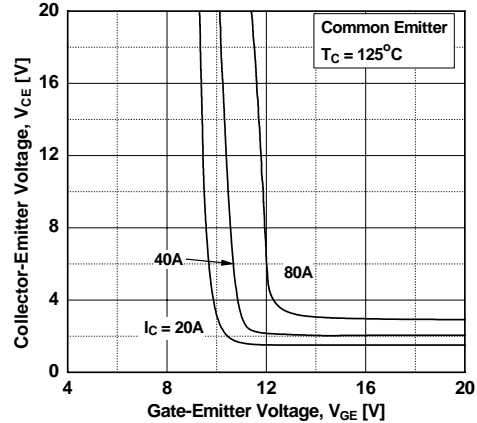

Figure 9. Capacitance Characteristics

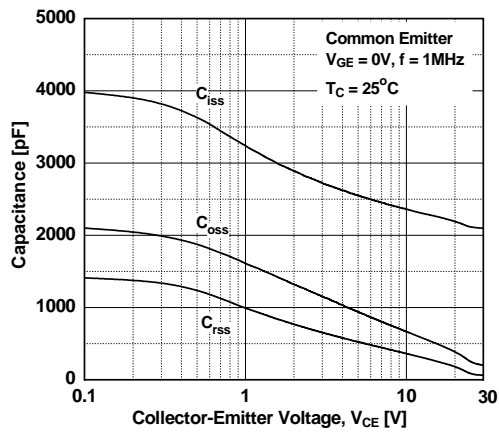

Figure 10. Gate charge Characteristics

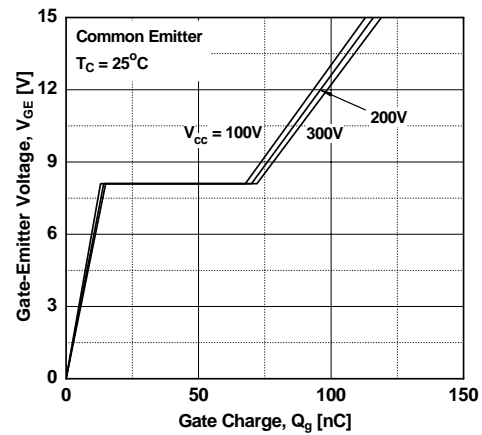

Figure 11. SOA Characteristics

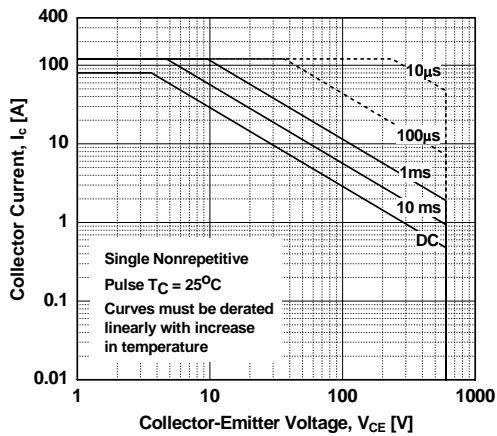
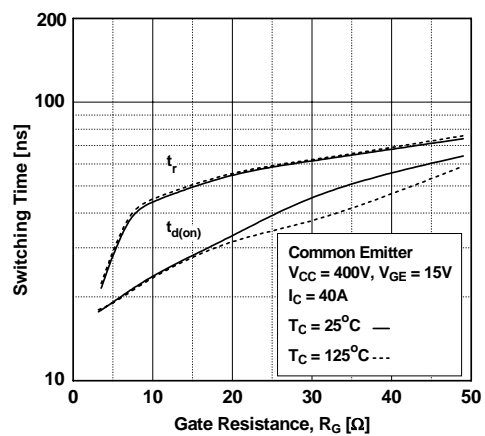

Figure 12. Turn-on Characteristics vs. Gate Resistance



Typical Performance Characteristics

Figure 13. Turn-off Characteristics vs. Gate Resistance

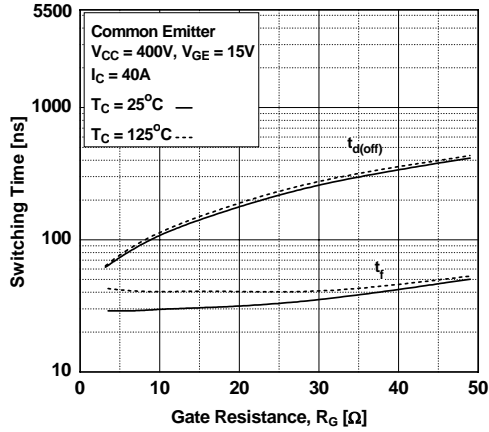

Figure 14. Turn-on Characteristics vs. Collector Current

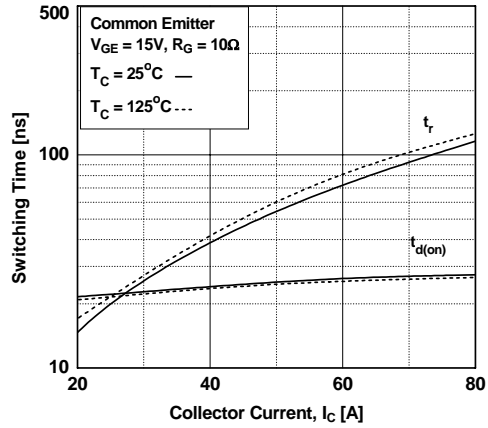

Figure 15. Turn-off Characteristics vs. Collector Current

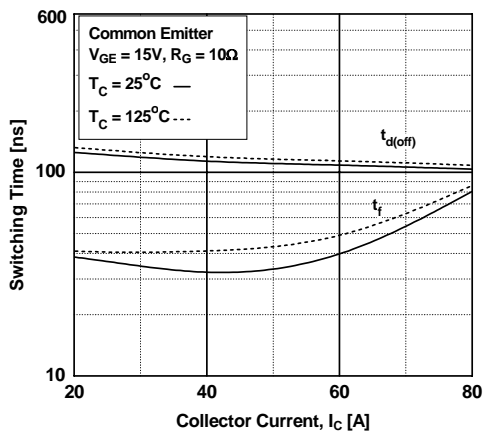

Figure 16. Switching Loss vs. Gate Resistance

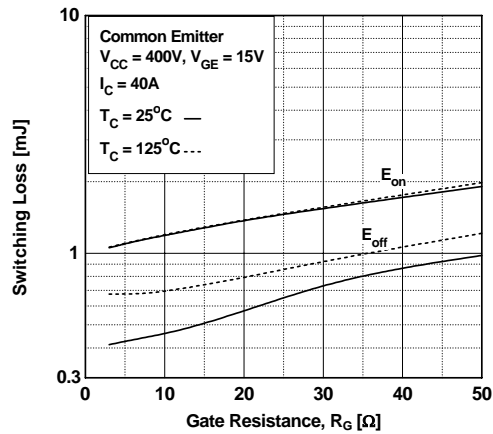

Figure 17. Switching Loss vs. Collector Current

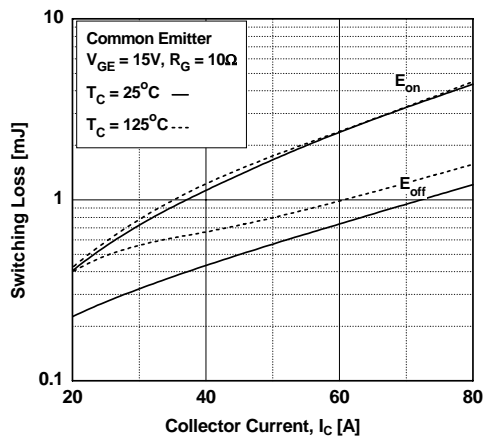
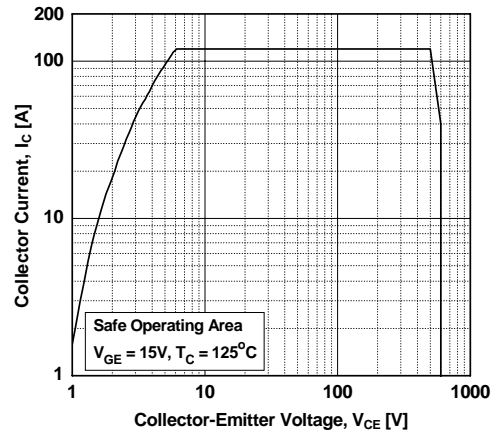

Figure 18. Turn off Switching SOA Characteristics



Typical Performance Characteristics

Figure 19. Forward Characteristics

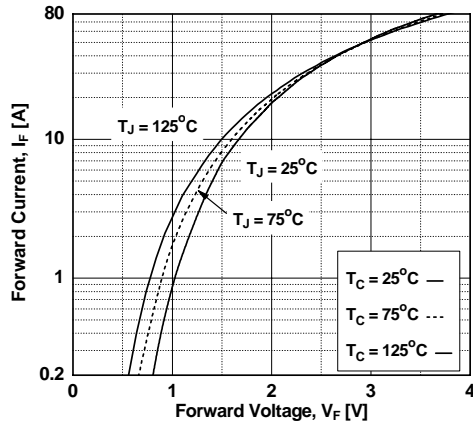

Figure 20. Typical Reverse Current vs. Reverse Voltage

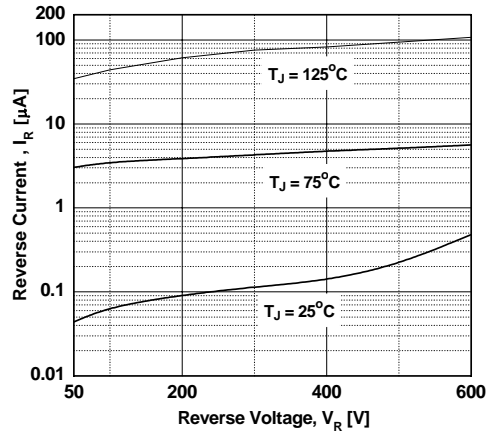

Figure 21. Stored Charge

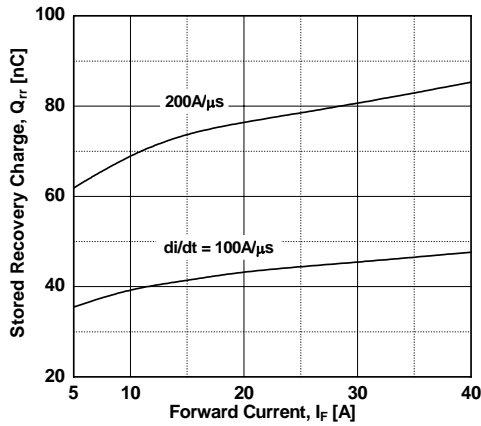

Figure 22. Reverse Recovery Time

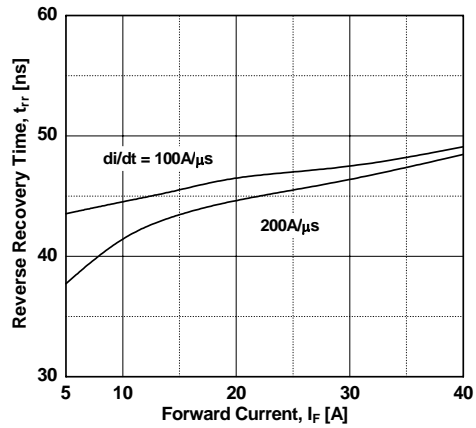
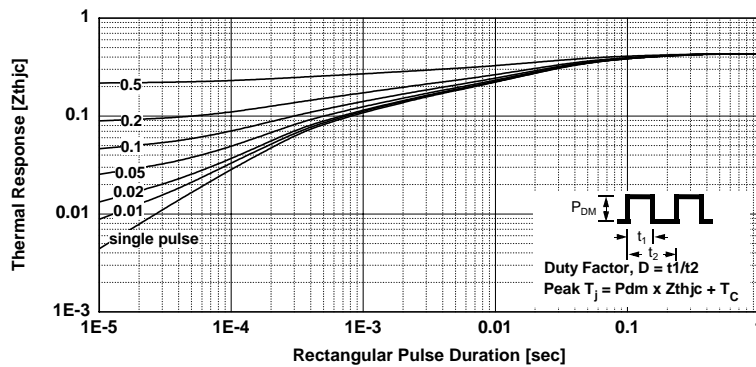
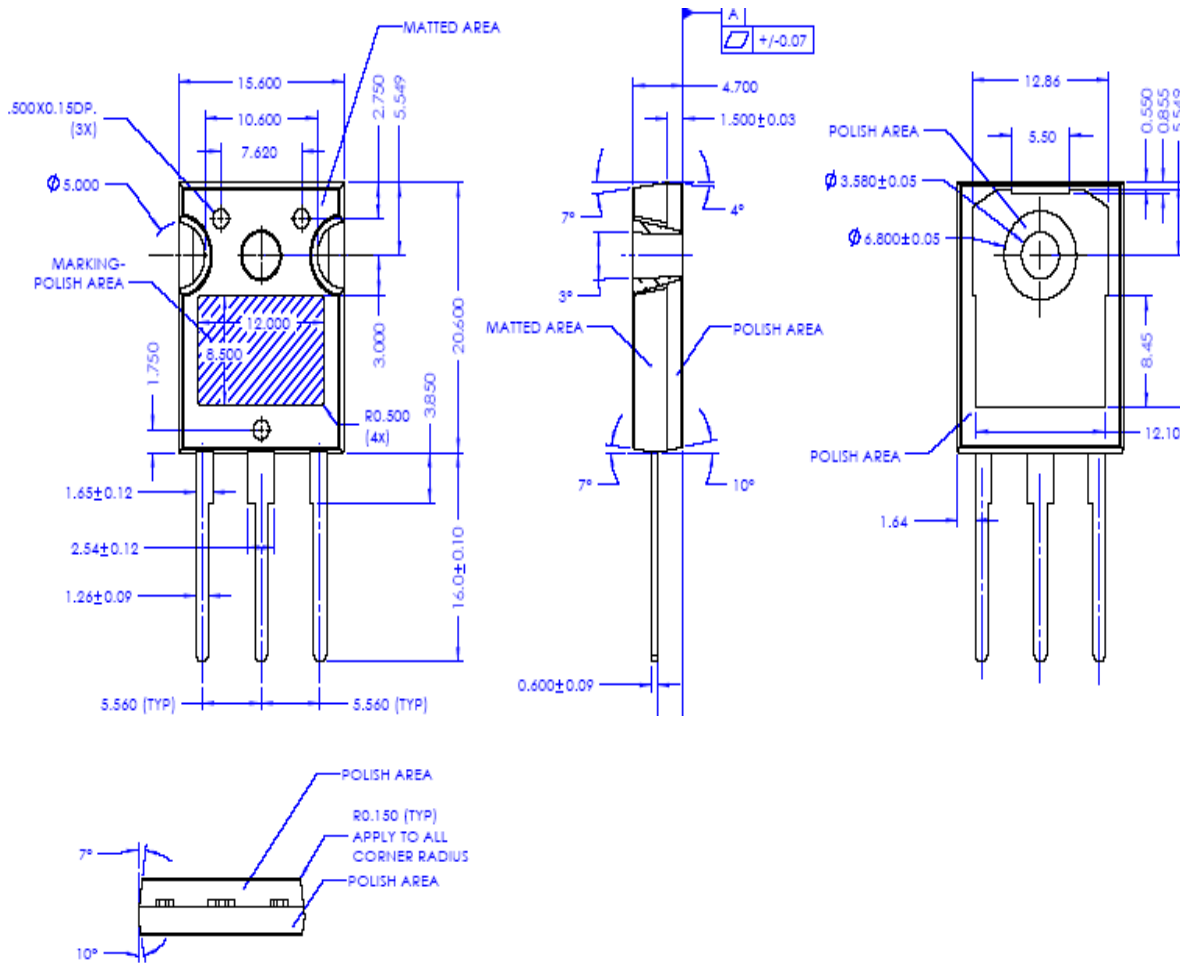

Figure 23. Transient Thermal Impedance of IGBT



Mechanical Dimensions

TO-247AB (FKS PKG CODE 001)









Dimensions in Millimeters



TRADEMARKS

The following includes registered and unregistered trademarks and service marks, owned by Fairchild Semiconductor and/or its global subsidiaries, and is not intended to be an exhaustive list of all such trademarks.

- | | | | |
|--|---|--|---|
| Auto-SPM™ | F-PFS™ | PowerTrench® | The Power Franchise® |
| Build it Now™ | FRFET® | PowerXS™ | the power franchise |
| CorePLUS™ | Global Power Resource SM | Programmable Active Droop™ | TinyBoost™ |
| CorePOWER™ | Green FPS™ | QFET® | TinyBuck™ |
| CROSSVOL™ | Green FPS™ e-Series™ | QS™ | TinyLogic® |
| CTL™ | Gmax™ | Quiet Series™ | TINYOPTO™ |
| Current Transfer Logic™ | GTO™ | RapidConfigure™ | TinyPower™ |
| EcoSPARK® | IntelliMAX™ |  ™ | TinyPWM™ |
| EfficientMax™ | ISOPANAR™ | Saving our world, 1mW/W/kW at a time™ | TinyWire™ |
| EZSWITCH™* | MegaBuck™ | SmartMax™ | TriFault Detect™ |
|  ™* | MICROCOUPLER™ | SMART START™ | TRUECURRENT™* |
|  ™ | MicroFET™ | SPM® | µSerDes™ |
| Fairchild® | MicroPak™ | STEALTH™ |  ™ |
| Fairchild Semiconductor® | MillerDrive™ | SuperFET™ | UHC® |
| FACT Quiet Series™ | MotionMax™ | SuperSOT™-3 | Ultra FRFET™ |
| FACT® | Motion-SPM™ | SuperSOT™-6 | UniFET™ |
| FAST® | OPTOLOGIC® | SuperSOT™-8 | VCX™ |
| FastvCore™ | OPTOPLANAR® | SupreMOS™ | VisualMax™ |
| FETBench™ |  ™ | SyncFET™ | XS™ |
| FlashWriter®* | PDP SPM™ | Sync-Lock™ | |
| FPS™ | Power-SPM™ |  ™* | |

* Trademarks of System General Corporation, used under license by Fairchild Semiconductor.

DISCLAIMER

FAIRCHILD SEMICONDUCTOR RESERVES THE RIGHT TO MAKE CHANGES WITHOUT FURTHER NOTICE TO ANY PRODUCTS HEREIN TO IMPROVE RELIABILITY, FUNCTION, OR DESIGN. FAIRCHILD DOES NOT ASSUME ANY LIABILITY ARISING OUT OF THE APPLICATION OR USE OF ANY PRODUCT OR CIRCUIT DESCRIBED HEREIN; NEITHER DOES IT CONVEY ANY LICENSE UNDER ITS PATENT RIGHTS, NOR THE RIGHTS OF OTHERS. THESE SPECIFICATIONS DO NOT EXPAND THE TERMS OF FAIRCHILD'S WORLDWIDE TERMS AND CONDITIONS, SPECIFICALLY THE WARRANTY THEREIN, WHICH COVERS THESE PRODUCTS.

LIFE SUPPORT POLICY

FAIRCHILD'S PRODUCTS ARE NOT AUTHORIZED FOR USE AS CRITICAL COMPONENTS IN LIFE SUPPORT DEVICES OR SYSTEMS WITHOUT THE EXPRESS WRITTEN APPROVAL OF FAIRCHILD SEMICONDUCTOR CORPORATION.

As used herein:

1. Life support devices or systems are devices or systems which, (a) are intended for surgical implant into the body or (b) support or sustain life, and (c) whose failure to perform when properly used in accordance with instructions for use provided in the labeling, can be reasonably expected to result in a significant injury of the user.
2. A critical component in any component of a life support, device, or system whose failure to perform can be reasonably expected to cause the failure of the life support device or system, or to affect its safety or effectiveness.

ANTI-COUNTERFEITING POLICY

Fairchild Semiconductor Corporation's Anti-Counterfeiting Policy. Fairchild's Anti-Counterfeiting Policy is also stated on our external website, www.fairchildsemi.com, under Sales Support.

Counterfeiting of semiconductor parts is a growing problem in the industry. All manufacturers of semiconductor products are experiencing counterfeiting of their parts. Customers who inadvertently purchase counterfeit parts experience many problems such as loss of brand reputation, substandard performance, failed applications, and increased cost of production and manufacturing delays. Fairchild is taking strong measures to protect ourselves and our customers from the proliferation of counterfeit parts. Fairchild strongly encourages customers to purchase Fairchild parts either directly from Fairchild or from Authorized Fairchild Distributors who are listed by country on our web page cited above. Products customers buy either from Fairchild directly or from Authorized Fairchild Distributors are genuine parts, have full traceability, meet Fairchild's quality standards for handling and storage and provide access to Fairchild's full range of up-to-date technical and product information. Fairchild and our Authorized Distributors will stand behind all warranties and will appropriately address any warranty issues that may arise. Fairchild will not provide any warranty coverage or other assistance for parts bought from Unauthorized Sources. Fairchild is committed to combat this global problem and encourage our customers to do their part in stopping this practice by buying direct or from authorized distributors.

PRODUCT STATUS DEFINITIONS

Definition of Terms

| Datasheet Identification | Product Status | Definition |
|--------------------------|-----------------------|---|
| Advance Information | Formative / In Design | Datasheet contains the design specifications for product development. Specifications may change in any manner without notice. |
| Preliminary | First Production | Datasheet contains preliminary data; supplementary data will be published at a later date. Fairchild Semiconductor reserves the right to make changes at any time without notice to improve design. |
| No Identification Needed | Full Production | Datasheet contains final specifications. Fairchild Semiconductor reserves the right to make changes at any time without notice to improve the design. |
| Obsolete | Not In Production | Datasheet contains specifications on a product that is discontinued by Fairchild Semiconductor. The datasheet is for reference information only. |