

FGL60N100BNTD

NPT-Trench IGBT

General Description

Trench insulated gate bipolar transistors (IGBTs) with NPT technology show outstanding performance in conduction and switching characteristics as well as enhanced avalanche ruggedness. These devices are well suited for Induction Heating (I-H) applications

Features

- High Speed Switching
- Low Saturation Voltage : $V_{CE(sat)} = 2.5\text{ V @ } I_C = 60\text{ A}$
- High Input Impedance
- Built-in Fast Recovery Diode

Application

Micro- Wave Oven, I-H Cooker, I-H Jar, Induction Heater, Home Appliance

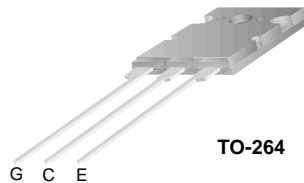

TO-264

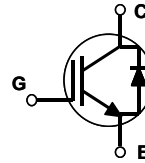

Absolute Maximum Ratings $T_C = 25^\circ\text{C}$ unless otherwise noted

Symbol	Description	FGL60N100BNTD	Units
V_{CES}	Collector-Emitter Voltage	1000	V
V_{GES}	Gate-Emitter Voltage	± 25	V
I_C	Collector Current @ $T_C = 25^\circ\text{C}$	60	A
	Collector Current @ $T_C = 100^\circ\text{C}$	42	A
$I_{CM(1)}$	Pulsed Collector Current	200	A
I_F	Diode Continuous Forward Current @ $T_C = 100^\circ\text{C}$	15	A
I_{FM}	Diode Maximum Forward Current	200	A
P_D	Maximum Power Dissipation @ $T_C = 25^\circ\text{C}$	180	W
	Maximum Power Dissipation @ $T_C = 100^\circ\text{C}$	72	W
T_J	Operating Junction Temperature	-55 to +150	$^\circ\text{C}$
T_{stg}	Storage Temperature Range	-55 to +150	$^\circ\text{C}$
T_L	Maximum Lead Temp. for soldering Purposes, 1/8" from case for 5 seconds	300	$^\circ\text{C}$

Notes :

(1) Repetitive rating : Pulse width limited by max. junction temperature

Thermal Characteristics

Symbol	Parameter	Typ.	Max.	Units
$R_{\theta JC}$ (IGBT)	Thermal Resistance, Junction-to-Case	--	0.69	$^\circ\text{C/W}$
$R_{\theta JC}$ (DIODE)	Thermal Resistance, Junction-to-Case	--	2.08	$^\circ\text{C/W}$
$R_{\theta JA}$	Thermal Resistance, Junction-to-Ambient	--	25	$^\circ\text{C/W}$

Electrical Characteristics of IGBT $T_C = 25^\circ\text{C}$ unless otherwise noted

Symbol	Parameter	Test Conditions	Min.	Typ.	Max.	Units
BV_{CES}	Collector Emitter Breakdown Voltage	$V_{GE} = 0V, I_C = 1mA$	1000	--	--	V
I_{CES}	Collector Cut-Off Current	$V_{CE} = 1000V, V_{GE} = 0V$	--	--	1.0	mA
I_{GES}	G-E Leakage Current	$V_{GE} = \pm 25, V_{CE} = 0V$	--	--	± 500	nA

On Characteristics

$V_{GE(th)}$	G-E Threshold Voltage	$I_C = 60mA, V_{CE} = V_{GE}$	4.0	5.0	7.0	V
$V_{CE(sat)}$	Collector to Emitter Saturation Voltage	$I_C = 10A, V_{GE} = 15V$	--	1.5	1.8	V
		$I_C = 60A, V_{GE} = 15V$	--	2.5	2.9	V

Dynamic Characteristics

C_{ies}	Input Capacitance	$V_{CE}=10V, V_{GE} = 0V,$ $f = 1MHz$	--	6000	--	pF
C_{oes}	Output Capacitance		--	260	--	pF
C_{res}	Reverse Transfer Capacitance		--	200	--	pF

Switching Characteristics

$t_{d(on)}$	Turn-On Delay Time	$V_{CC} = 600V, I_C = 60A,$ $R_G = 51\Omega, V_{GE}=15V,$ Resistive Load, $T_C = 25^\circ\text{C}$	--	140	--	ns
t_r	Rise Time		--	320	--	ns
$t_{d(off)}$	Turn-Off Delay Time		--	630	--	ns
t_f	Fall Time		--	130	250	ns
Q_g	Total Gate Charge	$V_{CE} = 600V, I_C = 60A,$ $V_{GE} = 15V, T_C = 25^\circ\text{C}$	--	275	350	nC
Q_{ge}	Gate-Emitter Charge		--	45	--	nC
Q_{gc}	Gate-Collector Charge		--	95	--	nC

Electrical Characteristics of DIODE $T_C = 25^\circ\text{C}$ unless otherwise noted

Symbol	Parameter	Test Conditions	Min.	Typ.	Max.	Units
V_{FM}	Diode Forward Voltage	$I_F = 15A$	--	1.2	1.7	V
		$I_F = 60A$	--	1.8	2.1	V
t_{rr}	Diode Reverse Recovery Time	$I_F = 60A, di/dt = 20 A/us$	--	1.2	1.5	μs
I_R	Instantaneous Reverse Current	$V_{RRM} = 1000V$	--	0.05	2	μA

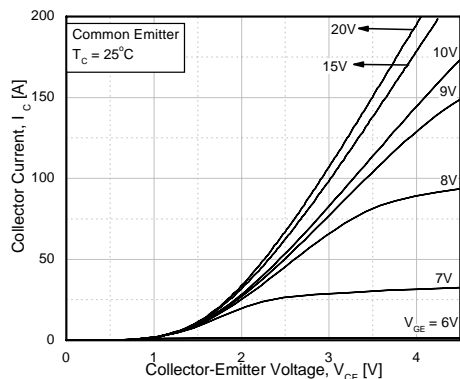

Fig 1. Typical Output Characteristics

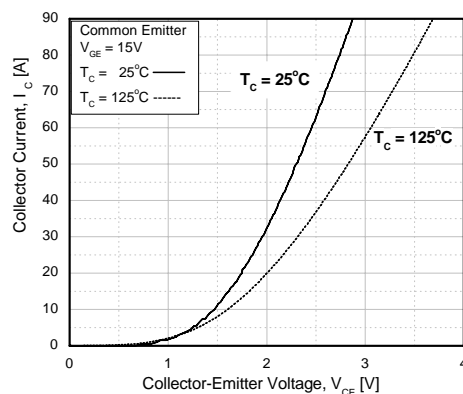

Fig 2. Typical Saturation Voltage Characteristics

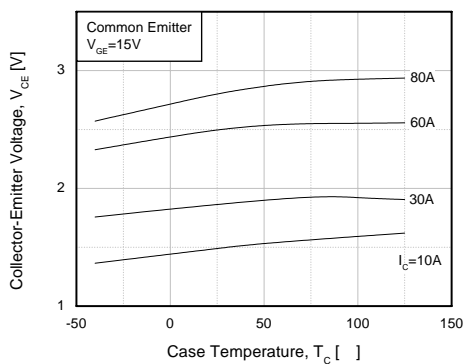

Fig 3. Saturation Voltage vs. Case Temperature at Variant Current Level

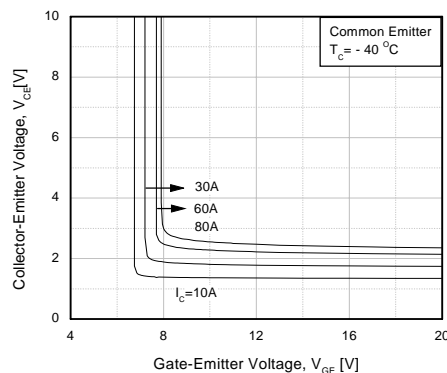

Fig 4. Saturation Voltage vs. V_{GE}

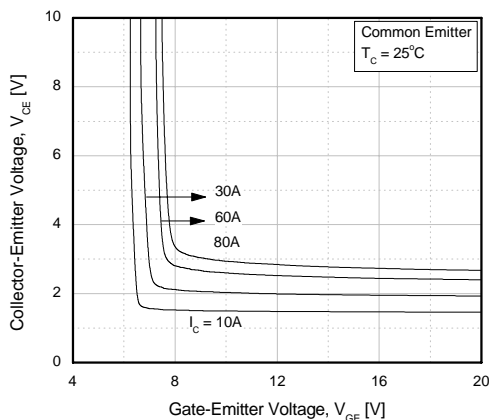

Fig 5. Saturation Voltage vs. V_{GE}

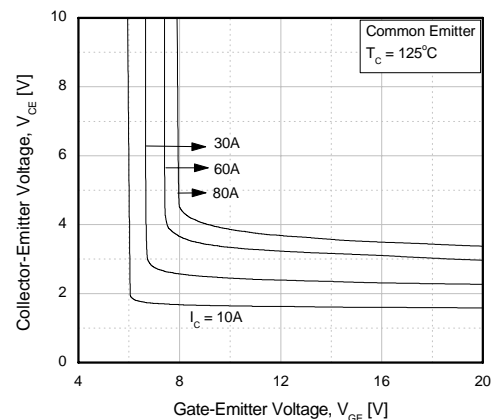

Fig 6. Saturation Voltage vs. V_{GE}

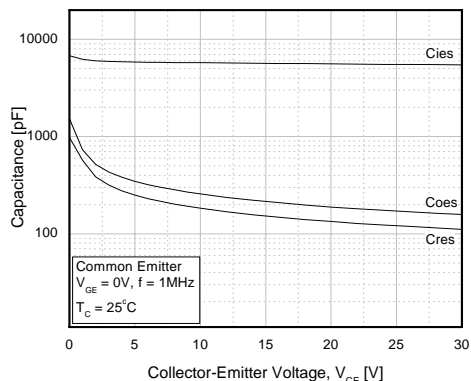

Fig 7. Capacitance Characteristics

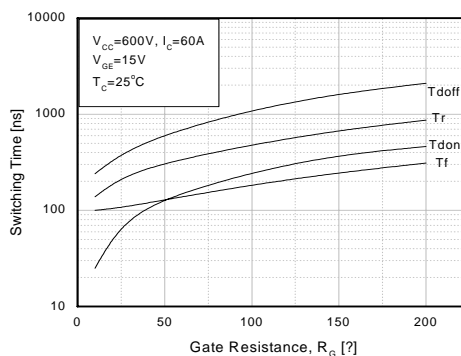

Fig 8. Switching Characteristics vs. Gate Resistance

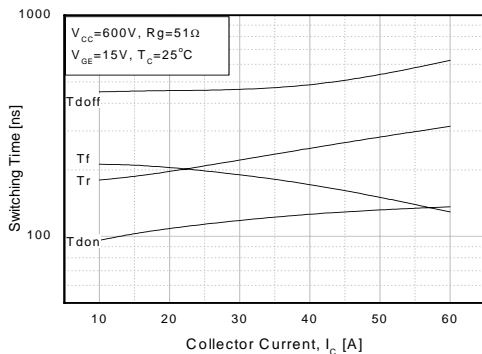

Fig 9. Switching Characteristics vs. Collector Current

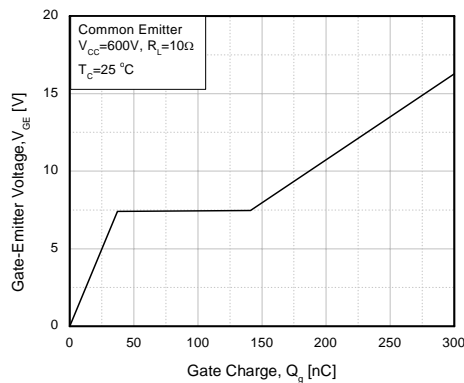

Fig 10. Gate Charge Characteristics

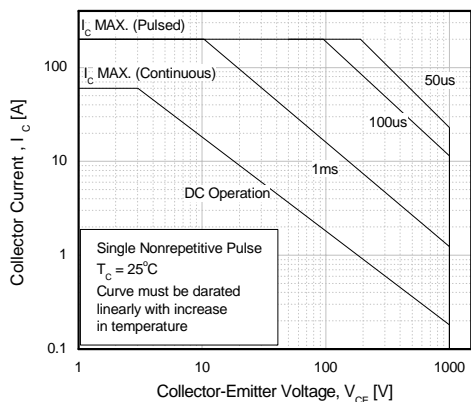

Fig 11. SOA Characteristics

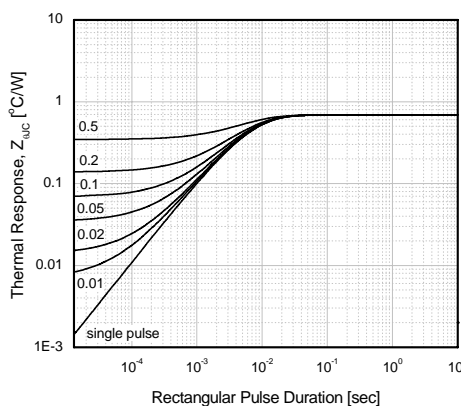

Fig 12. Transient Thermal Impedance of IGBT

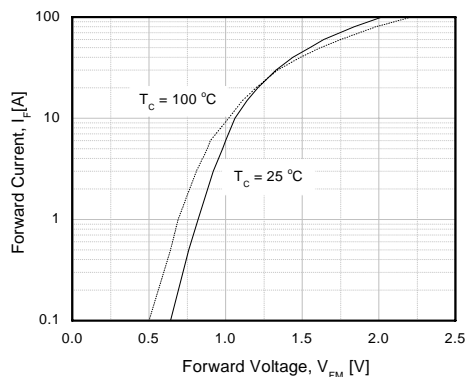

Fig 13. Forward Characteristics

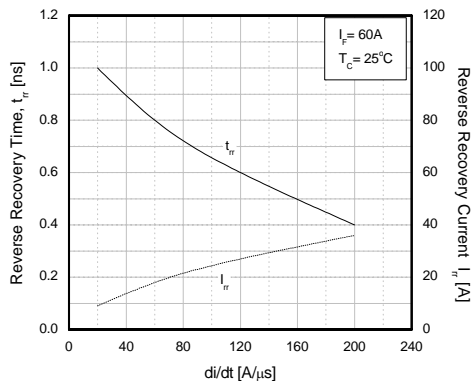

Fig 14. Reverse Recovery Characteristics vs. di/dt

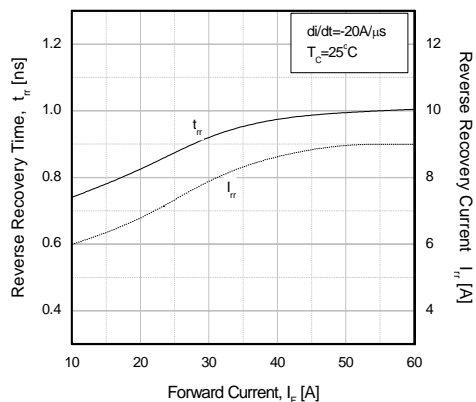

Fig 15. Reverse Recovery Characteristics vs. Forward Current

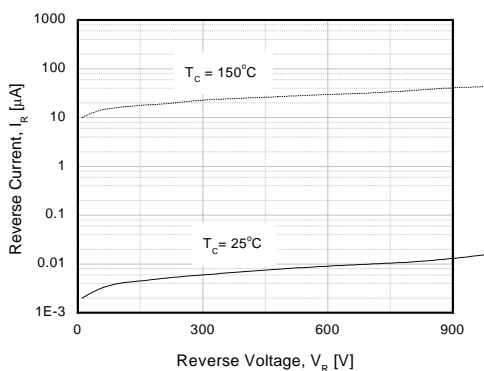

Fig 16. Reverse Current vs. Reverse Voltage

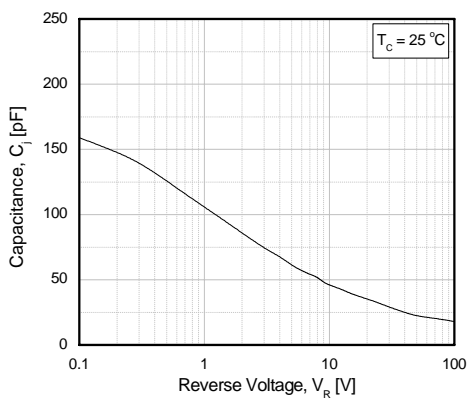
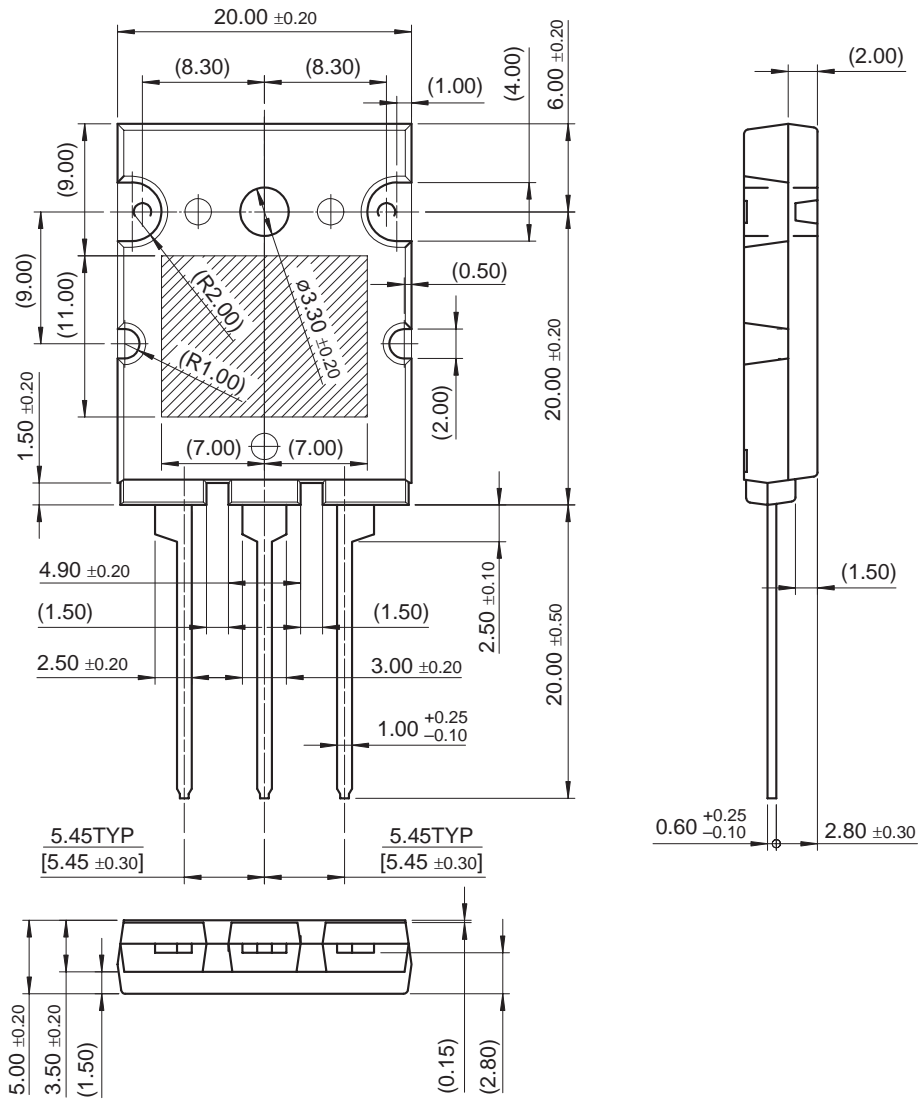

Fig 17. Junction capacitance

Package Dimension

TO-264

FGL60N100BNTD



Dimensions in Millimeters



TRADEMARKS

The following are registered and unregistered trademarks and service marks Fairchild Semiconductor owns or is authorized to use and is not intended to be an exhaustive list of all such trademarks.

ACE [®]	Green FPST [™] e-Series [™]	POWEREDGE [®]	SuperSOT [™] -8
Build it Now [™]	GOT [™]	Power-SPM [™]	SyncFET [™]
CorePLUS [™]	<i>i-Lo</i> [™]	PowerTrench [®]	The Power Franchise [®]
CROSSVOLT [™]	IntelliMAX [™]	Programmable Active Droop [™]	 ™
CTL [™]	ISOPLANAR [™]	QFET [®]	TinyBoost [™]
Current Transfer Logic [™]	MegaBuck [™]	QST [™]	TinyBuck [™]
EcoSPARK [®]	MICROCOUPLER [™]	QT Optoelectronics [™]	TinyLogic [®]
FACT Quiet Series [™]	MicroFET [™]	Quiet Series [™]	TINYOPTO [™]
FACT [®]	MicroPak [™]	RapidConfigure [™]	TinyPower [™]
FAST [®]	Motion-SPM [™]	SMART START [™]	TinyPWM [™]
FastvCore [™]	OPTOLOGIC [®]	SPM [®]	TinyWire [™]
FPS [™]	OPTOPLANAR [®]	STEALTH [™]	μSerDes [™]
FRFET [®]	PDP-SPM [™]	SuperFET [™]	UHC [®]
Global Power Resource SM	Power220 [®]	SuperSOT [™] -3	UniFET [™]
Green FPS [™]	Power247 [®]	SuperSOT [™] -6	VCX [™]

DISCLAIMER

FAIRCHILD SEMICONDUCTOR RESERVES THE RIGHT TO MAKE CHANGES WITHOUT FURTHER NOTICE TO ANY PRODUCTS HEREIN TO IMPROVE RELIABILITY, FUNCTION, OR DESIGN. FAIRCHILD DOES NOT ASSUME ANY LIABILITY ARISING OUT OF THE APPLICATION OR USE OF ANY PRODUCT OR CIRCUIT DESCRIBED HEREIN; NEITHER DOES IT CONVEY ANY LICENSE UNDER ITS PATENT RIGHTS, NOR THE RIGHTS OF OTHERS. THESE SPECIFICATIONS DO NOT EXPAND THE TERMS OF FAIRCHILD'S WORLDWIDE TERMS AND CONDITIONS, SPECIFICALLY THE WARRANTY THEREIN, WHICH COVERS THESE PRODUCTS.

LIFE SUPPORT POLICY

FAIRCHILD'S PRODUCTS ARE NOT AUTHORIZED FOR USE AS CRITICAL COMPONENTS IN LIFE SUPPORT DEVICES OR SYSTEMS WITHOUT THE EXPRESS WRITTEN APPROVAL OF FAIRCHILD SEMICONDUCTOR CORPORATION.

As used herein:

1. Life support devices or systems are devices or systems which, (a) are intended for surgical implant into the body or (b) support or sustain life, and (c) whose failure to perform when properly used in accordance with instructions for use provided in the labeling, can be reasonably expected to result in a significant injury of the user.
2. A critical component in any component of a life support, device, or system whose failure to perform can be reasonably expected to cause the failure of the life support device or system, or to affect its safety or effectiveness.

PRODUCT STATUS DEFINITIONS

Definition of Terms

Datasheet Identification	Product Status	Definition
Advance Information	Formative or In Design	This datasheet contains the design specifications for product development. Specifications may change in any manner without notice.
Preliminary	First Production	This datasheet contains preliminary data; supplementary data will be published at a later date. Fairchild Semiconductor reserves the right to make changes at any time without notice to improve design.
No Identification Needed	Full Production	This datasheet contains final specifications. Fairchild Semiconductor reserves the right to make changes at any time without notice to improve design.
Obsolete	Not In Production	This datasheet contains specifications on a product that has been discontinued by Fairchild Semiconductor. The datasheet is printed for reference information only.

Rev. I29