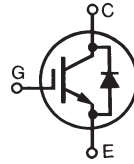
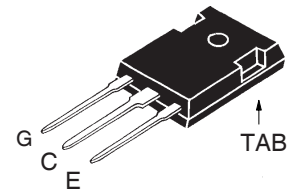

**GenX3™ 1200V IGBT**
**IXGH30N120C3H1**
**High speed PT IGBTs for  
10-50kHz Switching**

$$\begin{aligned}
 V_{CES} &= 1200V \\
 I_{C100} &= 24A \\
 V_{CE(sat)} &\leq 4.2V \\
 t_{fi(typ)} &= 42ns
 \end{aligned}$$

Symbol	Test Conditions	Maximum Ratings	
$V_{CES}$	$T_J = 25^\circ\text{C}$ to $150^\circ\text{C}$	1200	V
$V_{CGR}$	$T_J = 25^\circ\text{C}$ to $150^\circ\text{C}$ , $R_{GE} = 1M\Omega$	1200	V
$V_{GES}$	Continuous	$\pm 20$	V
$V_{GEM}$	Transient	$\pm 30$	V
$I_{C25}$	$T_C = 25^\circ\text{C}$	48	A
$I_{C100}$	$T_C = 100^\circ\text{C}$	24	A
$I_{CM}$	$T_C = 25^\circ\text{C}$ , 1ms	115	A
$I_A$	$T_C = 25^\circ\text{C}$	20	A
$E_{AS}$	$T_C = 25^\circ\text{C}$	250	mJ
<b>SSOA</b> <b>(RBSOA)</b>	$V_{GE} = 15V$ , $T_J = 125^\circ\text{C}$ , $R_G = 5\Omega$ Clamped Inductive Load	$I_{CM} = 60$ @ $V_{CE} \leq 1200$	A V
$P_C$	$T_C = 25^\circ\text{C}$	250	W
$T_J$		-55 ... +150	$^\circ\text{C}$
$T_{JM}$		150	$^\circ\text{C}$
$T_{stg}$		-55 ... +150	$^\circ\text{C}$
$M_d$	Mounting Torque	1.13/10	Nm/lb.in.
$T_L$	Maximum Lead Temperature for Soldering	300	$^\circ\text{C}$
$T_{SOLD}$	1.6mm (0.062 in.) from Case for 10s	260	$^\circ\text{C}$
<b>Weight</b>		6	g

**TO-247AD**

G = Gate      C = Collector  
E = Emitter    TAB = Collector

**Features**

- Optimized for Low Conduction and Switching Losses
- Square RBSOA
- Anti-Parallel Ultra Fast Diode
- Avalanche Rated
- International Standard Package

**Advantages**

- High Power Density
- Low Gate Drive Requirement

**Applications**

- AC Motor Speed Control
- DC Servo and Robot Drives
- DC Choppers
- Uninterruptible Power Supplies (UPS)
- Switch-Mode and Resonant-Mode Power Supplies

Symbol	Test Conditions ( $T_J = 25^\circ\text{C}$ , Unless Otherwise Specified)	Characteristic Values		
		Min.	Typ.	Max.
$BV_{CES}$	$I_C = 250\mu\text{A}$ , $V_{GE} = 0V$	1200		V
$V_{GE(th)}$	$I_C = 250\mu\text{A}$ , $V_{CE} = V_{GE}$	3.0		5.0 V
$I_{CES}$	$V_{CE} = V_{CES}$ , $V_{GE} = 0V$ $T_J = 125^\circ\text{C}$			100 $\mu\text{A}$ 1.5 mA
$I_{GES}$	$V_{CE} = 0V$ , $V_{GE} = \pm 20V$			$\pm 100$ nA
$V_{CE(sat)}$	$I_C = 24A$ , $V_{GE} = 15V$ , Note 2 $T_J = 125^\circ\text{C}$		3.6 3.2	4.2 V V

Symbol	Test Conditions ( $T_J = 25^\circ\text{C}$ , Unless Otherwise Specified)	Characteristic Values		
		Min.	Typ.	Max.
$g_{fs}$	$I_C = 24\text{A}, V_{CE} = 10\text{V}$ , Note 2	10	17	S
$C_{ies}$ $C_{oes}$ $C_{res}$	$V_{CE} = 25\text{V}, V_{GE} = 0\text{V}, f = 1\text{MHz}$		1810	pF
			185	pF
			50	pF
$Q_g$ $Q_{ge}$ $Q_{gc}$	$I_C = 24\text{A}, V_{GE} = 15\text{V}, V_{CE} = 0.5 \cdot V_{CES}$		80	nC
			11	nC
			37	nC
$t_{d(on)}$ $t_{ri}$ $E_{on}$ $t_{d(off)}$ $t_{fi}$ $E_{off}$	<b>Inductive Load, <math>T_J = 25^\circ\text{C}</math></b> $I_C = 24\text{A}, V_{GE} = 15\text{V}$ $V_{CE} = 600\text{V}, R_G = 5\Omega$ Note 1		18	ns
			33	ns
			1.45	mJ
			106	ns
			42	ns
			0.47	0.85 mJ
$t_{d(on)}$ $t_{ri}$ $E_{on}$ $t_{d(off)}$ $t_{fi}$ $E_{off}$	<b>Inductive Load, <math>T_J = 125^\circ\text{C}</math></b> $I_C = 24\text{A}, V_{GE} = 15\text{V}$ $V_{CE} = 600\text{V}, R_G = 5\Omega$ Note 1		20	ns
			40	ns
			2.50	mJ
			135	ns
			280	ns
			1.30	2.10 mJ
$R_{thJC}$ $R_{thCK}$				0.50 $^\circ\text{C}/\text{W}$ $^\circ\text{C}/\text{W}$

### TO-247 (IXGH) AD Outline

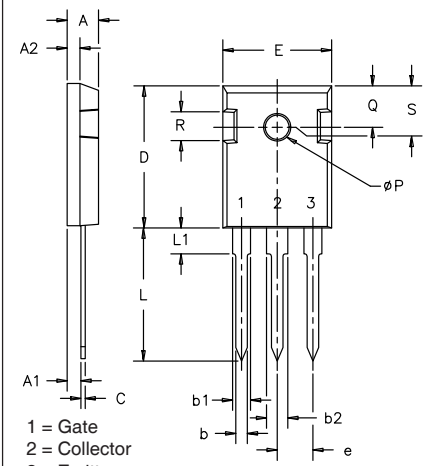

SYM	INCHES		MILLIMETERS	
	MIN	MAX	MIN	MAX
A	.185	.209	4.7	5.3
A1	.087	.102	2.2	2.54
A2	.059	.098	2.2	2.6
b	.040	.055	1.0	1.4
b1	.065	.084	1.65	2.13
b2	.113	.123	2.87	3.12
C	.016	.031	.4	.8
D	.819	.845	20.80	21.46
E	.610	.640	15.75	16.26
e	.215 BSC		5.45 BSC	
L	.780	.800	19.81	20.32
L1		.177		4.50
$\phi P$	.140	.144	3.55	3.65
Q	.212	.244	5.4	6.2
R	.170	.216	4.32	5.49
S	.242 BSC		6.15 BSC	

### Reverse Diode (FRED)

Symbol	Test Conditions ( $T_J = 25^\circ\text{C}$ , Unless Otherwise Specified)	Characteristic Values		
		Min.	Typ.	Max.
$V_F$	$I_F = 20\text{A}, V_{GE} = 0\text{V}$ $T_J = 125^\circ\text{C}$			3.0 V 2.8 V
$I_{RM}$ $t_{rr}$	$I_F = 20\text{A}, -di_F/dt = 750\text{A}/\mu\text{s}, V_R = 800\text{V}$ $V_{GE} = 0\text{V}$		19	A
			70	ns
$R_{thJC}$				0.9 $^\circ\text{C}/\text{W}$

- Notes:
- Switching Times May Increase for  $V_{CE}$  (Clamp)  $> 0.5 \cdot V_{CES}$ , Higher  $T_J$  or Increased  $R_G$ .
  - Pulse Test,  $t \leq 300\mu\text{s}$ ; Duty Cycle,  $d \leq 2\%$ .

### PRELIMINARY TECHNICAL INFORMATION

The product presented herein is under development. The Technical Specifications offered are derived from data gathered during objective characterizations of preliminary engineering lots; but also may yet contain some information supplied during a pre-production design evaluation. IXYS reserves the right to change limits, test conditions, and dimensions without notice.

IXYS reserves the right to change limits, test conditions, and dimensions.

IXYS MOSFETs and IGBTs are covered by one or more of the following U.S. patents:	4,835,592	4,931,844	5,049,961	5,237,481	6,162,665	6,404,065 B1	6,683,344	6,727,585	7,005,734 B2	7,157,338B2
	4,850,072	5,017,508	5,063,307	5,381,025	6,259,123 B1	6,534,343	6,710,405 B2	6,759,692	7,063,975 B2	
	4,881,106	5,034,796	5,187,117	5,486,715	6,306,728 B1	6,583,505	6,710,463	6,771,478 B2	7,071,537	

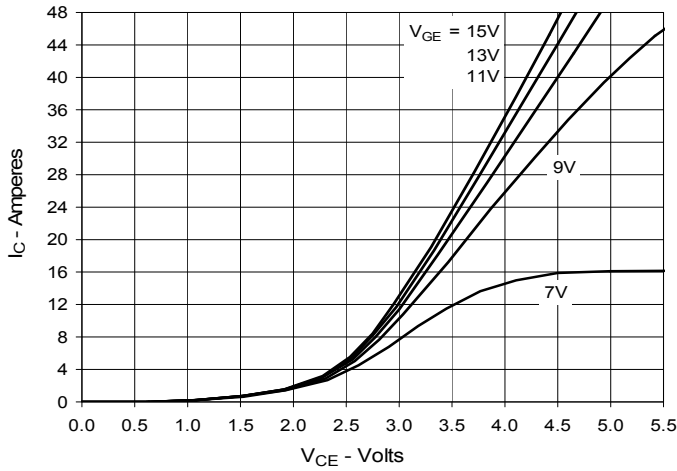
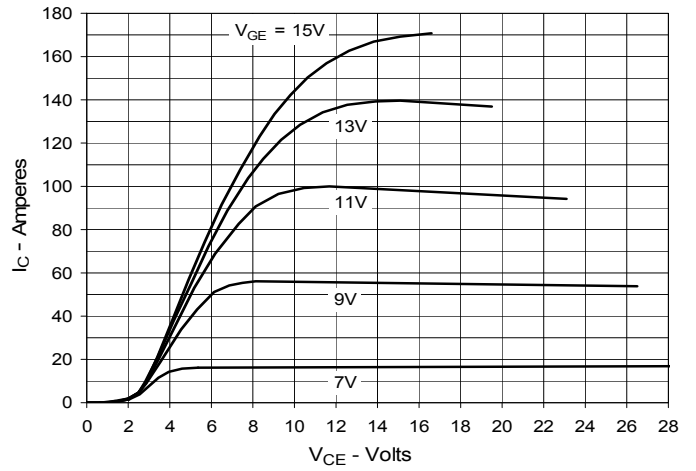
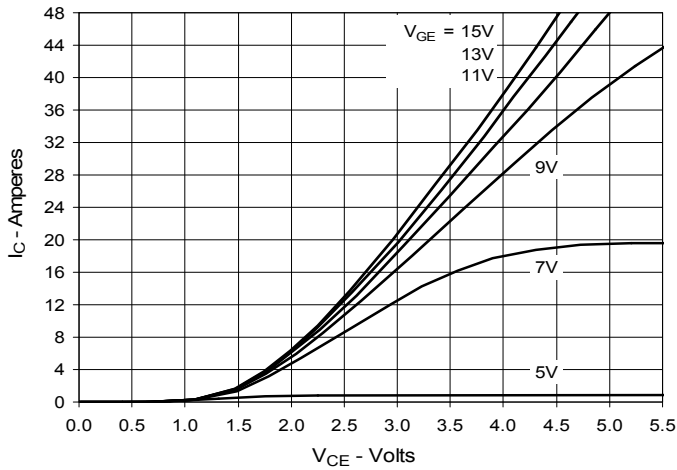
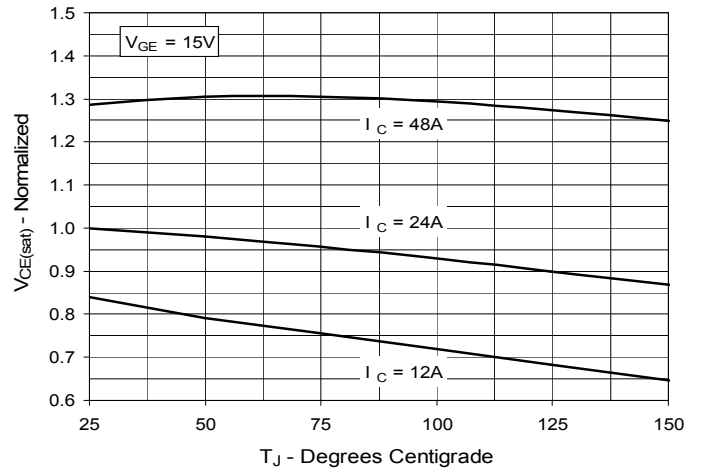
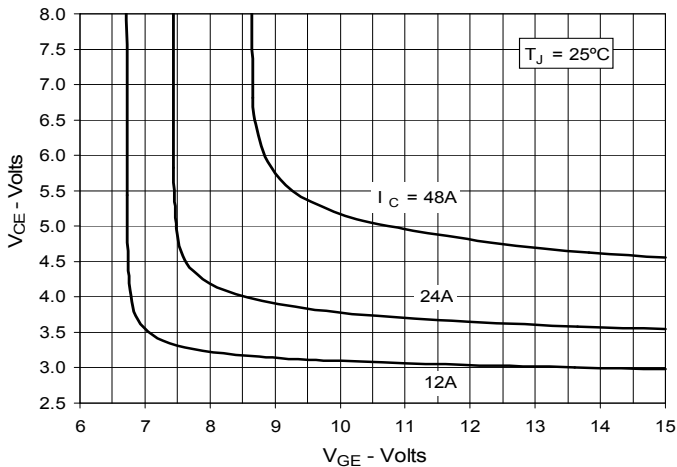
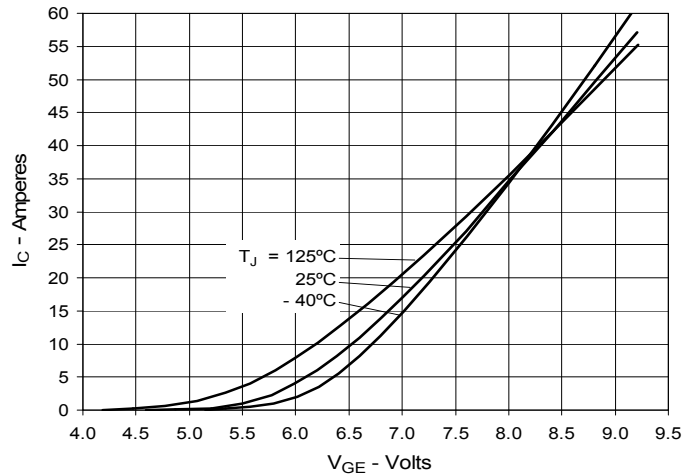
**Fig. 1. Output Characteristics @ 25°C**

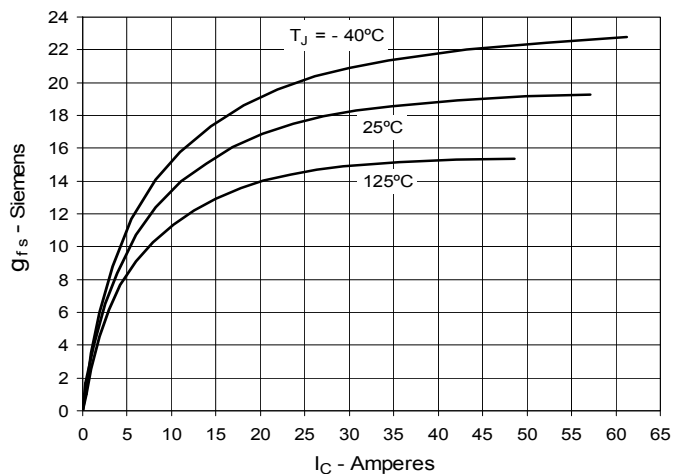
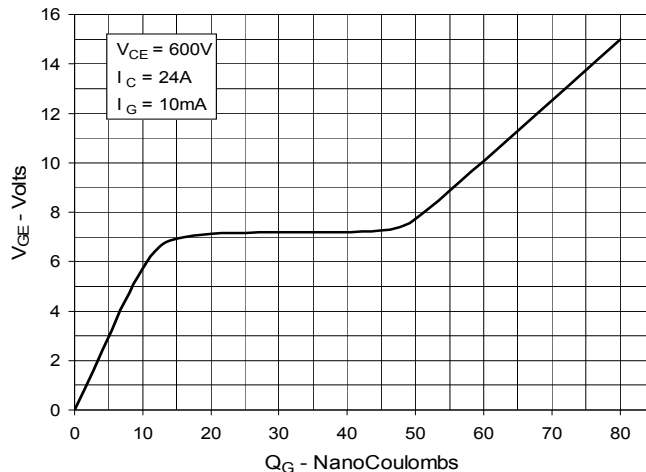
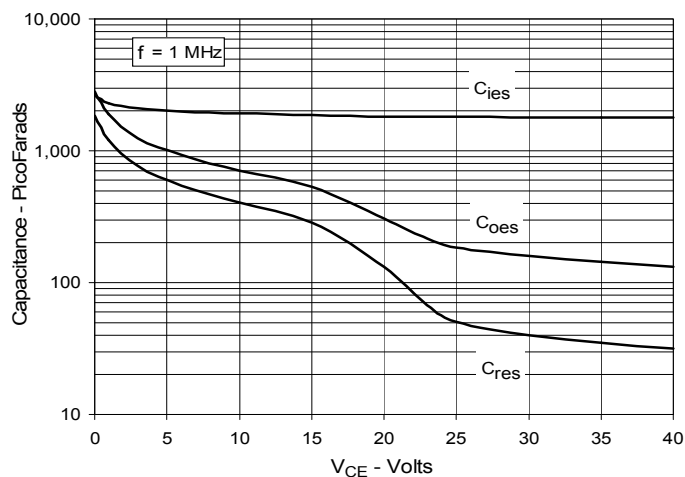
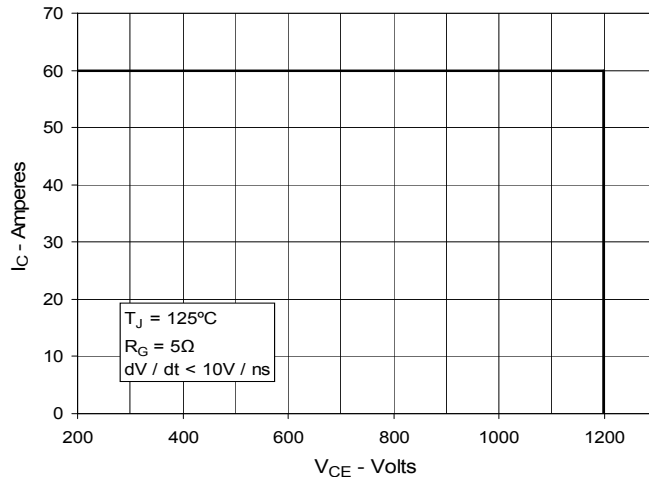
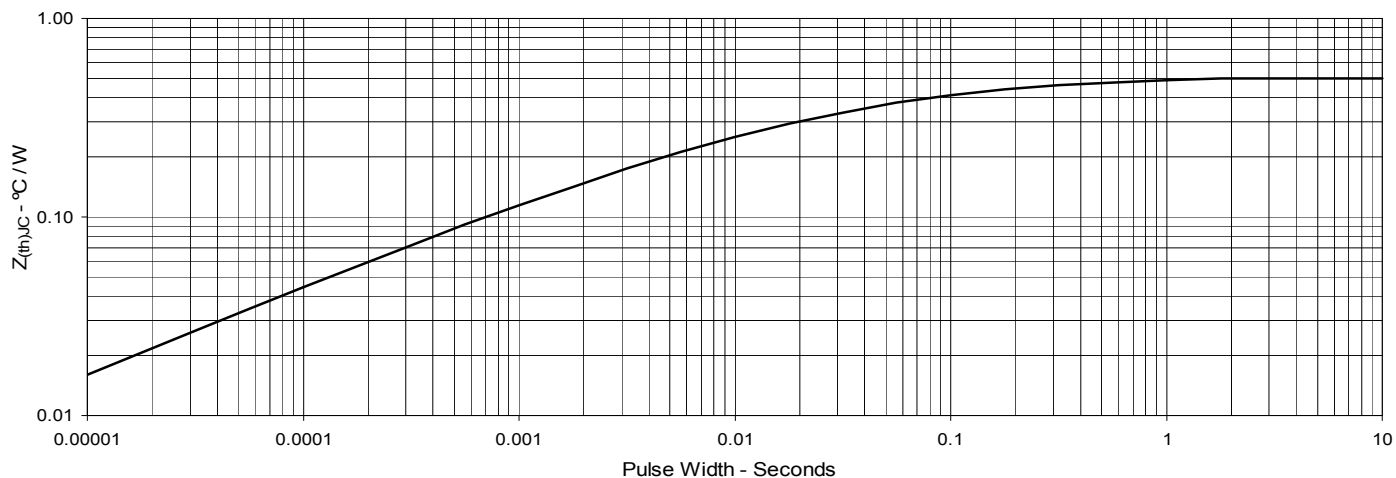
**Fig. 2. Extended Output Characteristics @ 25°C**

**Fig. 3. Output Characteristics @ 125°C**

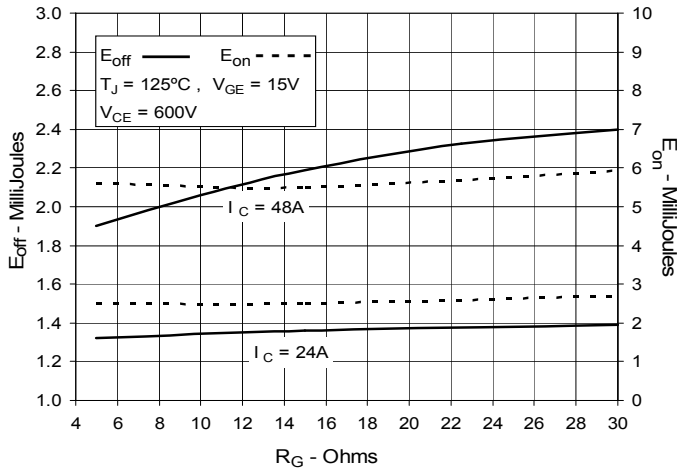
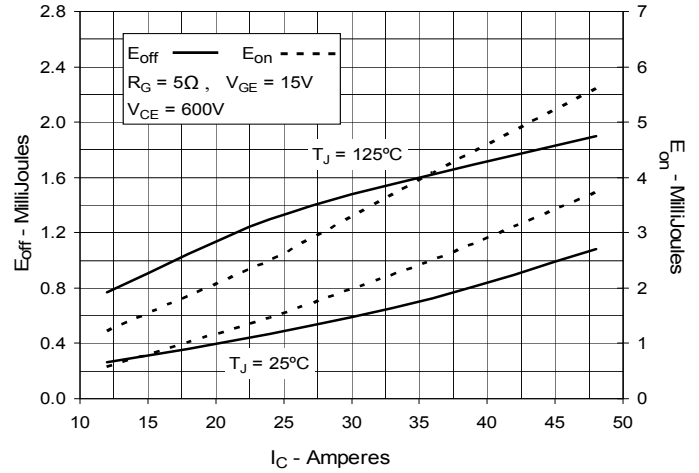
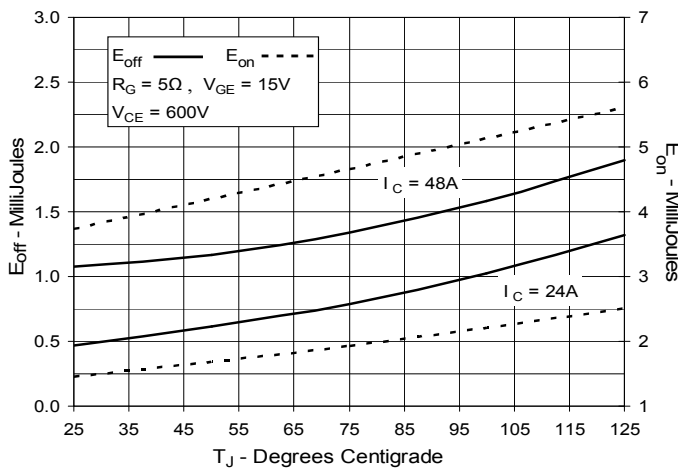
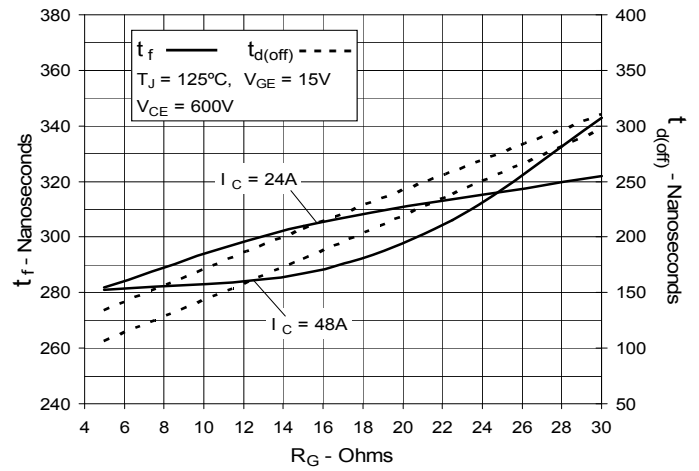
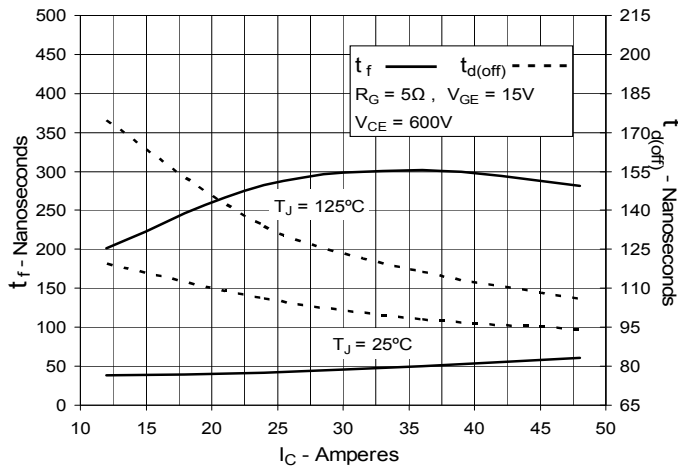
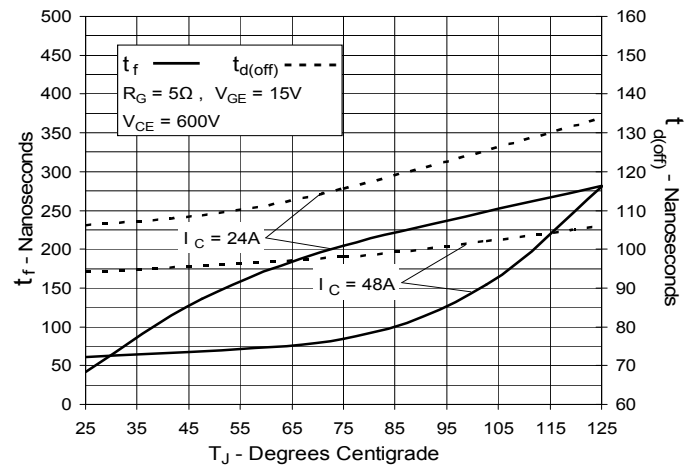
**Fig. 4. Dependence of  $V_{CE(sat)}$  on Junction Temperature**

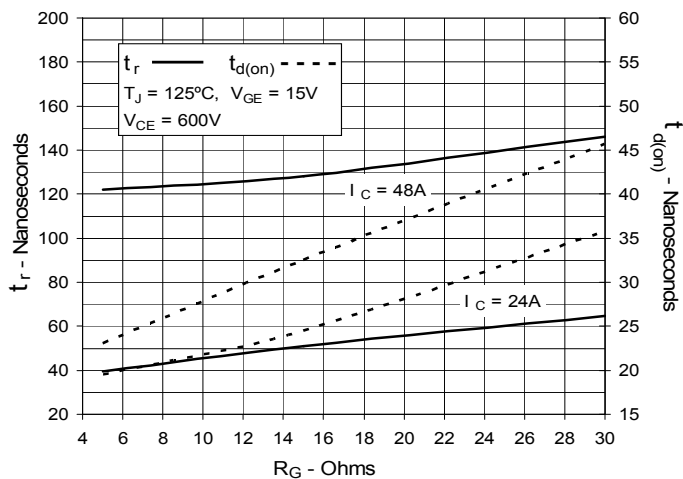
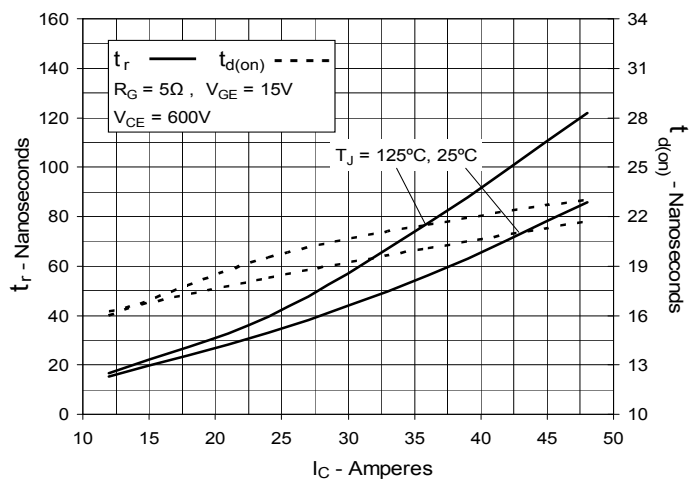
**Fig. 5. Collector-to-Emitter Voltage vs. Gate-to-Emitter Voltage**

**Fig. 6. Input Admittance**

**Fig. 7. Transconductance**

**Fig. 8. Gate Charge**

**Fig. 9. Capacitance**

**Fig. 10. Reverse-Bias Safe Operating Area**

**Fig. 11. Maximum Transient Thermal Impedance**

IXYS reserves the right to change limits, test conditions, and dimensions.

**Fig. 12. Inductive Switching Energy Loss vs. Gate Resistance**

**Fig. 13. Inductive Switching Energy Loss vs. Collector Current**

**Fig. 14. Inductive Switching Energy Loss vs. Junction Temperature**

**Fig. 15. Inductive Turn-off Switching Times vs. Gate Resistance**

**Fig. 16. Inductive Turn-off Switching Times vs. Collector Current**

**Fig. 17. Inductive Turn-off Switching Times vs. Junction Temperature**

**Fig. 18. Inductive Turn-on  
Switching Times vs. Gate Resistance**

**Fig. 19. Inductive Turn-on  
Switching Times vs. Collector Current**

**Fig. 20. Inductive Turn-on  
Switching Times vs. Junction Temperature**
