

# IRG4IBC30KDPbF

INSULATED GATE BIPOLAR TRANSISTOR WITH  
ULTRAFAST SOFT RECOVERY DIODE

Short Circuit Rated  
UltraFast IGBT

### Features

- High switching speed optimized for up to 25kHz with low  $V_{CE(on)}$
- Short Circuit Rating 10 $\mu$ s @ 125°C,  $V_{GE} = 15V$
- Generation 4 IGBT design provides tighter parameter distribution and higher efficiency than previous generation
- IGBT co-packaged with HEXFRED™ ultrafast, ultra-soft-recovery anti-parallel diodes for use in bridge configurations
- Industry standard TO-220 FULLPAK
- Lead-Free

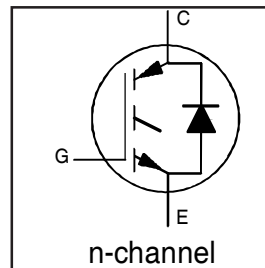

$V_{CES} = 600V$
$V_{CE(on)} \text{ typ.} = 2.21V$
@ $V_{GE} = 15V, I_C = 9.2A$

### Benefits

- Generation 4 IGBTs offer highest efficiencies available maximizing the power density of the system
- IGBT's optimized for specific application conditions
- HEXFRED™ diodes optimized for performance with IGBTs. Minimized recovery characteristics reduce noise EMI
- Designed to exceed the power handling capability of equivalent industry-standard IGBT

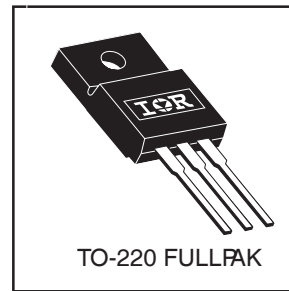

### Absolute Maximum Ratings

	Parameter	Max.	Units
$V_{CES}$	Collector-to-Emitter Voltage	600	V
$I_C @ T_C = 25^\circ C$	Continuous Collector Current	17	A
$I_C @ T_C = 100^\circ C$	Continuous Collector Current	9.2	
$I_{CM}$	Pulsed Collector Current ①⑤	34	
$I_{LM}$	Clamped Inductive Load Current ②③	34	
$I_F @ T_C = 100^\circ C$	Diode Continuous Forward Current	9.2	
$I_{FM}$	Diode Maximum Forward Current	34	
$t_{sc}$	Short Circuit Withstand Time	10	$\mu$ s
$V_{ISOL}$	RMS Isolation Voltage, Terminal to Case, $t = 1 \text{ min}$	2500	V
$V_{GE}$	Gate-to-Emitter Voltage	$\pm 20$	W
$P_D @ T_C = 25^\circ C$	Maximum Power Dissipation	45	
$P_D @ T_C = 100^\circ C$	Maximum Power Dissipation	18	
$T_J$	Operating Junction and	-55 to +150	$^\circ C$
$T_{STG}$	Storage Temperature Range		
	Soldering Temperature, for 10 sec.		
	Mounting Torque, 6-32 or M3 Screw.	10 lbf•in (1.1 N•m)	

### Thermal Resistance

	Parameter	Typ.	Max.	Units
$R_{\theta JC}$	Junction-to-Case - IGBT	---	2.8	$^\circ C/W$
$R_{\theta CS}$	Junction-to-Case - Diode	---	3.7	
$R_{\theta JA}$	Junction-to-Ambient, typical socket mount	---	65	
Wt	Weight	2.0 (0.07)	---	g (oz)

# IRG4IBC30KDPbF

International  
IR Rectifier

## Electrical Characteristics @ T<sub>J</sub> = 25°C (unless otherwise specified)

	Parameter	Min.	Typ.	Max.	Units	Conditions
V <sub>(BR)CES</sub>	Collector-to-Emitter Breakdown Voltage <sup>③</sup>	600	—	—	V	V <sub>GE</sub> = 0V, I <sub>C</sub> = 250μA
ΔV <sub>(BR)CES</sub> /ΔT <sub>J</sub>	Temperature Coeff. of Breakdown Voltage	—	0.54	—	V/°C	V <sub>GE</sub> = 0V, I <sub>C</sub> = 1.0mA
V <sub>CE(on)</sub>	Collector-to-Emitter Saturation Voltage	—	2.21	2.7	V	I <sub>C</sub> = 16A V <sub>GE</sub> = 15V
		—	2.88	—		I <sub>C</sub> = 28A See Fig. 2, 5
		—	2.36	—		I <sub>C</sub> = 16A, T <sub>J</sub> = 150°C
V <sub>GE(th)</sub>	Gate Threshold Voltage	3.0	—	6.0		V <sub>CE</sub> = V <sub>GE</sub> , I <sub>C</sub> = 250μA
ΔV <sub>GE(th)</sub> /ΔT <sub>J</sub>	Temperature Coeff. of Threshold Voltage	—	-12	—	mV/°C	V <sub>CE</sub> = V <sub>GE</sub> , I <sub>C</sub> = 250μA
g <sub>fe</sub>	Forward Transconductance <sup>④</sup>	5.4	8.1	—	S	V <sub>CE</sub> = 100V, I <sub>C</sub> = 16A
I <sub>CES</sub>	Zero Gate Voltage Collector Current	—	—	250	μA	V <sub>GE</sub> = 0V, V <sub>CE</sub> = 600V
		—	—	2500		V <sub>GE</sub> = 0V, V <sub>CE</sub> = 600V, T <sub>J</sub> = 150°C
V <sub>FM</sub>	Diode Forward Voltage Drop	—	1.4	1.7	V	I <sub>C</sub> = 12A See Fig. 13
		—	1.3	1.6		I <sub>C</sub> = 12A, T <sub>J</sub> = 150°C
I <sub>GES</sub>	Gate-to-Emitter Leakage Current	—	—	±100	nA	V <sub>GE</sub> = ±20V

## Switching Characteristics @ T<sub>J</sub> = 25°C (unless otherwise specified)

	Parameter	Min.	Typ.	Max.	Units	Conditions
Q <sub>g</sub>	Total Gate Charge (turn-on)	—	67	100	nC	I <sub>C</sub> = 16A V <sub>CC</sub> = 400V See Fig.8 V <sub>GE</sub> = 15V
Q <sub>ge</sub>	Gate - Emitter Charge (turn-on)	—	11	16		
Q <sub>gc</sub>	Gate - Collector Charge (turn-on)	—	25	37		
t <sub>d(on)</sub>	Turn-On Delay Time	—	60	—	ns	T <sub>J</sub> = 25°C I <sub>C</sub> = 16A, V <sub>CC</sub> = 480V V <sub>GE</sub> = 15V, R <sub>G</sub> = 23Ω
t <sub>r</sub>	Rise Time	—	42	—		
t <sub>d(off)</sub>	Turn-Off Delay Time	—	160	250		
t <sub>f</sub>	Fall Time	—	80	120		
E <sub>on</sub>	Turn-On Switching Loss	—	0.60	—	mJ	Energy losses include "tail" and diode reverse recovery See Fig. 9,10,14
E <sub>off</sub>	Turn-Off Switching Loss	—	0.58	—		
E <sub>ts</sub>	Total Switching Loss	—	1.18	1.6		
t <sub>sc</sub>	Short Circuit Withstand Time	10	—	—	μs	V <sub>CC</sub> = 360V, T <sub>J</sub> = 125°C V <sub>GE</sub> = 15V, R <sub>G</sub> = 10Ω, V <sub>CPK</sub> < 500V
t <sub>d(on)</sub>	Turn-On Delay Time	—	58	—	ns	T <sub>J</sub> = 150°C, See Fig. 10,11,18 I <sub>C</sub> = 16A, V <sub>CC</sub> = 480V V <sub>GE</sub> = 15V, R <sub>G</sub> = 23Ω
t <sub>r</sub>	Rise Time	—	42	—		
t <sub>d(off)</sub>	Turn-Off Delay Time	—	210	—		
t <sub>f</sub>	Fall Time	—	160	—		
E <sub>ts</sub>	Total Switching Loss	—	1.69	—	mJ	Energy losses include "tail" and diode reverse recovery
L <sub>E</sub>	Internal Emitter Inductance	—	7.5	—	nH	Measured 5mm from package
C <sub>ies</sub>	Input Capacitance	—	920	—	pF	V <sub>GE</sub> = 0V V <sub>CC</sub> = 30V See Fig. 7
C <sub>oes</sub>	Output Capacitance	—	110	—		
C <sub>res</sub>	Reverse Transfer Capacitance	—	27	—		
t <sub>rr</sub>	Diode Reverse Recovery Time	—	42	60	ns	T <sub>J</sub> = 25°C See Fig. 14
		—	80	120		T <sub>J</sub> = 125°C
I <sub>rr</sub>	Diode Peak Reverse Recovery Current	—	3.5	6.0	A	T <sub>J</sub> = 25°C See Fig. 15
		—	5.6	10		T <sub>J</sub> = 125°C
Q <sub>rr</sub>	Diode Reverse Recovery Charge	—	80	180	nC	T <sub>J</sub> = 25°C See Fig. 16
		—	220	600		T <sub>J</sub> = 125°C
di <sub>(rec)</sub> /dt	Diode Peak Rate of Fall of Recovery During t <sub>b</sub>	—	180	—	A/μs	T <sub>J</sub> = 25°C See Fig. 17
		—	160	—		T <sub>J</sub> = 125°C

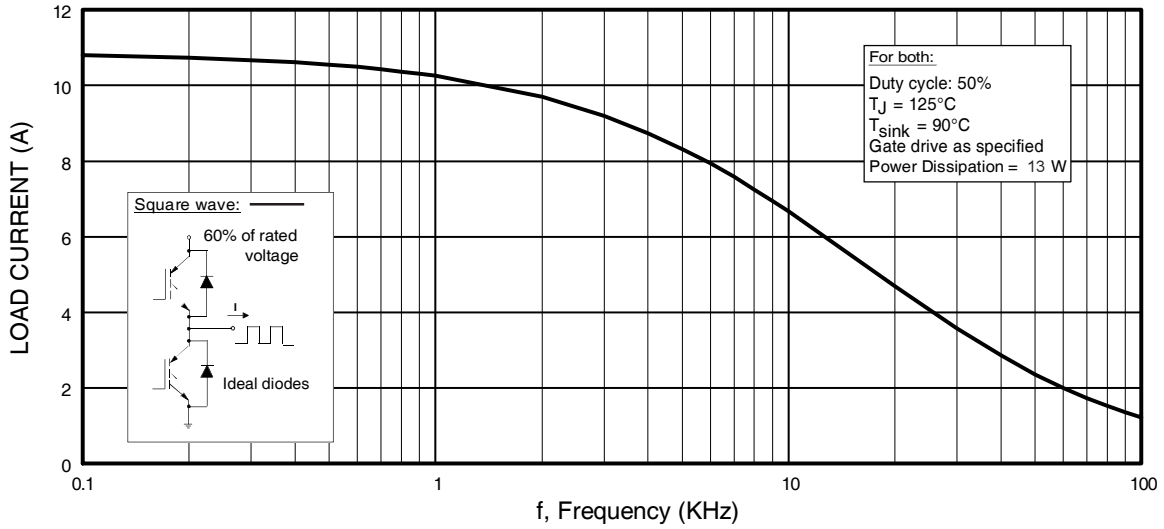

**Fig. 1 - Typical Load Current vs. Frequency**  
 (Load Current =  $I_{\text{RMS}}$  of fundamental)

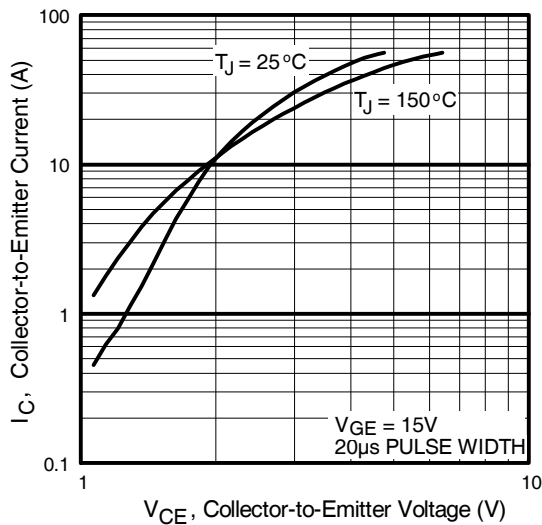

**Fig. 2 - Typical Output Characteristics**

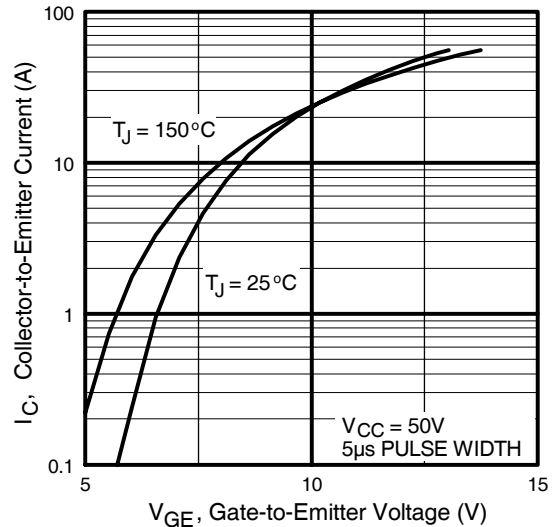

**Fig. 3 - Typical Transfer Characteristics**

# IRG4IBC30KDPbF

International  
**IRF** Rectifier

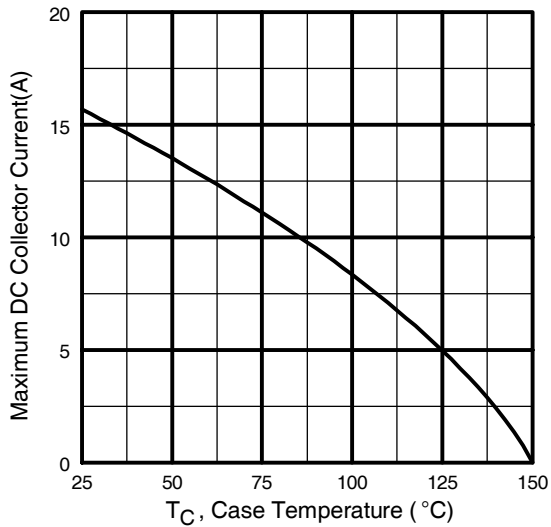

**Fig. 4 - Maximum Collector Current vs. Case Temperature**

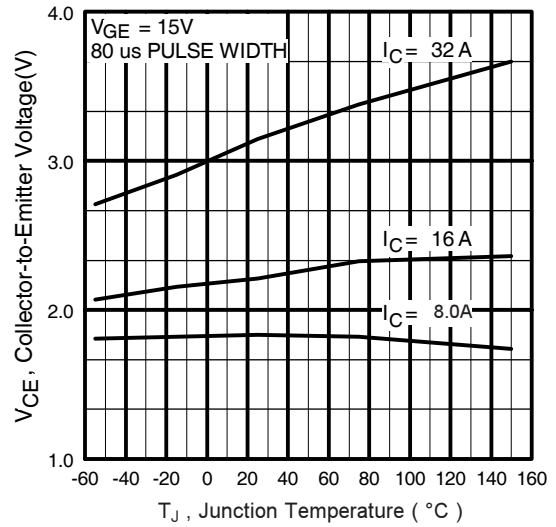

**Fig. 5 - Typical Collector-to-Emitter Voltage vs. Junction Temperature**

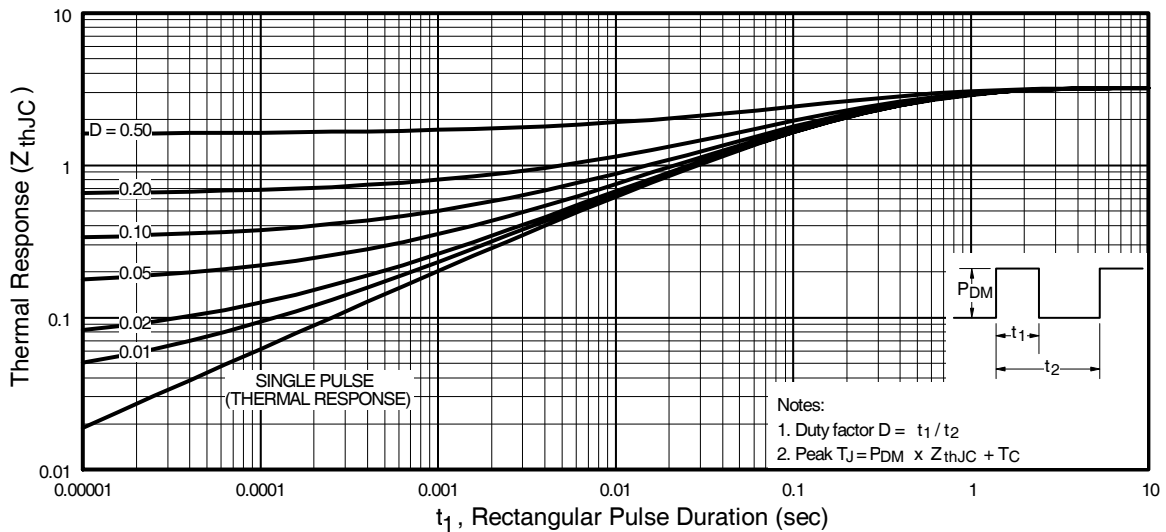

**Fig. 6 - Maximum Effective Transient Thermal Impedance, Junction-to-Case**

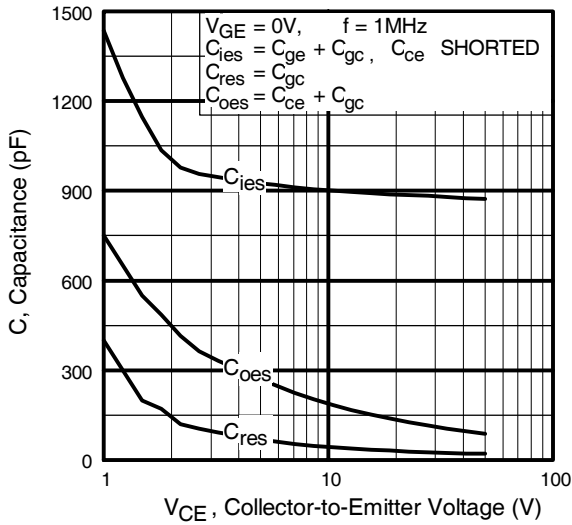

**Fig. 7** - Typical Capacitance vs. Collector-to-Emitter Voltage

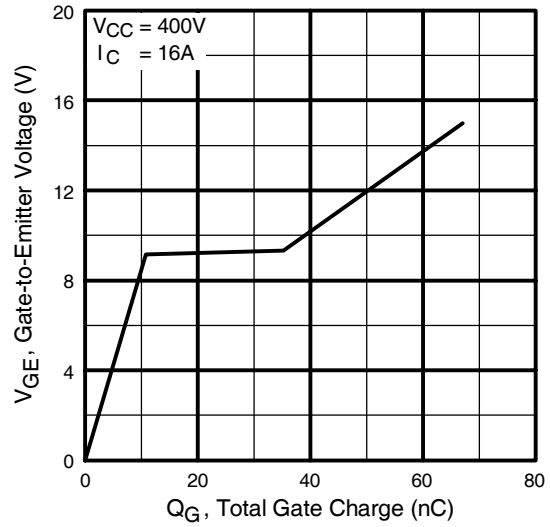

**Fig. 8** - Typical Gate Charge vs. Gate-to-Emitter Voltage

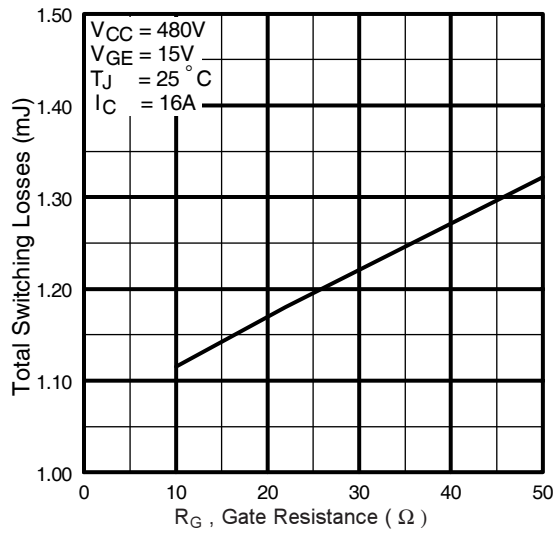

**Fig. 9** - Typical Switching Losses vs. Gate Resistance

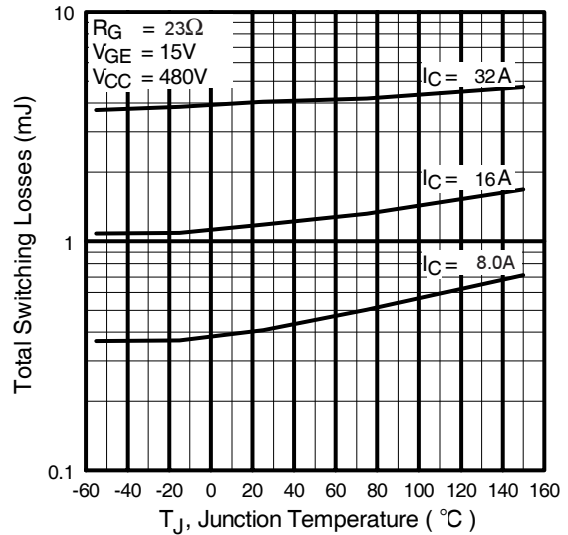

**Fig. 10** - Typical Switching Losses vs. Junction Temperature

# IRG4IBC30KDPbF

International  
**IR** Rectifier

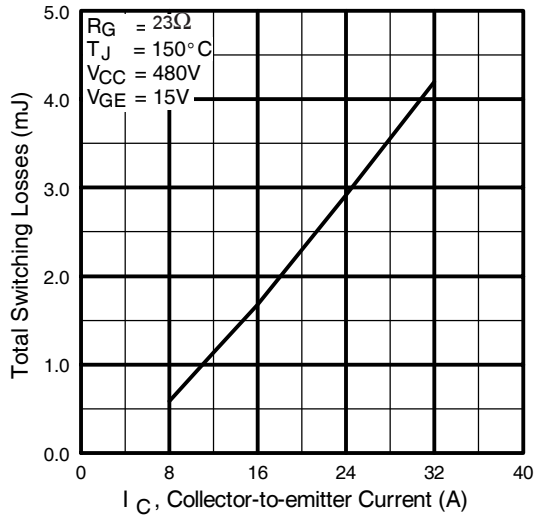

**Fig. 11** - Typical Switching Losses vs. Collector-to-Emitter Current

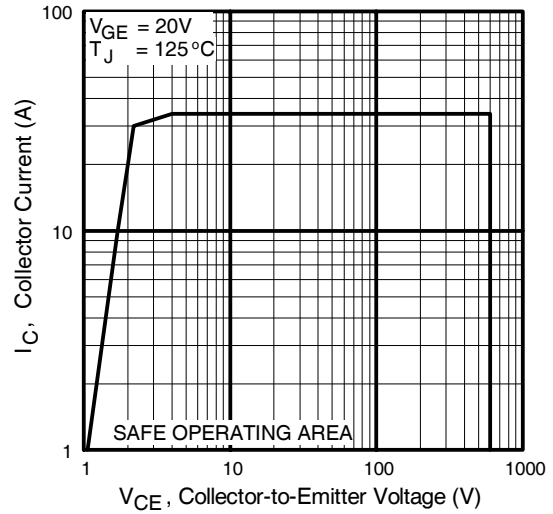

**Fig. 12** - Turn-Off SOA

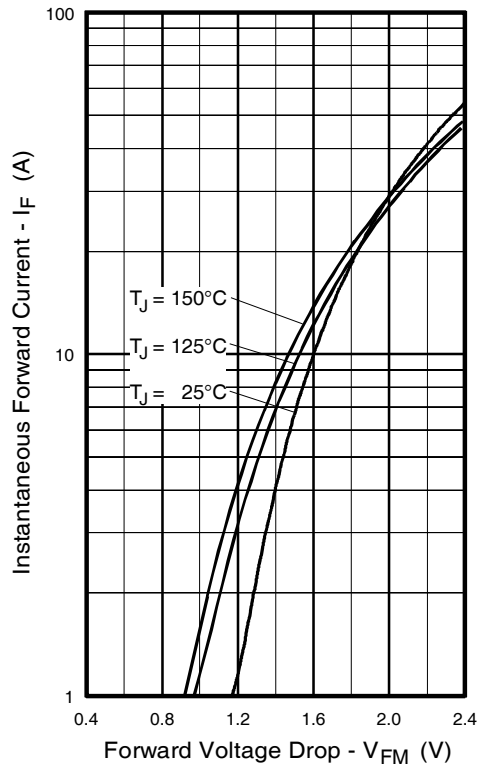

**Fig. 13** - Maximum Forward Voltage Drop vs. Instantaneous Forward Current

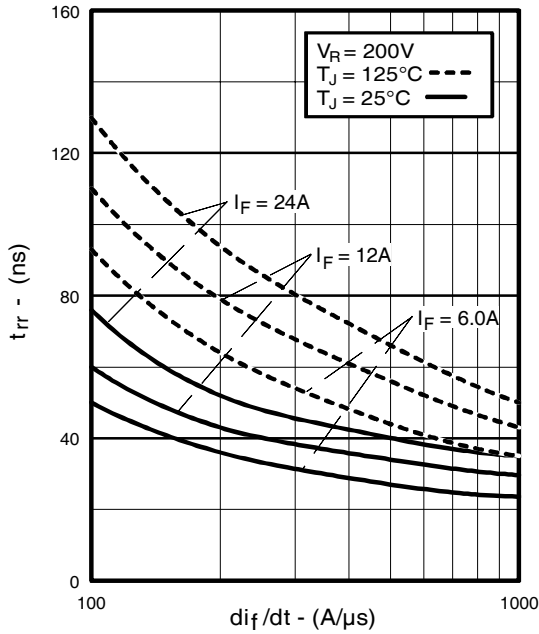

Fig. 14 - Typical Reverse Recovery vs.  $di_f/dt$

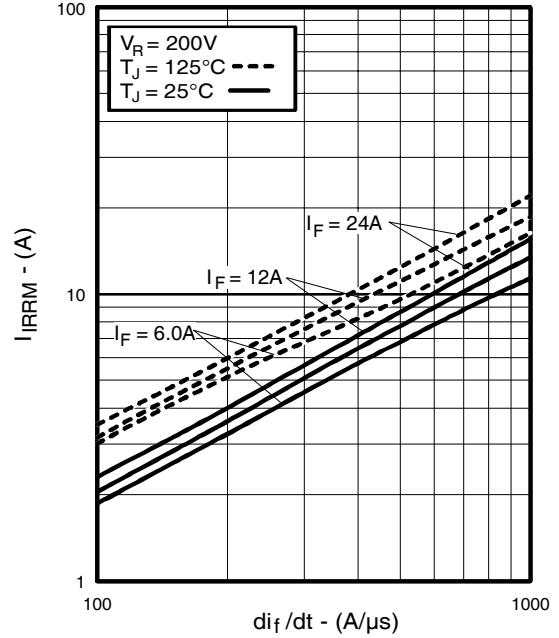

Fig. 15 - Typical Recovery Current vs.  $di_f/dt$

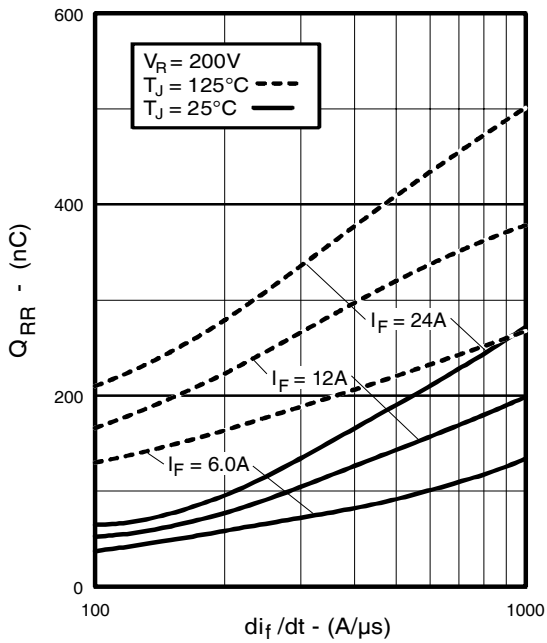

Fig. 16 - Typical Stored Charge vs.  $di_f/dt$

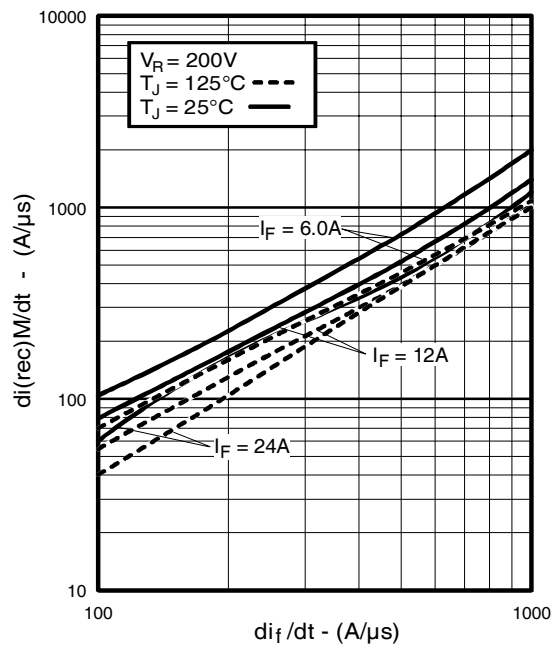
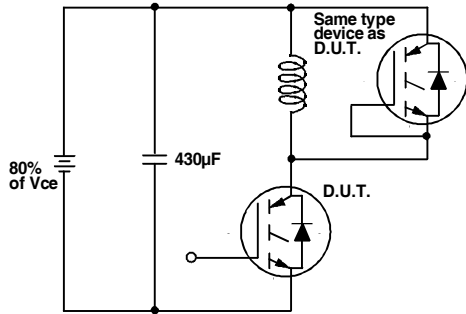

Fig. 17 - Typical  $di_{(rec)M}/dt$  vs.  $di_f/dt$

# IRG4IBC30KDPbF

International  
**IRF** Rectifier



**Fig. 18a** - Test Circuit for Measurement of  $I_{LM}$ ,  $E_{on}$ ,  $E_{off}(\text{diode})$ ,  $t_{rr}$ ,  $Q_{rr}$ ,  $I_{rr}$ ,  $t_{d(on)}$ ,  $t_r$ ,  $t_{d(off)}$ ,  $t_f$

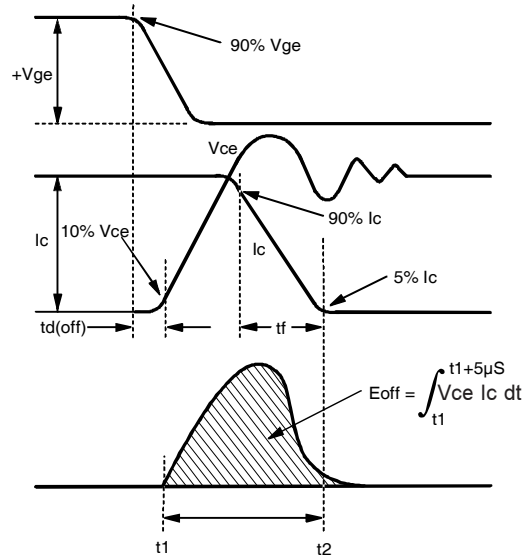

**Fig. 18b** - Test Waveforms for Circuit of Fig. 18a, Defining  $E_{off}$ ,  $t_{d(off)}$ ,  $t_f$

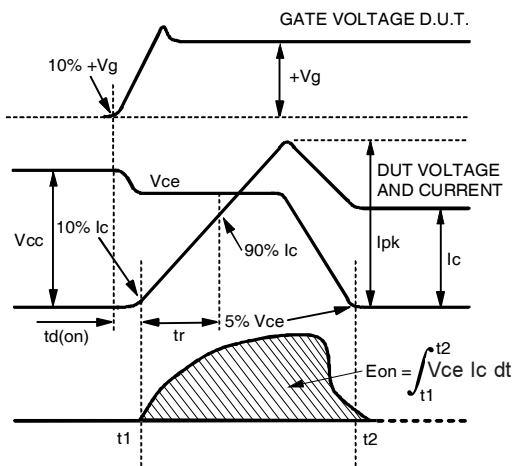

**Fig. 18c** - Test Waveforms for Circuit of Fig. 18a, Defining  $E_{on}$ ,  $t_{d(on)}$ ,  $t_r$

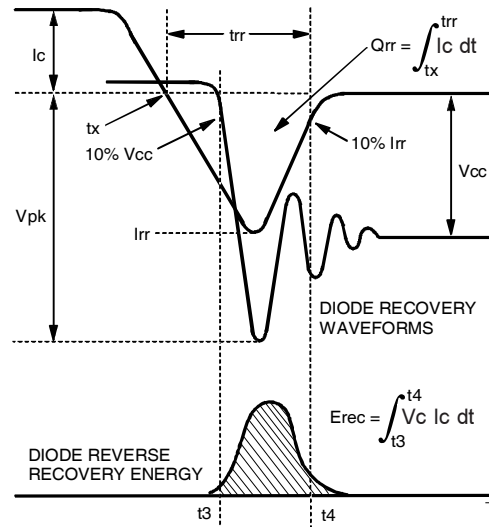

**Fig. 18d** - Test Waveforms for Circuit of Fig. 18a, Defining  $E_{rec}$ ,  $t_{rr}$ ,  $Q_{rr}$ ,  $I_{rr}$



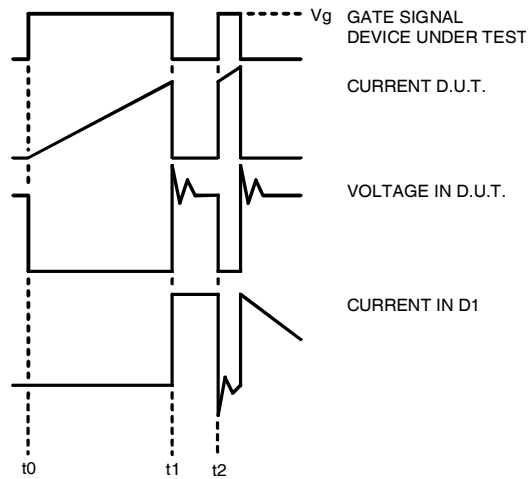

Figure 18e. Macro Waveforms for Figure 18a's Test Circuit

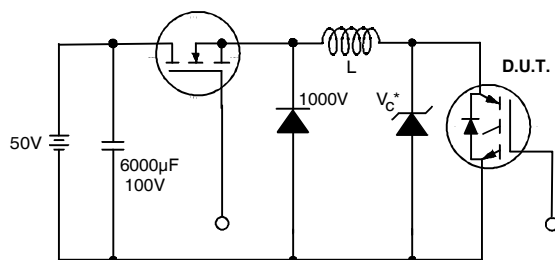

Figure 19. Clamped Inductive Load Test Circuit

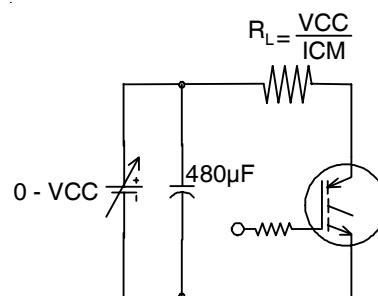

Figure 20. Pulsed Collector Current Test Circuit

# IRG4IBC30KDPbF

## TO-220AB Full-Pak Package Outline

International  
**IR** Rectifier

Dimensions are shown in millimeters (inches)

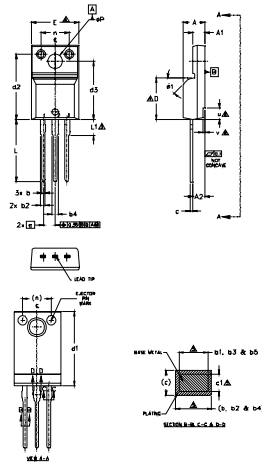

SYMBOL	DIMENSIONS				NOTES
	MILLIMETERS		INCHES		
	MIN.	MAX.	MIN.	MAX.	
A	4.57	4.83	.180	.190	NOTES: 1. DIMENSIONS AND TOLERANCING AS PER ASME Y14.5M-1994. 2. DIMENSIONS ARE SHOWN IN MILLIMETERS (INCHES). 3. LEAD DIMENSION AND FINISH UNCONTROLLED IN L.T. 4. DIMENSION D & E DO NOT INCLUDE WELD FLASH. WELD FLASH SHALL NOT EXCEED .007" (0.177) PER SIDE. THESE DIMENSIONS ARE MEASURED AT THE OUTER MOST EXTREMES OF THE PLASTIC BODY. 5. DIMENSION W & X AS APPLIED APPLY TO BARE METAL ONLY. 6. STEP OPTIMAL ON PLASTIC BODY DEFINED BY DIMENSIONS a & b. 7. CONTROLLING DIMENSION - NOTES.
A1	2.57	2.83	.101	.111	
A2	2.51	2.83	.099	.115	
b	0.61	0.94	.024	.037	
b1	0.61	0.89	.024	.035	
b2	0.76	1.27	.030	.050	
b3	0.76	1.22	.030	.048	
b4	1.02	1.52	.040	.060	
b5	1.02	1.47	.040	.058	
c	0.33	0.63	.013	.025	
c1	0.33	0.58	.013	.023	
D	8.66	9.80	.341	.386	
d1	15.80	16.15	.622	.635	
d2	13.97	14.22	.550	.560	
d3	12.30	12.93	.484	.509	
E	9.63	10.75	.379	.423	
e	2.54 BSC		.100 BSC		
L	13.20	13.72	.520	.540	
L1	3.37	3.67	.122	.145	
n	6.05	6.60	.238	.260	
φP	3.05	3.45	.120	.136	
u	2.40	2.50	.094	.098	
y	0.40	0.50	.016	.020	
φ1	-	45°	-	45°	

LEAD ASSIGNMENTS  
1 - GATE  
2 - DRAIN  
3 - SOURCE

IRG4IBC30KDPbF  
1 - GATE  
2 - COLLECTOR  
3 - EMITTER

## TO-220AB Full-Pak Part Marking Information

EXAMPLE: THIS IS AN IRFI840G  
WITH ASSEMBLY  
LOT CODE 3432  
ASSEMBLED ON WW 24, 2001  
IN THE ASSEMBLY LINE 'K'

Note: 'P' in assembly line position  
indicates 'Lead-Free'

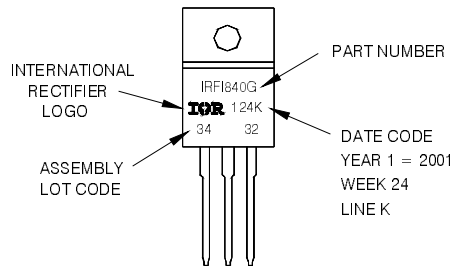

TO-220AB Full-Pak package is not recommended for Surface Mount Application.

### Notes:

- ① Repetitive rating:  $V_{GE}=20V$ ; pulse width limited by maximum junction temperature (figure 20).
- ②  $V_{CC}=80\%(V_{CES})$ ,  $V_{GE}=20V$ ,  $L=10\mu H$ ,  $R_G=23\Omega$  (figure 19).
- ③ Pulse width  $\leq 80\mu s$ ; duty factor  $\leq 0.1\%$ .
- ④ Pulse width  $5.0\mu s$ , single shot.
- ⑤ Uses IRG4IBC30KD data and test conditions.

Note: For the most current drawing please refer to IR website at <http://www.irf.com/package/>

Data and specifications subject to change without notice.

International  
**IR** Rectifier

IR WORLD HEADQUARTERS: 233 Kansas St., El Segundo, California 90245, USA Tel: (310) 252-7105  
TAC Fax: (310) 252-7903

Visit us at [www.irf.com](http://www.irf.com) for sales contact information.06/2010