



STGW35NB60SD

N-CHANNEL 35A - 600V - TO-247
Low Drop PowerMESH™ IGBT

General features

Type	V _{CES}	V _{CE(sat)} (Max) @ 25°C	I _C @ 100°C
STGW35NB60SD	600V	< 1.7V	35A

- LOW ON-VOLTAGE DROP (V_{CEsat})
- LOW INPUT CAPACITANCE
- HIGH CURRENT CAPABILITY

Description

Using the latest high voltage technology based on a patented strip layout, STMicroelectronics has designed an advanced family of IGBTs, the PowerMESH™ IGBTs, with outstanding performances.

Applications

- LIGHT DIMMER
- HID
- WELDING
- MOTOR CONTROL
- STATIC RELAYS

Order codes

Sales Type	Marking	Package	Packaging
STGW35NB60SD	GW35NB60SD	TO-247	TUBE

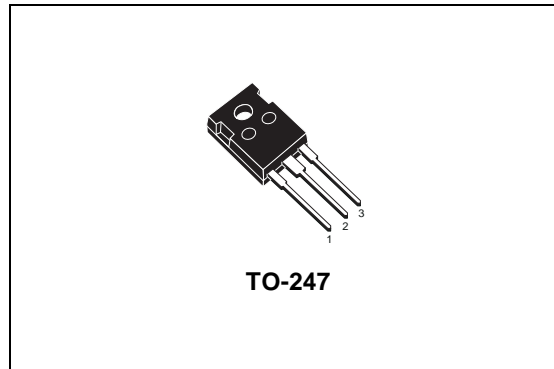

Internal schematic diagram

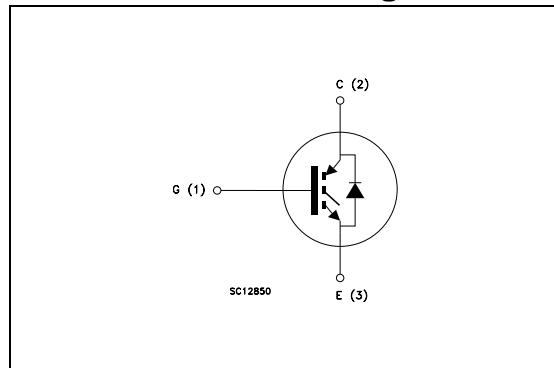

1 Electrical ratings

Table 1. Absolute maximum ratings

Symbol	Parameter	Value	Unit
V_{CES}	Collector-Emitter Voltage ($V_{GS} = 0$)	600	V
I_C <i>Note 4</i>	Collector Current (continuous) at 25°C	70	A
I_C <i>Note 4</i>	Collector Current (continuous) at 100°C	35	A
I_{CM} <i>Note 1</i>	Collector Current (pulsed)	250	A
V_{GE}	Gate-Emitter Voltage	± 20	V
I_f	Diode RMS Forward Current at $T_C = 25^\circ\text{C}$	30	A
P_{TOT}	Total Dissipation at $T_C = 25^\circ\text{C}$	200	W
T_j	Operating Junction Temperature	– 55 to 150	°C
T_{stg}	Storage Temperature		
T_L	Maximum Lead Temperature for Soldering Purpose (1.6mm from case, for 10sec.)	300	°C

Table 2. Thermal resistance

		Min.	Typ.	Max.	Unit
Rthj-case	Thermal Resistance Junction-case (IGBT)	--	--	0.625	°C/W
Rthj-case	Thermal Resistance Junction-case (DIODE)	--	--	1.5	°C/W
Rthj-amb	Thermal Resistance Junction-ambient	--	--	50	°C/W

2 Electrical characteristics

($T_{CASE} = 25\text{ °C}$ unless otherwise specified)

Table 3. Static

Symbol	Parameter	Test Conditions	Min.	Typ.	Max.	Unit
$V_{BR(CES)}$	Collector-Emitter Breakdown Voltage	$I_C = 1\text{mA}$, $V_{GE} = 0$	600			V
$V_{CE(SAT)}$	Collector-Emitter Saturation Voltage	$V_{GE} = 15\text{V}$, $I_C = 20\text{A}$, $T_j = 25\text{°C}$ $V_{GE} = 15\text{V}$, $I_C = 20\text{A}$, $T_j = 125\text{°C}$		1.25 1.2	1.7	V V
$V_{GE(th)}$	Gate Threshold Voltage	$V_{CE} = V_{GE}$, $I_C = 250\mu\text{A}$	2.5		5	V
I_{CES}	Collector-Emitter Leakage Current ($V_{GE} = 0$)	$V_{CE} = \text{Max Rating}$, $T_c = 25\text{°C}$ $V_{CE} = \text{Max Rating}$, $T_c = 125\text{°C}$			10 100	μA μA
I_{GES}	Gate-Emitter Leakage Current ($V_{CE} = 0$)	$V_{GE} = \pm 20\text{V}$, $V_{CE} = 0$			± 100	nA
g_{fs}	Forward Transconductance	$V_{CE} = 10\text{V}$, $I_C = 18\text{A}$		20		S

Table 4. Dynamic

Symbol	Parameter	Test Conditions	Min.	Typ.	Max.	Unit
C_{ies}	Input Capacitance	$V_{CE} = 25\text{V}$, $f = 1\text{MHz}$, $V_{GE} = 0$		1820		pF
C_{oes}	Output Capacitance			167		pF
C_{res}	Reverse Transfer Capacitance			27		pF
Q_g	Total Gate Charge	$V_{CE} = 480\text{V}$, $I_C = 20\text{A}$, $V_{GE} = 15\text{V}$, (see Figure 17)		83	115	nC
Q_{ge}	Gate-Emitter Charge			10		nC
Q_{gc}	Gate-Collector Charge			27		nC
I_{CL}	Turn-Off SOA Minimum Current	$V_{clamp} = 480\text{V}$, $T_j = 125\text{°C}$ $R_G = 100\Omega$	80			A

Table 5. Switching on/off (inductive load)

Symbol	Parameter	Test Conditions	Min.	Typ.	Max.	Unit
$t_{d(on)}$	Turn-on Delay Time	$V_{CC} = 480V, I_C = 20A$		92		ns
t_r	Current Rise Time	$R_G = 100\Omega, V_{GE} = 15V, T_J = 25^\circ C$		70		ns
$(di/dt)_{on}$	Turn-on Current Slope	(see Figure 3)		340		A/ μs
$t_{d(on)}$	Turn-on Delay Time	$V_{CC} = 480V, I_C = 20A$		80		ns
t_r	Current Rise Time	$R_G = 100\Omega, V_{GE} = 15V, T_J = 125^\circ C$		73		ns
$(di/dt)_{on}$	Turn-on Current Slope	(see Figure 3)		320		A/ μs
$t_r(V_{off})$	Off Voltage Rise Time	$V_{CC} = 480V, I_C = 20A,$		0.78		μs
$t_{d(off)}$	Turn-off Delay Time	$R_{GE} = 100\Omega, V_{GE} = 5V, T_J = 25^\circ C$		1.1		μs
t_f	Current Fall Time	(see Figure 18)		0.79		μs
$t_r(V_{off})$	Off Voltage Rise Time	$V_{CC} = 480V, I_C = 20A,$		1.1		μs
$t_{d(off)}$	Turn-off Delay Time	$R_{GE} = 100\Omega, V_{GE} = 15V, T_J = 125^\circ C$		2.4		μs
t_f	Current Fall Time	(see Figure 18)		1.2		μs

Table 6. Switching energy (inductive load)

Symbol	Parameter	Test Conditions	Min.	Typ.	Max.	Unit
E_{on} <i>Note 2</i>	Turn-on Switching Losses	$V_{CC} = 480V, I_C = 20A$		0.84		mJ
E_{off} <i>Note 3</i>	Turn-off Switching Losses	$R_G = 100\Omega, V_{GE} = 15V, T_J = 25^\circ C$		7.4		mJ
E_{ts}	Total Switching Losses	(see Figure 18)		8.24		mJ
E_{on} <i>Note 2</i>	Turn-on Switching Losses	$V_{CC} = 480V, I_C = 20A$		0.86		mJ
E_{off} <i>Note 3</i>	Turn-off Switching Losses	$R_G = 100\Omega, V_{GE} = 15V, T_J = 125^\circ C$		11.5		mJ
E_{ts}	Total Switching Losses	(see Figure 18)		12.4		mJ

Table 7. Collector-emitter diode

Symbol	Parameter	Test Conditions	Min.	Typ.	Max.	Unit
V_f	Forward On-Voltage	$I_f = 10A$ $I_f = 10A, T_j = 125^\circ C$		1.3 1	2	V V
t_{rr} t_a Q_{rr} I_{rrm} S	Reverse Recovery Time Reverse Recovery Charge Reverse Recovery Current Softness factor of the diode	$I_f = 20A, V_R = 40V,$ $T_j = 25^\circ C, di/dt = 100A/\mu s$ (see Figure 19)		44 32 66 3 0.375		ns ns nC A
t_{rr} t_a Q_{rr} I_{rrm} S	Reverse Recovery Time Reverse Recovery Charge Reverse Recovery Current Softness factor of the diode	$I_f = 20A, V_R = 40V,$ $T_j = 125^\circ C, di/dt = 100A/\mu s$ (see Figure 19)		88 56 237 5.4 0.57		ns ns nC A

(1) Pulse width limited by max. junction temperature

(2) E_{on} is the turn-on losses when a typical diode is used in the test circuit in figure 2. E_{on} include diode recovery energy. If the IGBT is offered in a package with a co-pak diode, the co-pak diode is used as external diode. IGBTs & Diode are at the same temperature (25°C and 125°C)

(3) Turn-off losses include also the tail of the collector current

(4) Calculated according to the iterative formula:

$$I_C(T_C) = \frac{T_{JMAX} - T_C}{R_{THJ-C} \times V_{CESAT(MAX)}(T_C, I_C)}$$

2.1 Electrical characteristics (curves)

Figure 1. Output Characteristics

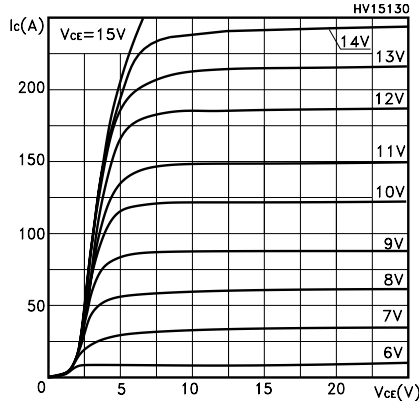

Figure 2. Transfer Characteristics

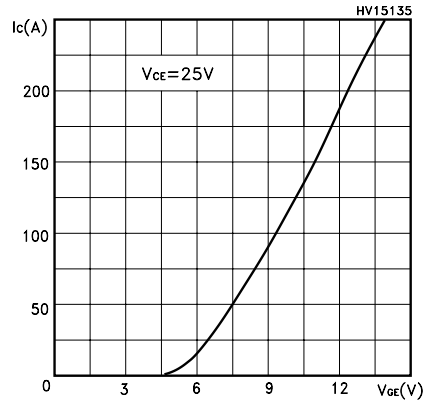

Figure 3. Transconductance

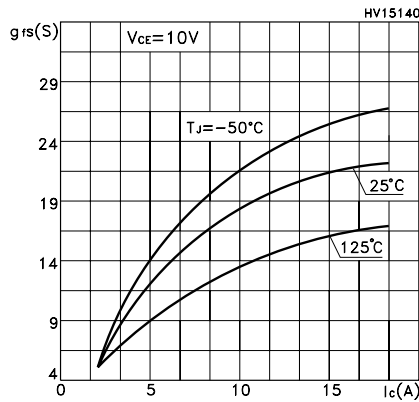

Figure 4. Normalized Collector-Emitter On Voltage vs Temperature

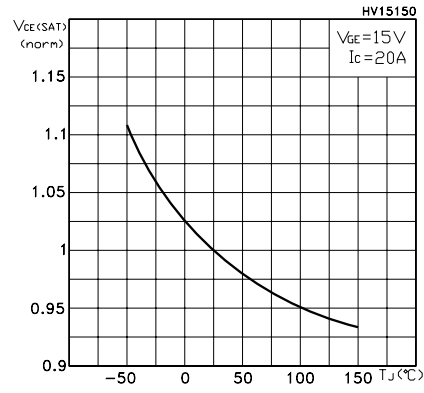

Figure 5. Collector-Emitter on Voltage vs Collector Current

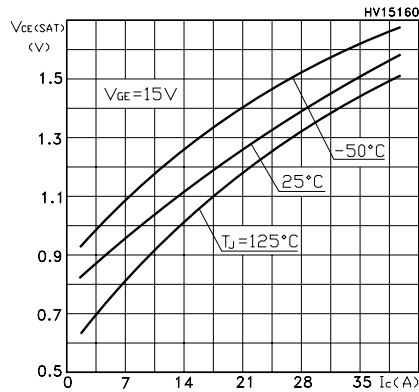

Figure 6. Gate Threshold vs Temperature

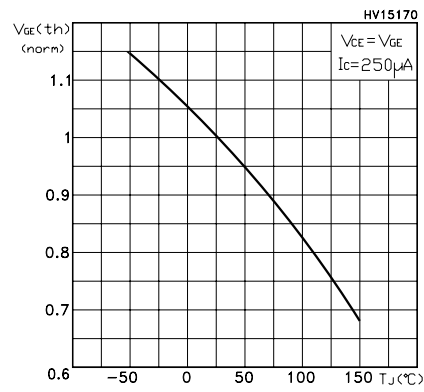

Figure 7. Normalized Breakdown Voltage vs Temperature

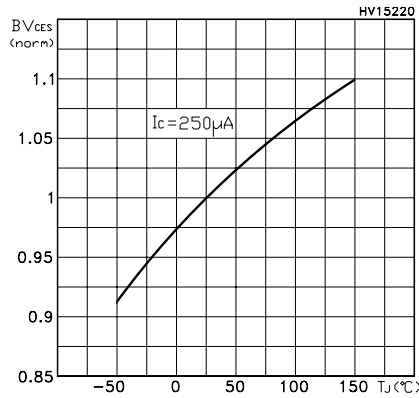

Figure 8. Gate Charge vs Gate-Emitter Voltage

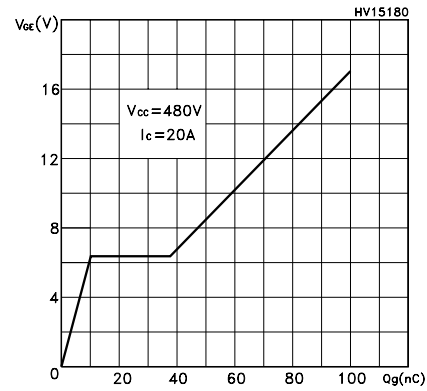

Figure 9. Capacitance Variations

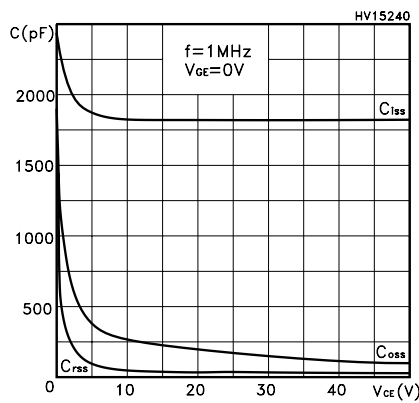

Figure 10. Switching Losses vs Gate Charge

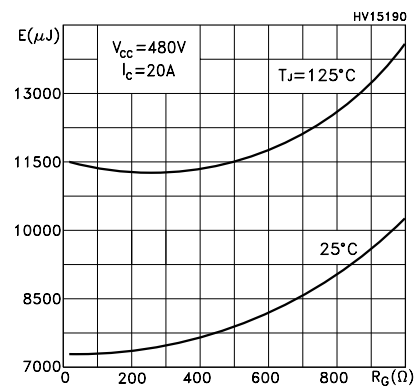

Figure 11. Switching Losses vs Temperature

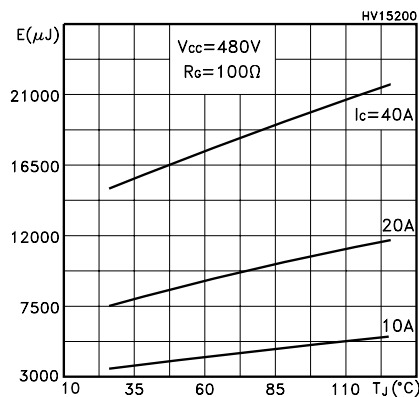

Figure 12. Switching Losses vs Collector Current

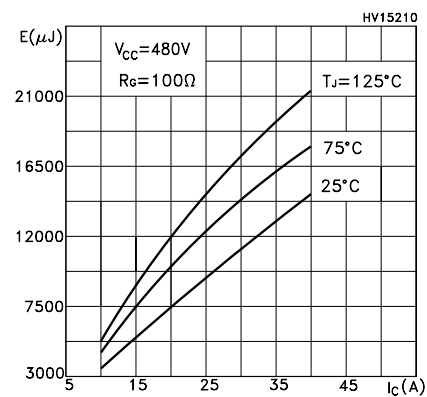

Figure 13. Thermal Impedance

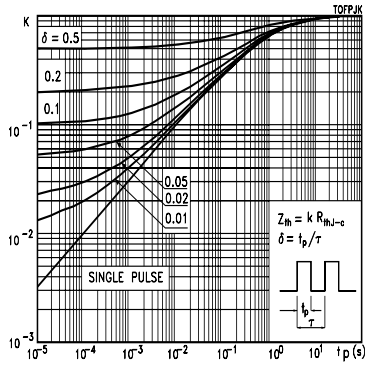

Figure 14. Turn-Off SOA

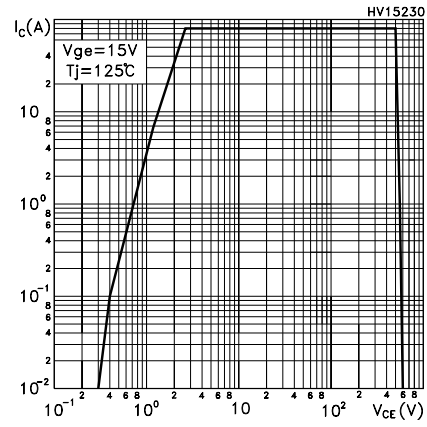
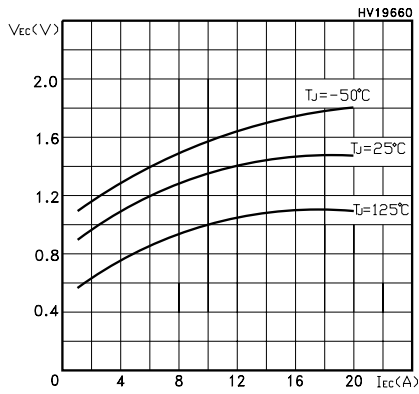

Figure 15. Emitter-Collector Diode Characteristics



3 Test Circuits

Figure 16. Test Circuit for Inductive Load Switching

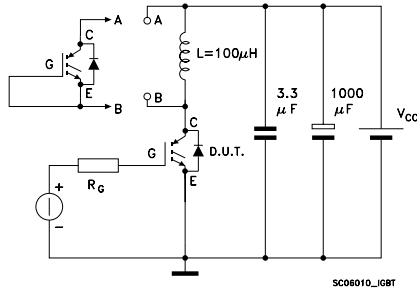

Figure 17. Gate Charge Test Circuit

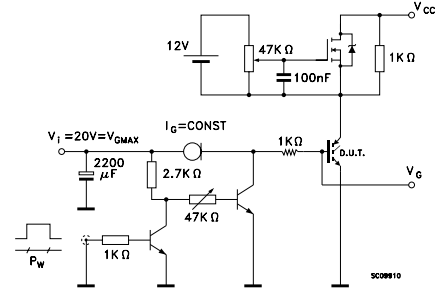

Figure 18. Switching Waveform

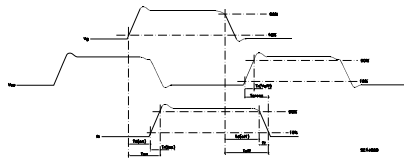
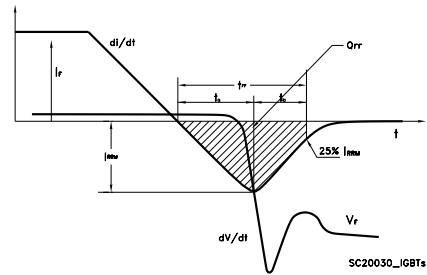

Figure 19. Diode Recovery Time Waveform



4 Package mechanical data

In order to meet environmental requirements, ST offers these devices in ECOPACK® packages. These packages have a Lead-free second level interconnect . The category of second level interconnect is marked on the package and on the inner box label, in compliance with JEDEC Standard JESD97. The maximum ratings related to soldering conditions are also marked on the inner box label. ECOPACK is an ST trademark. ECOPACK specifications are available at: www.st.com

TO-247 MECHANICAL DATA

DIM.	mm.			inch		
	MIN.	TYP.	MAX.	MIN.	TYP.	MAX.
A	4.85		5.15	0.19		0.20
A1	2.20		2.60	0.086		0.102
b	1.0		1.40	0.039		0.055
b1	2.0		2.40	0.079		0.094
b2	3.0		3.40	0.118		0.134
c	0.40		0.80	0.015		0.03
D	19.85		20.15	0.781		0.793
E	15.45		15.75	0.608		0.620
e		5.45			0.214	
L	14.20		14.80	0.560		0.582
L1	3.70		4.30	0.14		0.17
L2		18.50			0.728	
øP	3.55		3.65	0.140		0.143
øR	4.50		5.50	0.177		0.216
S		5.50			0.216	

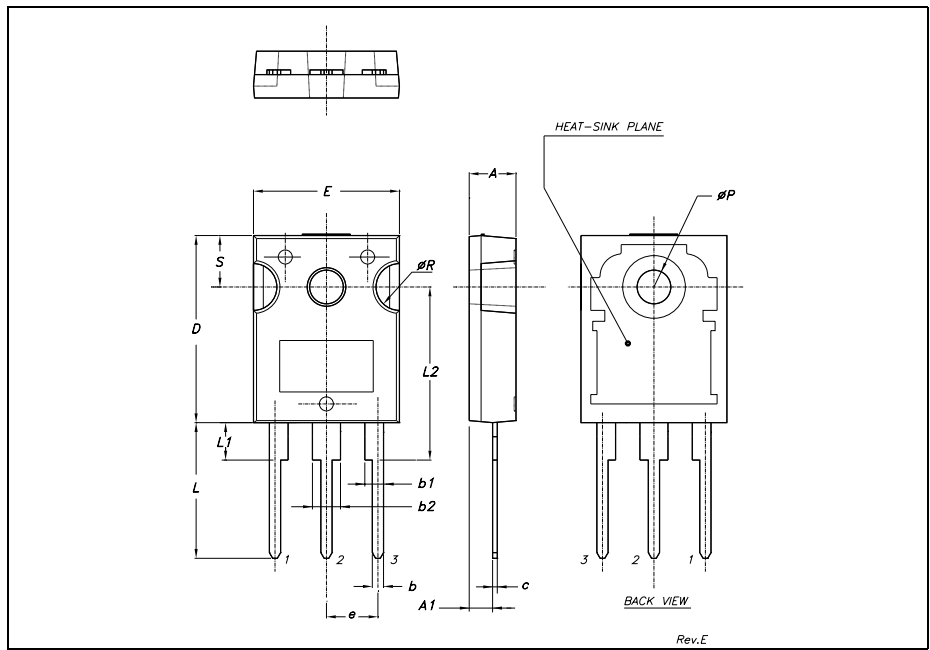

5 Revision History

Date	Revision	Changes
16-Nov-2005	1	Initial release.

Information furnished is believed to be accurate and reliable. However, STMicroelectronics assumes no responsibility for the consequences of use of such information nor for any infringement of patents or other rights of third parties which may result from its use. No license is granted by implication or otherwise under any patent or patent rights of STMicroelectronics. Specifications mentioned in this publication are subject to change without notice. This publication supersedes and replaces all information previously supplied. STMicroelectronics products are not authorized for use as critical components in life support devices or systems without express written approval of STMicroelectronics.

The ST logo is a registered trademark of STMicroelectronics.
All other names are the property of their respective owners

© 2005 STMicroelectronics - All rights reserved

STMicroelectronics group of companies

Australia - Belgium - Brazil - Canada - China - Czech Republic - Finland - France - Germany - Hong Kong - India - Israel - Italy - Japan -
Malaysia - Malta - Morocco - Singapore - Spain - Sweden - Switzerland - United Kingdom - United States of America

www.st.com

