

IRG4BC10UDPbF

INSULATED GATE BIPOLAR TRANSISTOR WITH ULTRAFast SOFT RECOVERY DIODE UltraFast CoPack IGBT

Features

- UltraFast: Optimized for high operating up to 80 kHz in hard switching, >200 kHz in resonant mode
- Generation 4 IGBT design provides tighter parameter distribution and higher efficiency than previous Generation
- IGBT co-packaged with HEXFRED™ ultrafast, ultra-soft-recovery anti-parallel diodes for use in bridge configurations
- Industry standard TO-220AB package
- Lead-Free

Benefits

- Generation 4 IGBT's offer highest efficiencies available
- IGBT's optimized for specific application conditions
- HEXFRED diodes optimized for performance with IGBT's . Minimized recovery characteristics require less/no snubbing

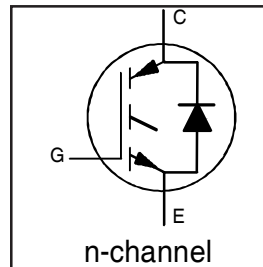

| |
|------------------------------|
| $V_{CES} = 600V$ |
| $V_{CE(on) typ.} = 2.15V$ |
| @ $V_{GE} = 15V, I_C = 5.0A$ |
| $t_f (typ.) = 140ns$ |

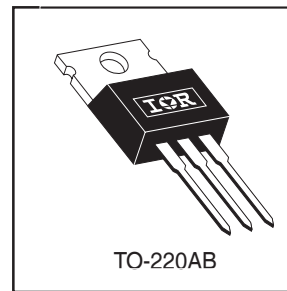

Absolute Maximum Ratings

| | Parameter | Max. | Units |
|---------------------------|------------------------------------|-----------------------------------|-------|
| V_{CES} | Collector-to-Emitter Voltage | 600 | V |
| $I_C @ T_C = 25^\circ C$ | Continuous Collector Current | 8.5 | A |
| $I_C @ T_C = 100^\circ C$ | Continuous Collector Current | 5.0 | |
| I_{CM} | Pulsed Collector Current ① | 34 | |
| I_{LM} | Clamped Inductive Load Current ② | 34 | |
| $I_F @ T_C = 100^\circ C$ | Diode Continuous Forward Current | 4.0 | |
| I_{FM} | Diode Maximum Forward Current | 16 | |
| V_{GE} | Gate-to-Emitter Voltage | ± 20 | V |
| $P_D @ T_C = 25^\circ C$ | Maximum Power Dissipation | 38 | W |
| $P_D @ T_C = 100^\circ C$ | Maximum Power Dissipation | 15 | |
| T_J | Operating Junction and | -55 to +150 | °C |
| T_{STG} | Storage Temperature Range | | |
| | Soldering Temperature, for 10 sec. | 300 (0.063 in. (1.6mm) from case) | |
| | Mounting Torque, 6-32 or M3 Screw. | 10 lbf•in (1.1 N•m) | |

Thermal Resistance

| | Parameter | Min. | Typ. | Max. | Units |
|-----------------|---|------|----------|------|--------|
| $R_{\theta JC}$ | Junction-to-Case - IGBT | — | — | 3.3 | °C/W |
| $R_{\theta JC}$ | Junction-to-Case - Diode | — | — | 7.0 | |
| $R_{\theta CS}$ | Case-to-Sink, flat, greased surface | — | 0.50 | — | |
| $R_{\theta JA}$ | Junction-to-Ambient, typical socket mount | — | — | 80 | |
| Wt | Weight | — | 2 (0.07) | — | g (oz) |

IRG4BC10UDPbF

Electrical Characteristics @ T_J = 25°C (unless otherwise specified)

| | Parameter | Min. | Typ. | Max. | Units | Conditions |
|--|---|------|------|------|-------|---|
| V _{(BR)CES} | Collector-to-Emitter Breakdown Voltage ^③ | 600 | — | — | V | V _{GE} = 0V, I _C = 250μA |
| ΔV _{(BR)CES} /ΔT _J | Temperature Coeff. of Breakdown Voltage | — | 0.54 | — | V/°C | V _{GE} = 0V, I _C = 1.0mA |
| V _{CE(on)} | Collector-to-Emitter Saturation Voltage | — | 2.15 | 2.6 | V | I _C = 5.0A I _C = 8.5A I _C = 5.0A, T _J = 150°C V _{GE} = 15V See Fig. 2, 5 |
| | | — | 2.61 | — | | |
| | | — | 2.30 | — | | |
| V _{GE(th)} | Gate Threshold Voltage | 3.0 | — | 6.0 | | V _{CE} = V _{GE} , I _C = 250μA |
| ΔV _{GE(th)} /ΔT _J | Temperature Coeff. of Threshold Voltage | — | -8.7 | — | mV/°C | V _{CE} = V _{GE} , I _C = 250μA |
| g _{fe} | Forward Transconductance ^④ | 2.8 | 4.2 | — | S | V _{CE} = 100V, I _C = 5.0A |
| I _{CES} | Zero Gate Voltage Collector Current | — | — | 250 | μA | V _{GE} = 0V, V _{CE} = 600V |
| | | — | — | 1000 | | V _{GE} = 0V, V _{CE} = 600V, T _J = 150°C |
| V _{FM} | Diode Forward Voltage Drop | — | 1.5 | 1.8 | V | I _C = 4.0A See Fig. 13 |
| | | — | 1.4 | 1.7 | | I _C = 4.0A, T _J = 125°C |
| I _{GES} | Gate-to-Emitter Leakage Current | — | — | ±100 | nA | V _{GE} = ±20V |

Switching Characteristics @ T_J = 25°C (unless otherwise specified)

| | Parameter | Min. | Typ. | Max. | Units | Conditions |
|--------------------------|---|------|------|------|-------|--|
| Q _g | Total Gate Charge (turn-on) | — | 15 | 22 | nC | I _C = 5.0A V _{CC} = 400V V _{GE} = 15V See Fig. 8 |
| Q _{ge} | Gate - Emitter Charge (turn-on) | — | 2.6 | 4.0 | | |
| Q _{gc} | Gate - Collector Charge (turn-on) | — | 5.8 | 8.7 | | |
| t _{d(on)} | Turn-On Delay Time | — | 40 | — | ns | T _J = 25°C I _C = 5.0A, V _{CC} = 480V V _{GE} = 15V, R _G = 100Ω Energy losses include "tail" and diode reverse recovery. See Fig. 9, 10, 18 |
| t _r | Rise Time | — | 16 | — | | |
| t _{d(off)} | Turn-Off Delay Time | — | 87 | 130 | | |
| t _f | Fall Time | — | 140 | 210 | | |
| E _{on} | Turn-On Switching Loss | — | 0.14 | — | | |
| E _{off} | Turn-Off Switching Loss | — | 0.12 | — | mJ | |
| E _{ts} | Total Switching Loss | — | 0.26 | 0.33 | | |
| t _{d(on)} | Turn-On Delay Time | — | 38 | — | ns | T _J = 150°C, See Fig. 11, 18 I _C = 5.0A, V _{CC} = 480V V _{GE} = 15V, R _G = 100Ω Energy losses include "tail" and diode reverse recovery. |
| t _r | Rise Time | — | 18 | — | | |
| t _{d(off)} | Turn-Off Delay Time | — | 95 | — | | |
| t _f | Fall Time | — | 250 | — | | |
| E _{ts} | Total Switching Loss | — | 0.45 | — | | |
| L _E | Internal Emitter Inductance | — | 7.5 | — | nH | Measured 5mm from package |
| C _{ies} | Input Capacitance | — | 270 | — | pF | V _{GE} = 0V V _{CC} = 30V f = 1.0MHz See Fig. 7 |
| C _{oes} | Output Capacitance | — | 21 | — | | |
| C _{res} | Reverse Transfer Capacitance | — | 3.5 | — | | |
| t _{rr} | Diode Reverse Recovery Time | — | 28 | 42 | ns | T _J = 25°C See Fig. 14 T _J = 125°C |
| | | — | 38 | 57 | | |
| I _{rr} | Diode Peak Reverse Recovery Current | — | 2.9 | 5.2 | A | T _J = 25°C See Fig. 15 T _J = 125°C |
| | | — | 3.7 | 6.7 | | |
| Q _{rr} | Diode Reverse Recovery Charge | — | 40 | 60 | nC | T _J = 25°C See Fig. 16 T _J = 125°C |
| | | — | 70 | 105 | | |
| di _{(rec)M} /dt | Diode Peak Rate of Fall of Recovery During t _b | — | 280 | — | A/μs | T _J = 25°C See Fig. 17 T _J = 125°C |
| | | — | 235 | — | | |

Details of note ① through ④ are on the last page

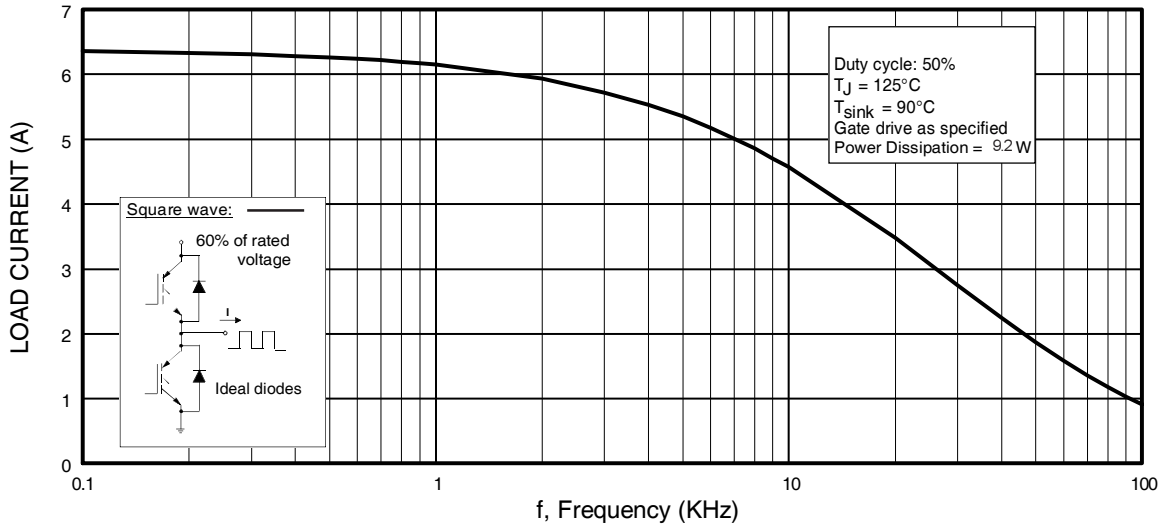

Fig. 1 - Typical Load Current vs. Frequency
 (Load Current = I_{RMS} of fundamental)

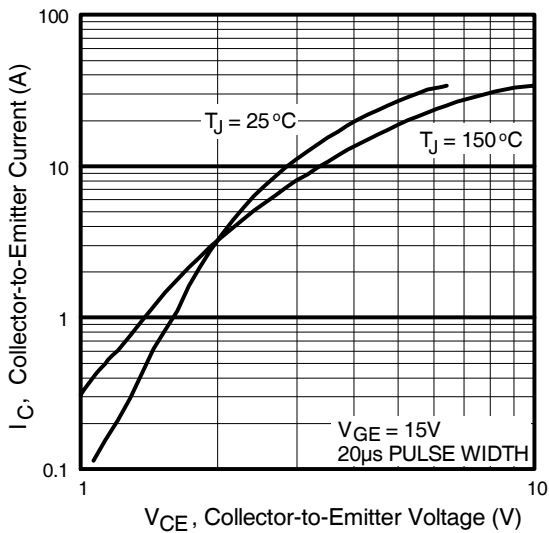

Fig. 2 - Typical Output Characteristics
www.irf.com

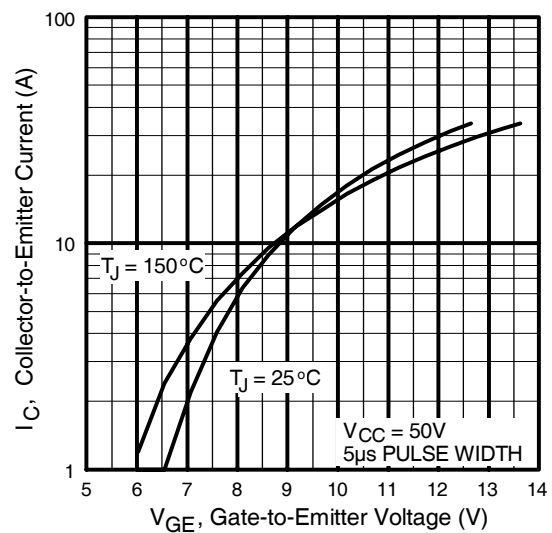

Fig. 3 - Typical Transfer Characteristics

IRG4BC10UDPbF

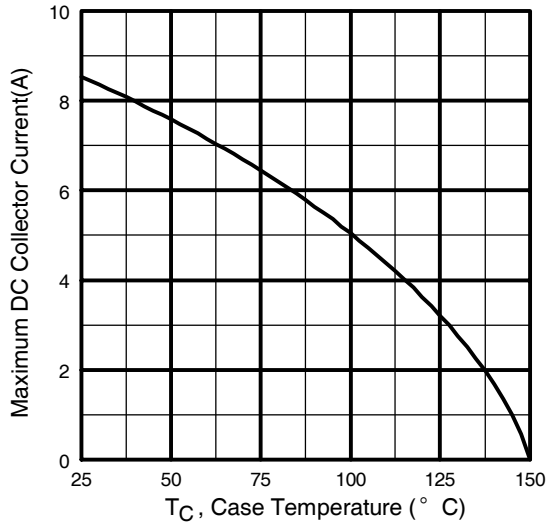

Fig. 4 - Maximum Collector Current vs. Case Temperature

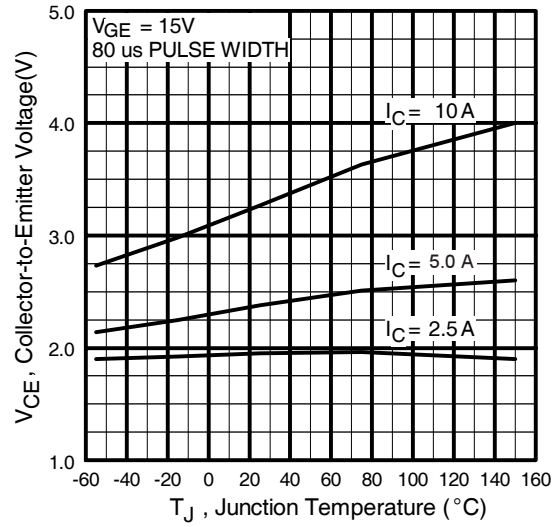

Fig. 5 - Typical Collector-to-Emitter Voltage vs. Junction Temperature

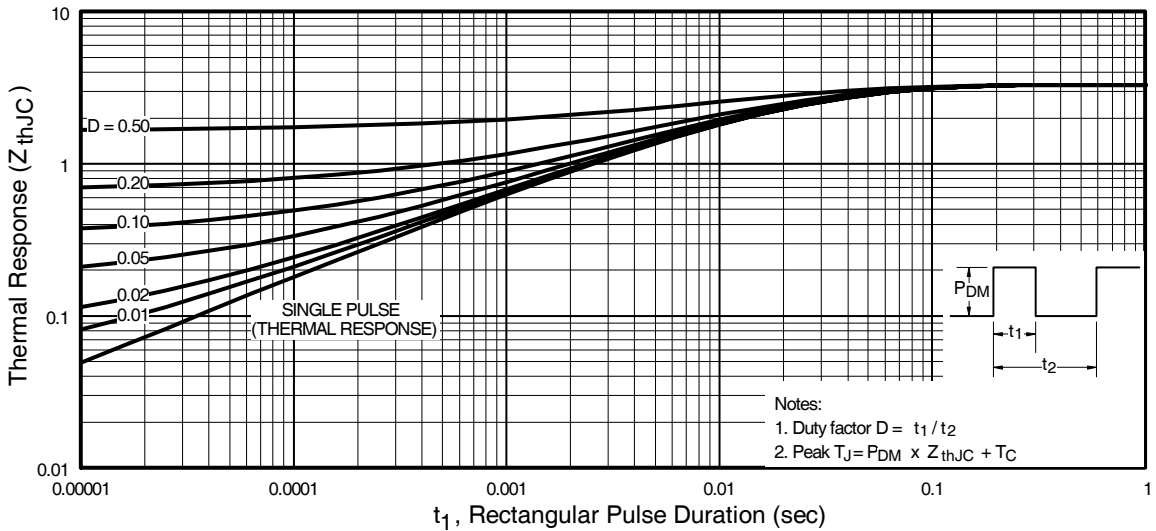

Fig. 6 - Maximum Effective Transient Thermal Impedance, Junction-to-Case

IRG4BC10UDPbF

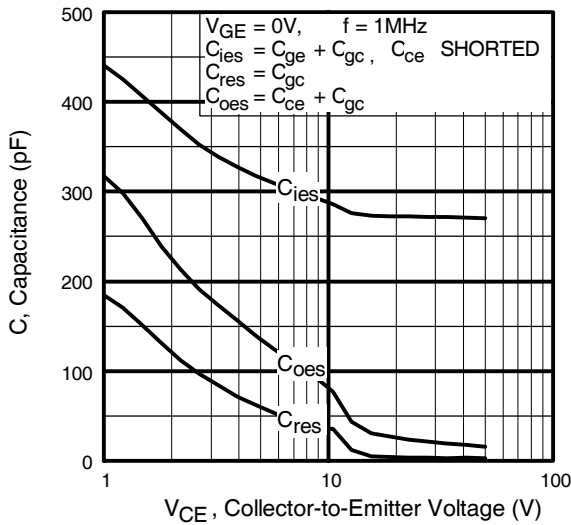

Fig. 7 - Typical Capacitance vs. Collector-to-Emitter Voltage

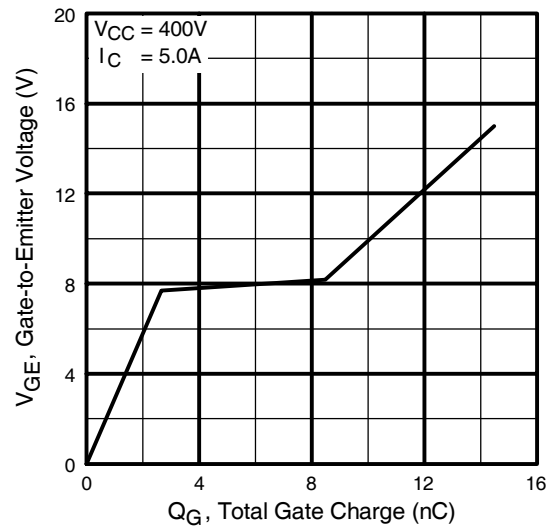

Fig. 8 - Typical Gate Charge vs. Gate-to-Emitter Voltage

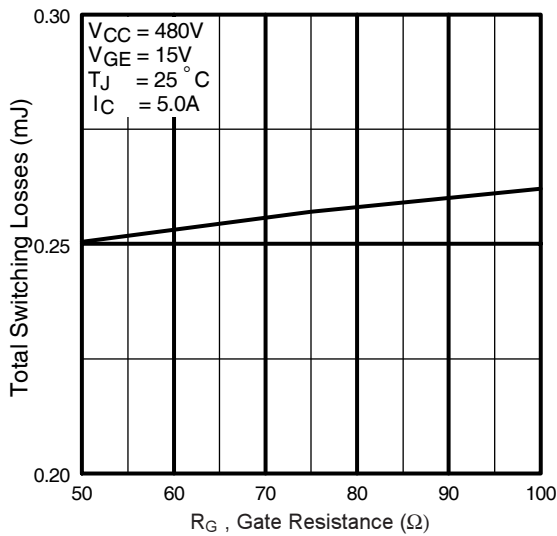

Fig. 9 - Typical Switching Losses vs. Gate Resistance

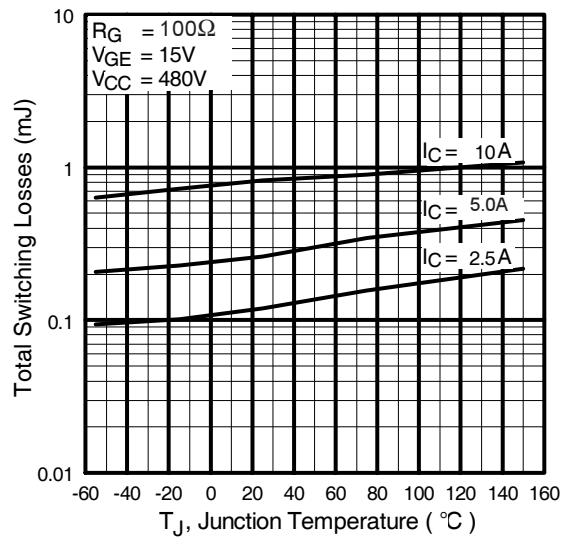

Fig. 10 - Typical Switching Losses vs. Junction Temperature

IRG4BC10UDPbF

International
IR Rectifier

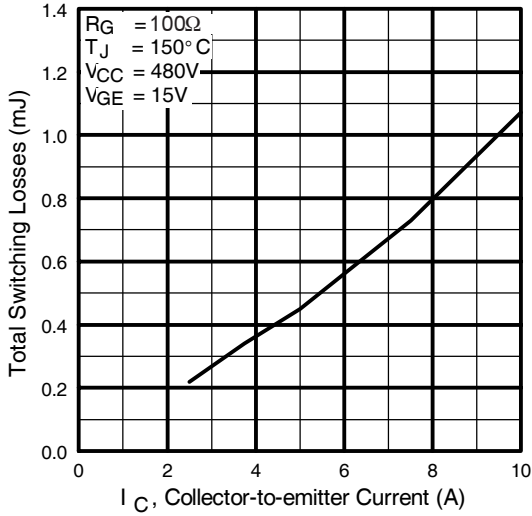

Fig. 11 - Typical Switching Losses vs. Collector-to-Emitter Current

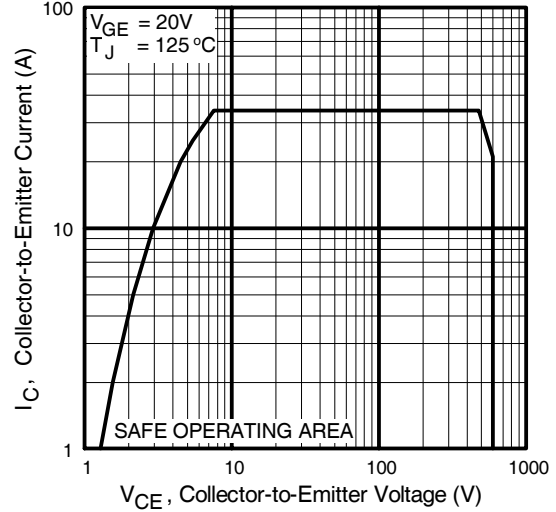

Fig. 12 - Turn-Off SOA

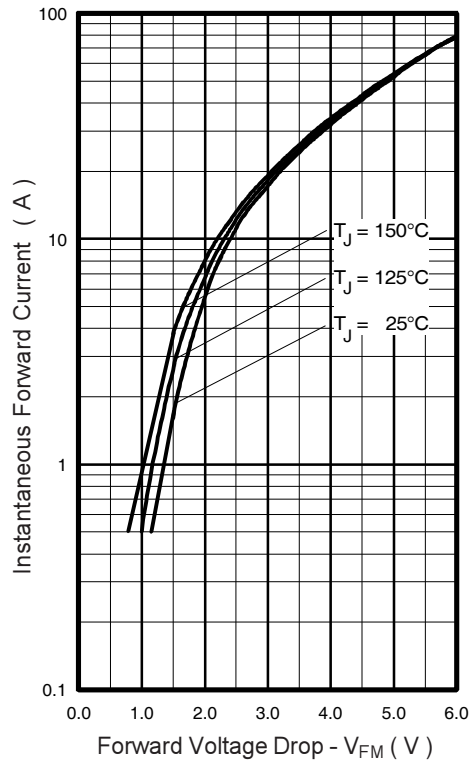

Fig. 13 - Maximum Forward Voltage Drop vs. Instantaneous Forward Current

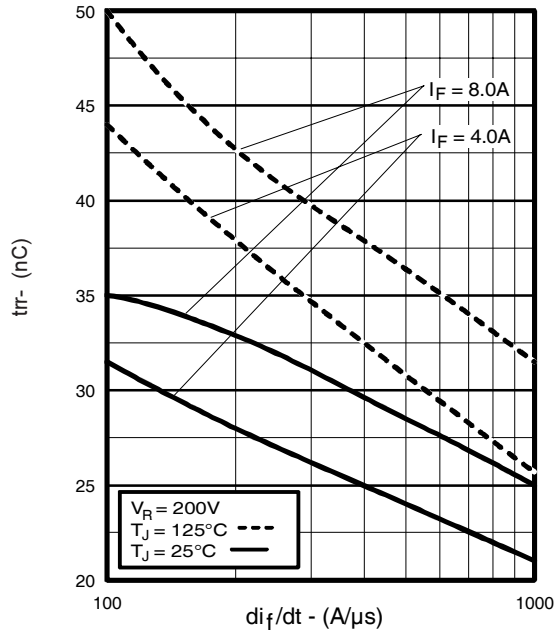

Fig. 14 - Typical Reverse Recovery vs. di_f/dt

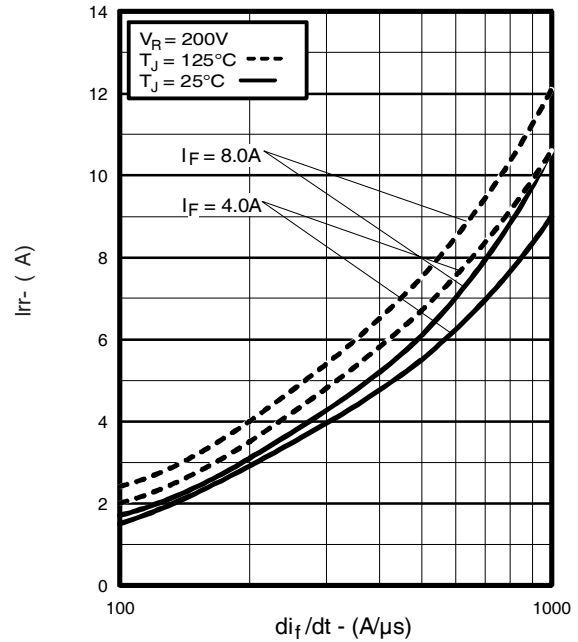

Fig. 15 - Typical Recovery Current vs. di_f/dt

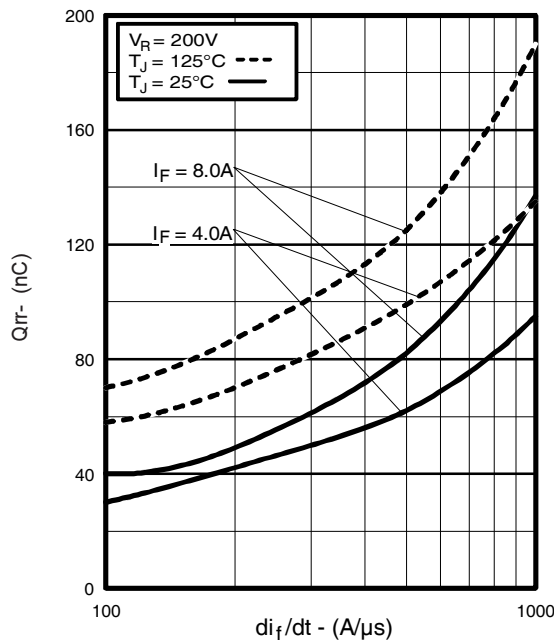

Fig. 16 - Typical Stored Charge vs. di_f/dt

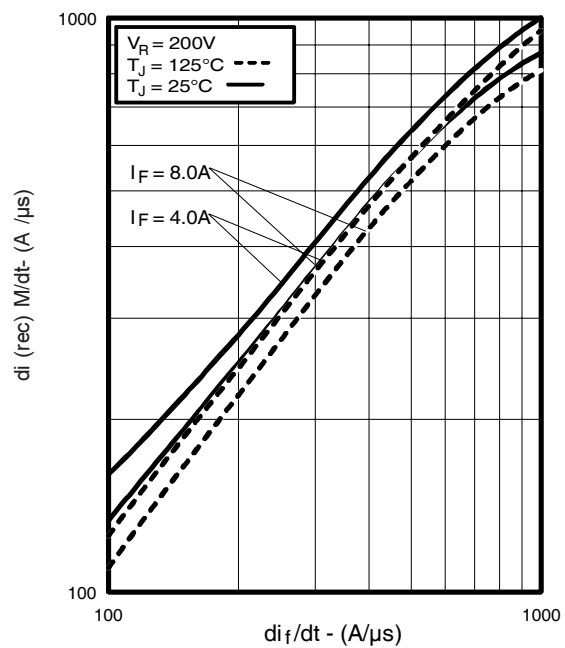

Fig. 17 - Typical $di_{(rec)M}/dt$ vs. di_f/dt ,

IRG4BC10UDPbF

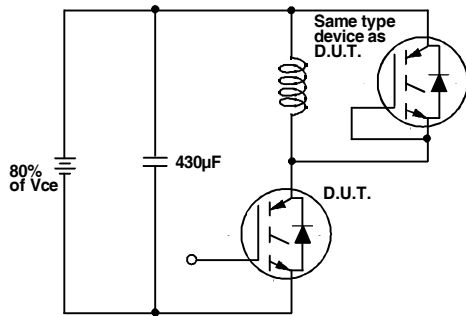

Fig. 18a - Test Circuit for Measurement of I_{LM} , E_{on} , $E_{off}(\text{diode})$, t_{rr} , Q_{rr} , I_{rr} , $t_{d(on)}$, t_r , $t_{d(off)}$, t_f

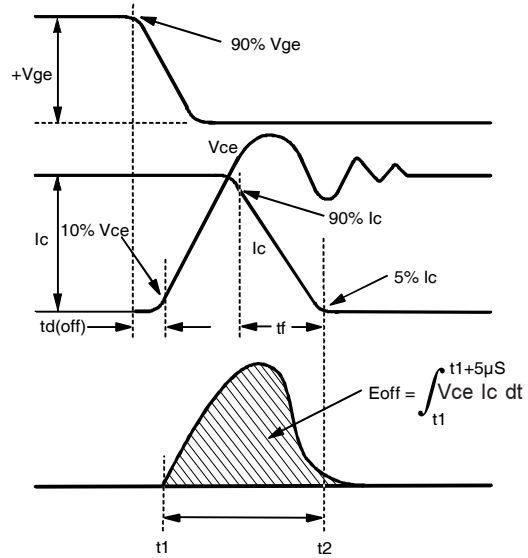

Fig. 18b - Test Waveforms for Circuit of Fig. 18a, Defining E_{off} , $t_{d(off)}$, t_f

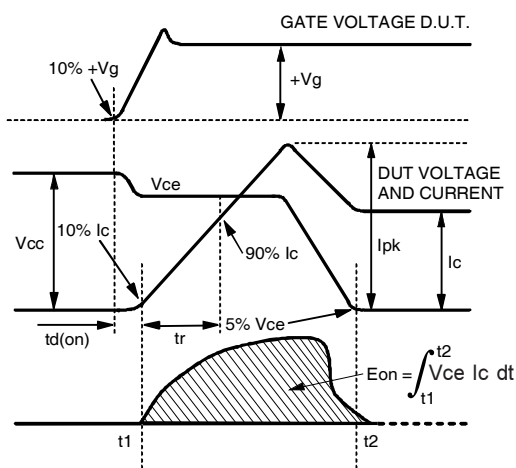

Fig. 18c - Test Waveforms for Circuit of Fig. 18a, Defining E_{on} , $t_{d(on)}$, t_r

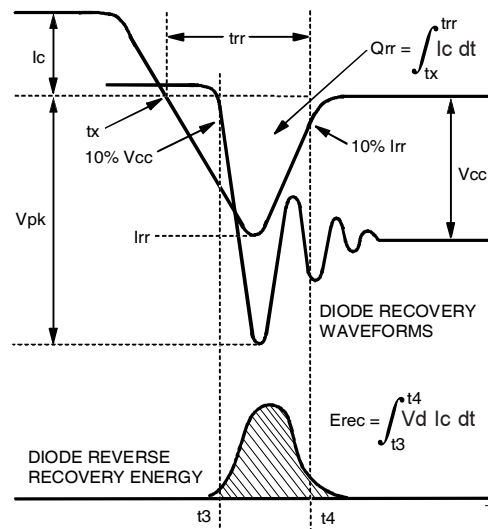

Fig. 18d - Test Waveforms for Circuit of Fig. 18a, Defining E_{rec} , t_{rr} , Q_{rr} , I_{rr}

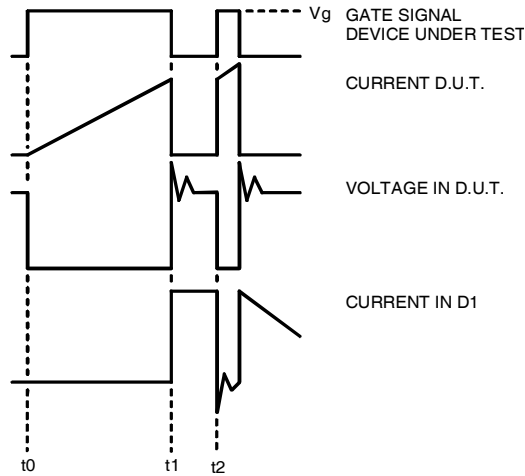

Figure 18e. Macro Waveforms for Figure 18a's Test Circuit

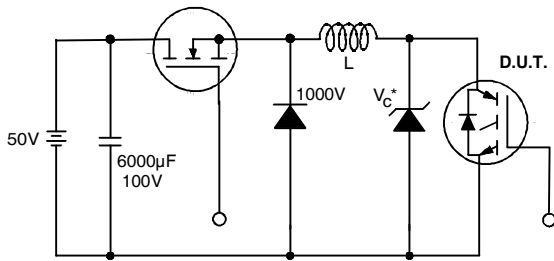

Figure 19. Clamped Inductive Load Test Circuit

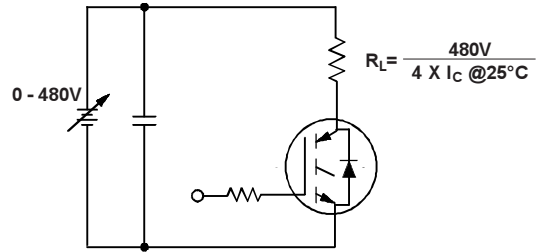

Figure 20. Pulsed Collector Current Test Circuit

IRG4BC10UDPbF

Notes:

- ① Repetitive rating: $V_{GE}=20V$; pulse width limited by maximum junction temperature (figure 20)
- ② $V_{CC}=80\%(V_{CES})$, $V_{GE}=20V$, $L=10\mu H$, $R_G = 100\Omega$ (figure 19)
- ③ Pulse width $\leq 80\mu s$; duty factor $\leq 0.1\%$.
- ④ Pulse width $5.0\mu s$, single shot.

TO-220AB Package Outline

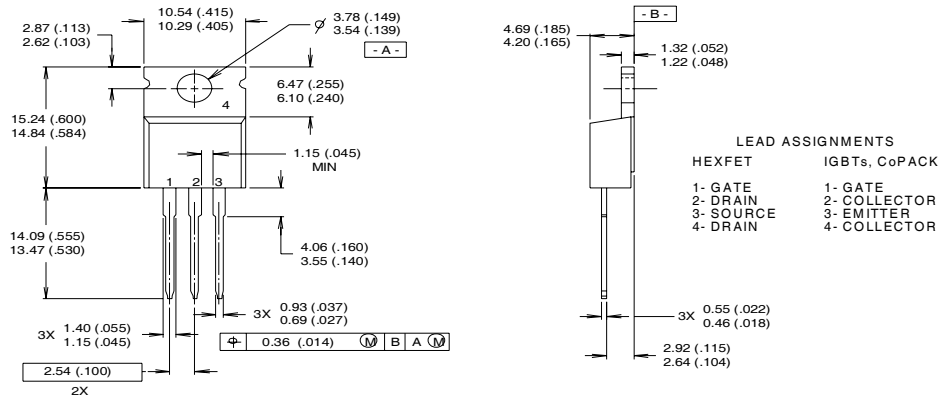

- NOTES:
- 1 DIMENSIONING & TOLERANCING PER ANSI Y14.5M, 1982.
 - 2 CONTROLLING DIMENSION : INCH
 - 3 OUTLINE CONFORMS TO JEDEC OUTLINE TO-220AB.
 - 4 HEATSINK & LEAD MEASUREMENTS DO NOT INCLUDE BURRS.

TO-220AB Part Marking Information

EXAMPLE: THIS IS AN IRF1010
 LOT CODE 1789
 ASSEMBLED ON WW 19, 1997
 IN THE ASSEMBLY LINE "C"
Note: "P" in assembly line
 position indicates "Lead-Free"

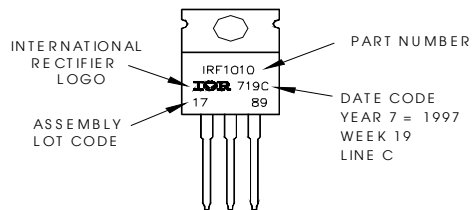

Note: For the most current drawings please refer to the IR website at:
<http://www.irf.com/package/>