

# High Voltage BIMOSFET™

## Monolithic Bipolar MOS Transistor

N-Channel, Enhancement Mode

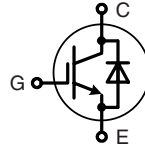

$$I_{C25} = 33 \text{ A}$$

$$V_{CES} = 1600 \text{ V}$$

$$V_{CE(sat)} = 6.2 \text{ V typ.}$$

$$t_{fi} = 40 \text{ ns}$$

TO-247 AD

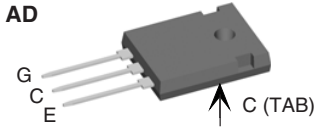

G = Gate,  
E = Emitter,      C = Collector,  
TAB = Collector

Symbol	Conditions	Maximum Ratings	
$V_{CES}$	$T_J = 25^\circ\text{C}$ to $150^\circ\text{C}$	1600	V
$V_{CGR}$	$T_J = 25^\circ\text{C}$ to $150^\circ\text{C}$ ; $R_{GE} = 1 \text{ M}\Omega$	1600	V
$V_{GES}$	Continuous	$\pm 20$	V
$V_{GEM}$	Transient	$\pm 30$	V
$I_{C25}$	$T_C = 25^\circ\text{C}$	33	A
$I_{C90}$	$T_C = 90^\circ\text{C}$	20	A
$I_{CM}$	$T_C = 25^\circ\text{C}$ , 1 ms	40	A
<b>SSOA (RBSOA)</b>	$V_{GE} = 15 \text{ V}$ , $T_{VJ} = 125^\circ\text{C}$ , $R_G = 22 \Omega$ , $V_{CE} = 0.8 \cdot V_{CES}$ Clamped inductive load, $L = 100 \mu\text{H}$	$I_{CM} = 40$	A
$P_C$	$T_C = 25^\circ\text{C}$	350	W
$T_J$		-55 ... +150	$^\circ\text{C}$
$T_{JM}$		150	$^\circ\text{C}$
$T_{stg}$		-55 ... +150	$^\circ\text{C}$
$T_L$	1.6 mm (0.063 in) from case for 10 s	300	$^\circ\text{C}$
$M_d$	Mounting torque	1.15/10Nm/lb.in.	
<b>Weight</b>		6	g

### Features

- International standard package JEDEC TO-247 AD
- High Voltage BIMOSFET™
  - replaces high voltage Darlington's and series connected MOSFET's
  - lower effective  $R_{DS(on)}$
- Monolithic construction
  - high blocking voltage capability
  - very fast turn-off characteristics
- MOS Gate turn-on
  - drive simplicity
- Intrinsic diode

### Applications

- AC motor speed control
- DC servo and robot drives
- DC choppers
- Uninterruptible power supplies (UPS)
- Switched-mode and resonant-mode power supplies
- CRT deflection
- Lamp ballasts

### Advantages

- Easy to mount with 1 screw (isolated mounting screw hole)
- Space savings
- High power density

Symbol	Conditions	Characteristic Values ( $T_J = 25^\circ\text{C}$ , unless otherwise specified)		
		min.	typ.	max.
$BV_{CES}$	$I_C = 1 \text{ mA}$ , $V_{GE} = 0 \text{ V}$	1600		V
$V_{GE(th)}$	$I_C = 2 \text{ mA}$ , $V_{CE} = V_{GE}$	4		8 V
$I_{CES}$	$V_{CE} = 0.8 \cdot V_{CES}$ $V_{GE} = 0 \text{ V}$		$T_J = 25^\circ\text{C}$ $T_J = 125^\circ\text{C}$	400 $\mu\text{A}$ 3 mA
$I_{GES}$	$V_{CE} = 0 \text{ V}$ , $V_{GE} = \pm 20 \text{ V}$			$\pm 500 \text{ nA}$
$V_{CE(sat)}$	$I_C = I_{C90}$ , $V_{GE} = 15 \text{ V}$		$T_J = 125^\circ\text{C}$	6.2    7.1 V 7.8 V

Symbol	Conditions	Characteristic Values		
		(T <sub>J</sub> = 25°C, unless otherwise specified)		
		min.	typ.	max.
C <sub>ies</sub> C <sub>oes</sub> C <sub>res</sub>	V <sub>CE</sub> = 25 V, V <sub>GE</sub> = 0 V, f = 1 MHz		3300	pF
			220	pF
			30	pF
Q <sub>g</sub>	I <sub>C</sub> = 20 A, V <sub>CE</sub> = 600 V, V <sub>GE</sub> = 15 V		130	nC
t <sub>d(on)</sub> t <sub>ri</sub> t <sub>d(off)</sub> t <sub>fi</sub>	<b>Inductive load, T<sub>J</sub> = 125°C</b> I <sub>C</sub> = I <sub>C90</sub> , V <sub>GE</sub> = 15 V, L = 100 μH, V <sub>CE</sub> = 960 V, R <sub>G</sub> = 22 Ω		200	ns
			60	ns
			270	ns
			40	ns
R <sub>thJC</sub> R <sub>thCK</sub>			0.25	0.35 K/W K/W

Symbol	Conditions	Characteristic Values		
		(T <sub>J</sub> = 25°C, unless otherwise specified)		
		min.	typ.	max.
V <sub>F</sub>	I <sub>F</sub> = I <sub>C90</sub> , V <sub>GE</sub> = 0 V, Pulse test t ≤ 300 μs, duty cycle d ≤ 2%		2.5	5 V

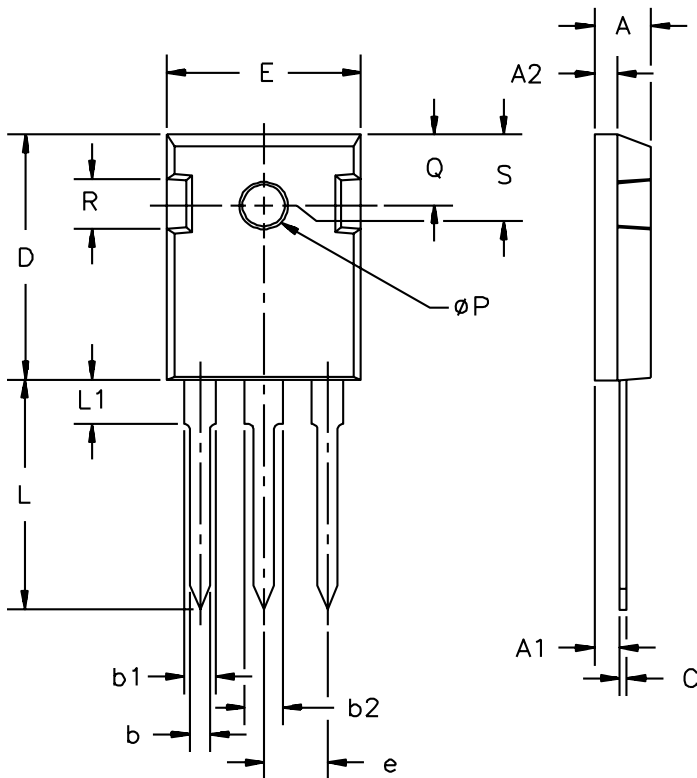
**TO-247 AD Outline**

Dim.	Millimeter		Inches	
	Min.	Max.	Min.	Max.
A	19.81	20.32	0.780	0.800
B	20.80	21.46	0.819	0.845
C	15.75	16.26	0.610	0.640
D	3.55	3.65	0.140	0.144
E	4.32	5.49	0.170	0.216
F	5.4	6.2	0.212	0.244
G	1.65	2.13	0.065	0.084
H	-	4.5	-	0.177
J	1.0	1.4	0.040	0.055
K	10.8	11.0	0.426	0.433
L	4.7	5.3	0.185	0.209
M	0.4	0.8	0.016	0.031
N	1.5	2.49	0.087	0.102

IXYS reserves the right to change limits, test conditions and dimensions.

© 2006 IXYS All rights reserved

0648

2 - 4

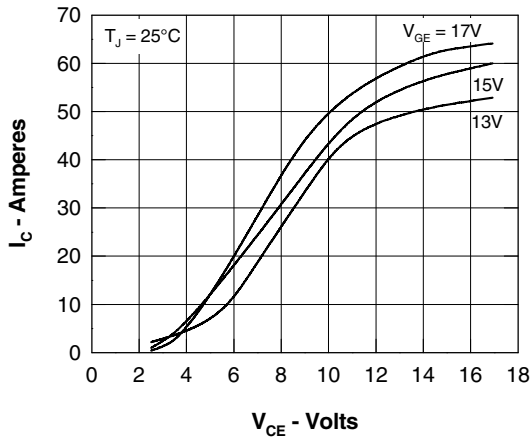

Fig. 1 Typ. Output Characteristics

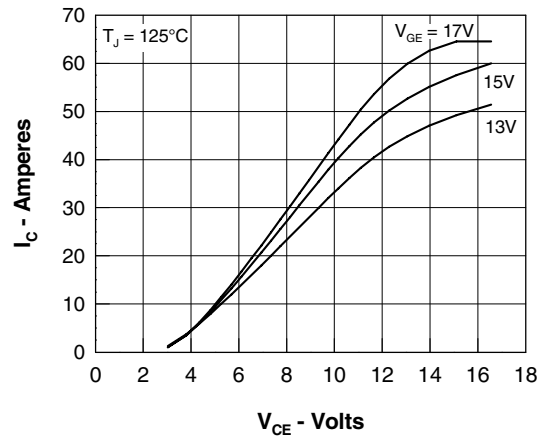

Fig. 2 Typ. Output Characteristics

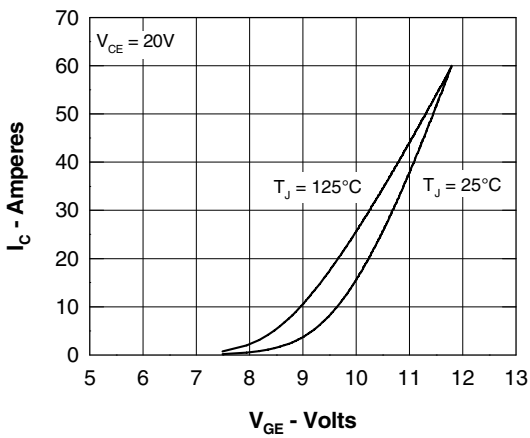

Fig. 3 Typ. Transfer Characteristics

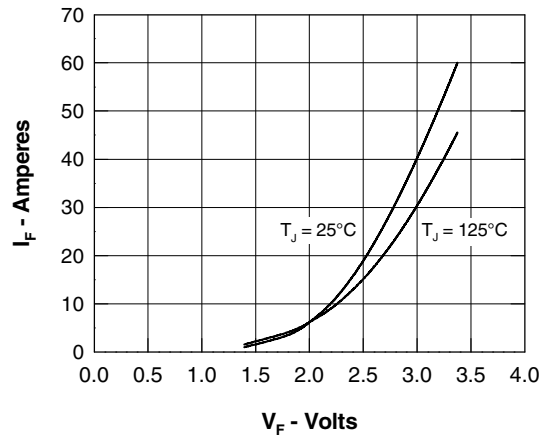

Fig. 4 Typ. Characteristics of Reverse Conduction

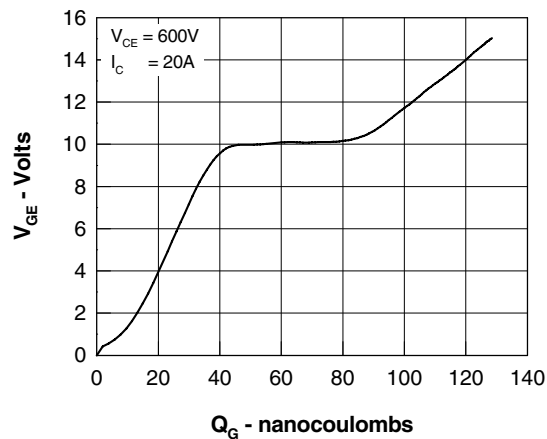

Fig. 5 Typ. Gate Charge characteristics

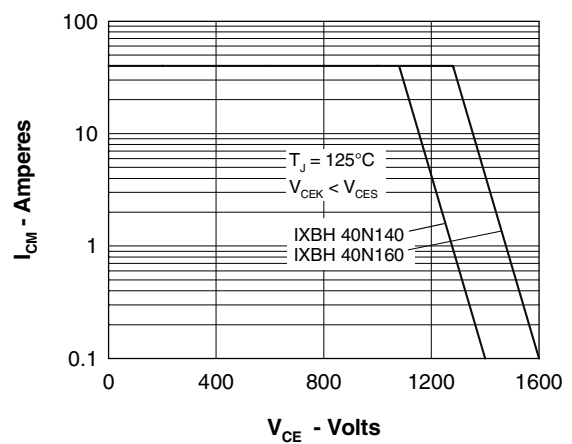

Fig. 6 Reverse Based Safe Operating Area RBSOA

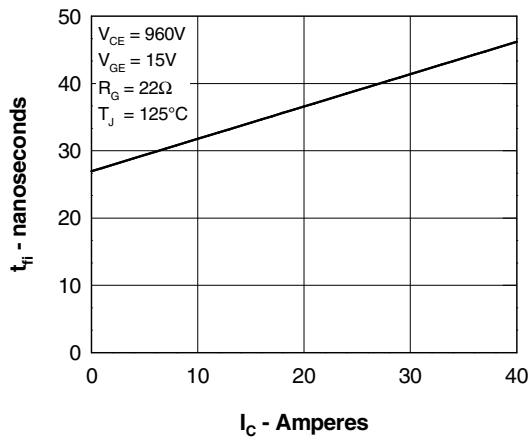

Fig. 7 Typ. Fall Time

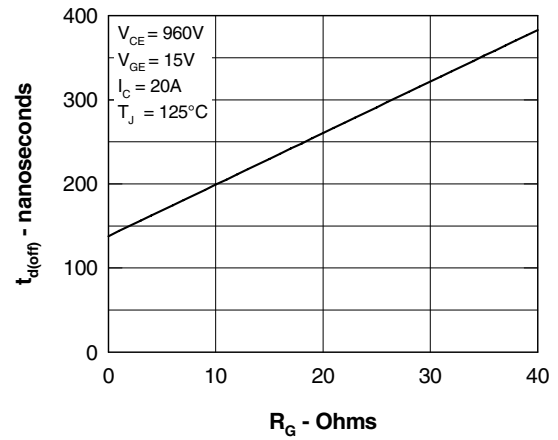

Fig. 8 Typ. Turn Off Delay Time

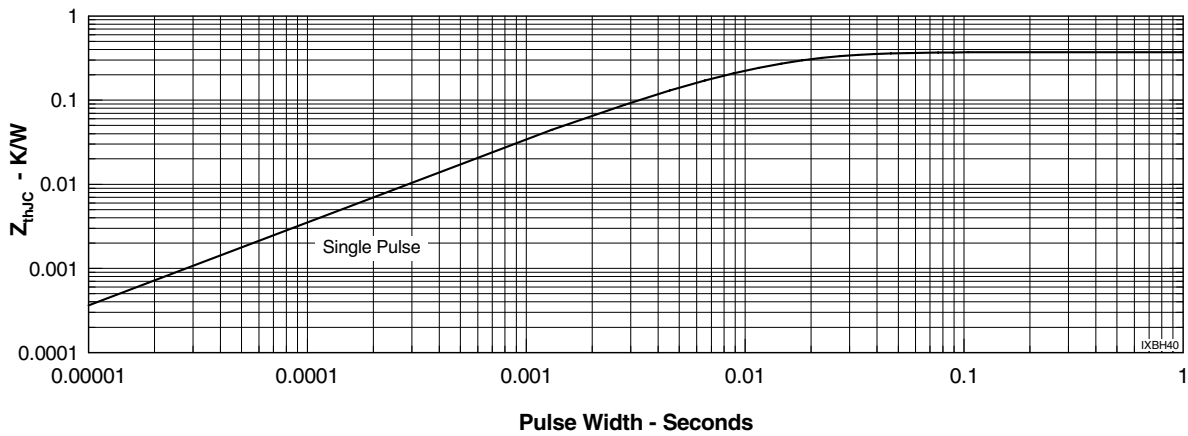

Fig. 9 Typ. Transient Thermal Impedance