

High Speed IGBT with Diode

IXSH 30N60B2D1 IXST 30N60B2D1

$V_{CES} = 600 \text{ V}$
 $I_{C25} = 48 \text{ A}$
 $V_{CE(sat)} = 2.5 \text{ V}$

Short Circuit SOA Capability

Preliminary Data Sheet

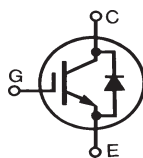

Symbol	Test Conditions	Maximum Ratings	
V_{CES}	$T_J = 25^\circ\text{C}$ to 150°C	600	V
V_{CGR}	$T_J = 25^\circ\text{C}$ to 150°C ; $R_{GE} = 1 \text{ M}\Omega$	600	V
V_{GES}	Continuous	± 20	V
V_{GEM}	Transient	± 30	V
I_{C25}	$T_C = 25^\circ\text{C}$	48	A
I_{C110}	$T_C = 110^\circ\text{C}$	30	A
$I_{F(110)}$		28	A
I_{CM}	$T_C = 25^\circ\text{C}$, 1 ms	90	A
SSOA (RBSOA)	$V_{GE} = 15 \text{ V}$, $T_J = 125^\circ\text{C}$, $R_G = 10 \Omega$ Clamped inductive load	$I_{CM} = 48$ @ $0.8 V_{CES}$	A
t_{SC} (SCSOA)	$V_{GE} = 15 \text{ V}$, $V_{CE} = 360 \text{ V}$, $T_J = 125^\circ\text{C}$ $R_G = 10 \Omega$, non repetitive	10	μs
P_c	$T_C = 25^\circ\text{C}$	250	W
T_J		-55 ... +150	$^\circ\text{C}$
T_{JM}		150	$^\circ\text{C}$
T_{stg}		-55 ... +150	$^\circ\text{C}$
Weight	TO-247	6	g
	TO-268	5	g
Maximum lead temperature for soldering 1.6 mm (0.062 in.) from case for 10 s		300	$^\circ\text{C}$
Maximum tab temperature for soldering for 10s		260	$^\circ\text{C}$

TO-247 (IXSH)

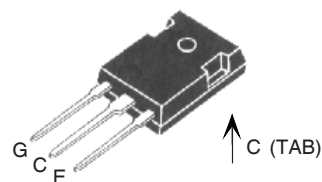

TO-268 (IXST)

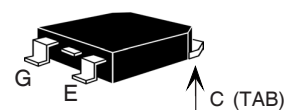

G = Gate C = Collector
 E = Emitter TAB = Collector

Features

- International standard package
- Guaranteed Short Circuit SOA capability
- Low $V_{CE(sat)}$
 - for low on-state conduction losses
- High current handling capability
- MOS Gate turn-on
 - drive simplicity
- Fast fall time for switching speeds up to 20 kHz

Applications

- AC motor speed control
- Uninterruptible power supplies (UPS)
- Welding

Advantages

- High power density

Symbol	Test Conditions	Characteristic Values ($T_J = 25^\circ\text{C}$, unless otherwise specified)		
		min.	typ.	max.
$V_{GE(th)}$	$I_C = 750 \mu\text{A}$, $V_{CE} = V_{GE}$	4.0		7.0 V
I_{CES}	$V_{CE} = V_{CES}$ $V_{GE} = 0 \text{ V}$			150 μA 1 mA
I_{GES}	$V_{CE} = 0 \text{ V}$, $V_{GE} = \pm 20 \text{ V}$			$\pm 100 \text{ nA}$
$V_{CE(sat)}$	$I_C = 24 \text{ A}$, $V_{GE} = 15 \text{ V}$			2.5 V

Symbol	Test Conditions	Characteristic Values ($T_J = 25^\circ\text{C}$, unless otherwise specified)		
		min.	typ.	max.
g_{fs}	$I_C = 24\text{A}; V_{CE} = 10\text{V}$, Note 1	7.0	12.0	S
C_{ies}	$V_{CE} = 25\text{V}, V_{GE} = 0\text{V}$ $f = 1\text{MHz}$ 20N60B2D1		1220	pF
C_{oes}			110	pF
			140	pF
C_{res}			42	pF
Q_g			50	nC
Q_{ge}	$I_C = 24\text{A}, V_{GE} = 15\text{V}, V_{CE} = 0.5 V_{CES}$		23	nC
Q_{gc}			15	nC
$t_{d(on)}$	Inductive load, $T_J = 25^\circ\text{C}$		30	ns
t_{ri}	$I_C = 24\text{A}, V_{GE} = 15\text{V}$		30	ns
$t_{d(off)}$	$V_{CE} = 400\text{V}, R_G = 5\ \Omega$		130	280 ns
t_{fi}	Switching times may increase for V_{CE} (Clamp) $> 0.8 \cdot V_{CES}$, higher T_J or increased R_G		140	300 ns
E_{off}		0.55	1.0	mJ
$t_{d(on)}$	Inductive load, $T_J = 125^\circ\text{C}$		30	ns
t_{ri}			50	ns
E_{on}		$I_C = 24\text{A}, V_{GE} = 15\text{V}$	0.32	mJ
	$V_{CE} = 400\text{V}, R_G = 5\ \Omega$	0.82	mJ	
$t_{d(off)}$	Switching times may increase for V_{CE} (Clamp) $> 0.8 \cdot V_{CES}$, higher T_J or increased R_G		202	ns
t_{fi}			234	ns
E_{off}		1.18	mJ	
R_{thJC}			0.50	K/W
R_{thCS}		0.21	K/W	

Symbol	Test Conditions	Characteristic Values ($T_J = 25^\circ\text{C}$, unless otherwise specified)		
		min.	typ.	max.
V_F	$I_F = 30\text{A}, V_{GE} = 0\text{V}$	$T_J = 150^\circ\text{C}$	1.6	V
			2.5	V
I_{RM}	$I_F = 50\text{A}, V_{GE} = 0\text{V}, -di_F/dt = 100\text{A}/\mu\text{s}$	$T_J = 100^\circ\text{C}$	2.0	A
t_{rr}	$V_R = 100\text{V}$	$T_J = 100^\circ\text{C}$	150	ns
t_{rr}	$I_F = 1\text{A}; -di/dt = 100\text{A}/\mu\text{s}; V_R = 30\text{V}$		30	ns
R_{thJC}			0.9	K/W

Note 1: Pulse test, $t \leq 300\ \mu\text{s}$, duty cycle $d \leq 2\%$

TO-247 (IXSH) Outline

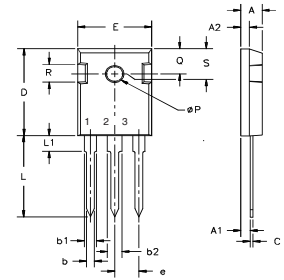

Terminals: 1 - Gate 2 - Drain

Dim.	Millimeter		Inches	
	Min.	Max.	Min.	Max.
A	4.7	5.3	.185	.209
A ₁	2.2	2.54	.087	.102
A ₂	2.2	2.6	.059	.098
b	1.0	1.4	.040	.055
b ₁	1.65	2.13	.065	.084
b ₂	2.87	3.12	.113	.123
C	.4	.8	.016	.031
D	20.80	21.46	.819	.845
E	15.75	16.26	.610	.640
e	5.20	5.72	0.205	0.225
L	19.81	20.32	.780	.800
L1		4.50		.177
∅P	3.55	3.65	.140	.144
Q	5.89	6.40	0.232	0.252

TO-268 (IXST) Outline

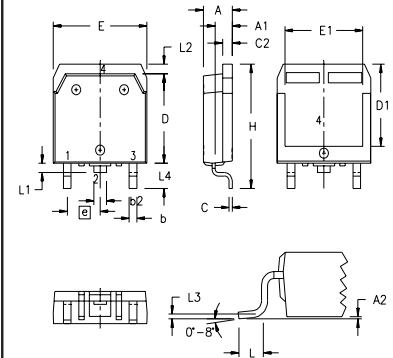

SYM	INCHES		MILLIMETERS	
	MIN	MAX	MIN	MAX
A	.193	.201	4.90	5.10
A1	.106	.114	2.70	2.90
A2	.001	.010	0.02	0.25
b	.045	.057	1.15	1.45
b2	.075	.083	1.90	2.10
C	.016	.026	0.40	0.65
C2	.057	.063	1.45	1.60
D	.543	.551	13.80	14.00
D1	.488	.500	12.40	12.70
E	.624	.632	15.85	16.05
E1	.524	.535	13.30	13.60
e	.215 BSC		5.45 BSC	
H	.736	.752	18.70	19.10
L	.094	.106	2.40	2.70
L1	.047	.055	1.20	1.40
L2	.039	.045	1.00	1.15
L3	.010 BSC		0.25 BSC	
L4	.150	.161	3.80	4.10

**Fig. 1. Output Characteristics
@ 25 °C**

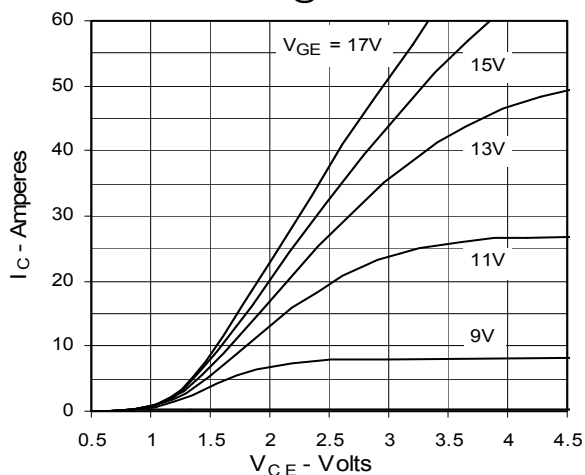

**Fig. 2. Extended Output Characteristics
@ 25 °C**

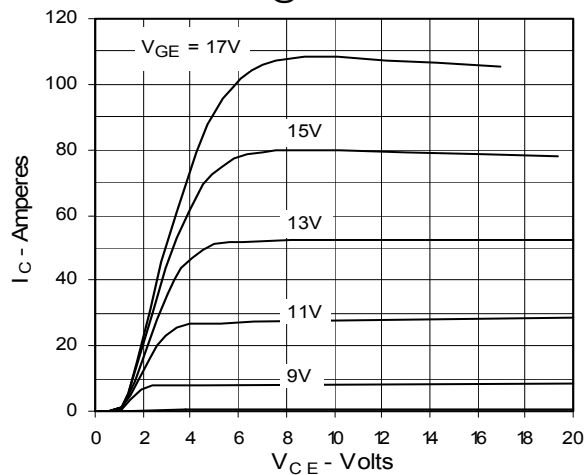

**Fig. 3. Output Characteristics
@ 125 °C**

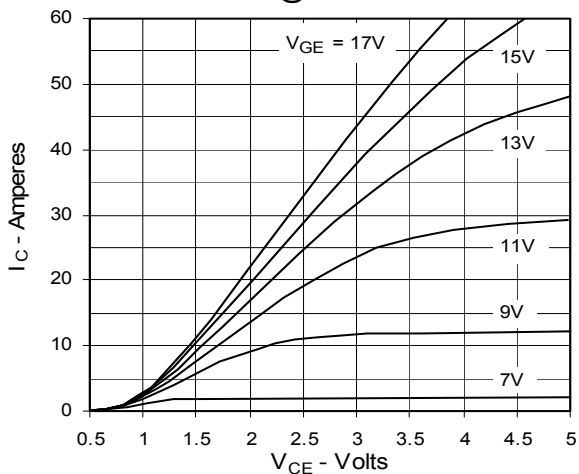

**Fig. 4. Dependence of $V_{CE(sat)}$ on
Temperature**

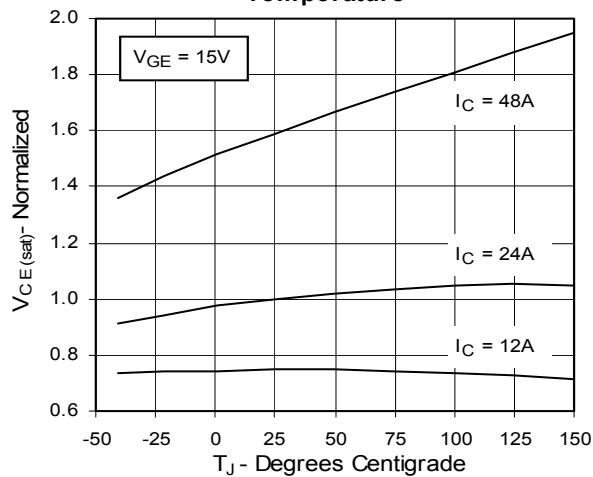

**Fig. 5. Collector-to-Emitter Voltage
vs. Gate-to-Emitter voltage**

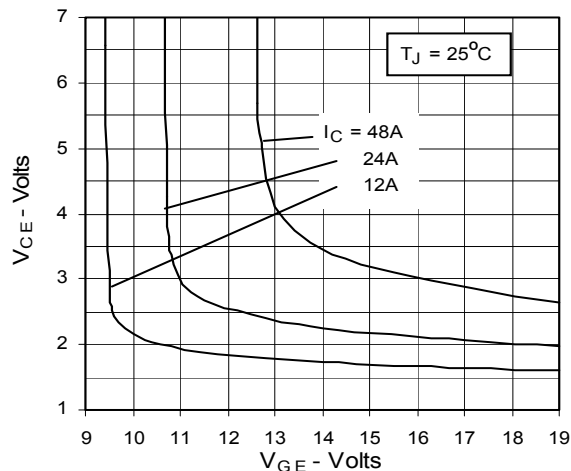

Fig. 6. Input Admittance

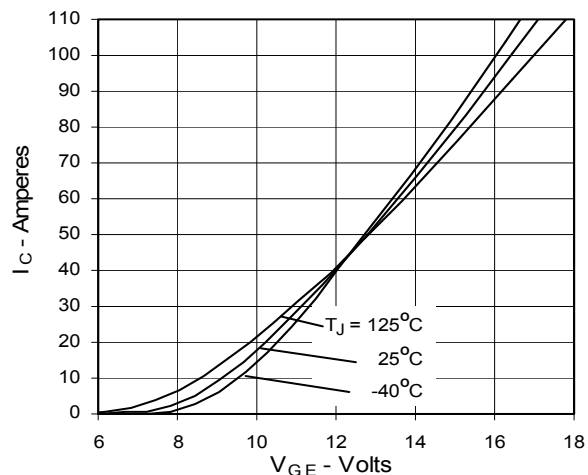

Fig. 7. Transconductance

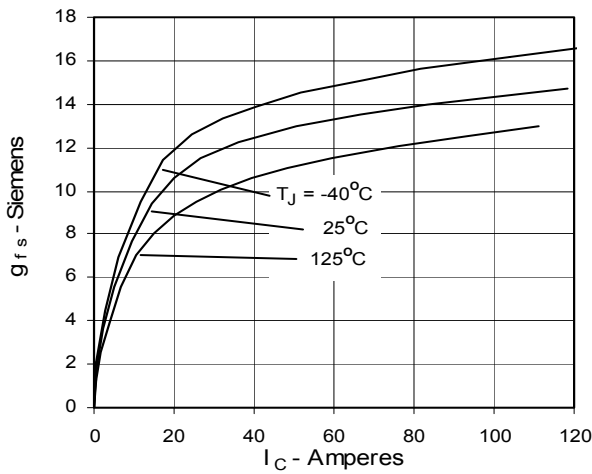

Fig. 8. Dependence of Turn-off Energy Loss on R_G

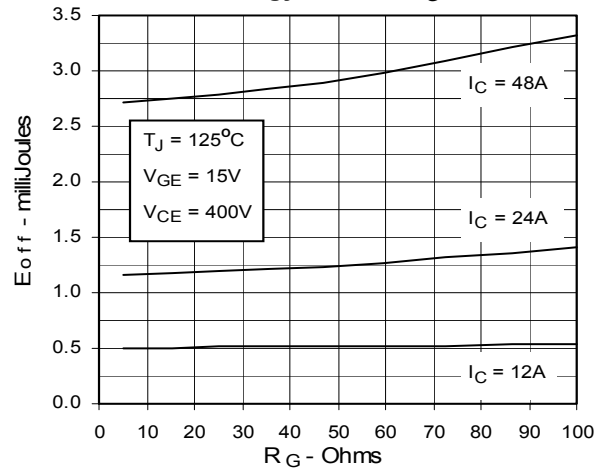

Fig. 9. Dependence of Turn-Off Energy Loss on I_C

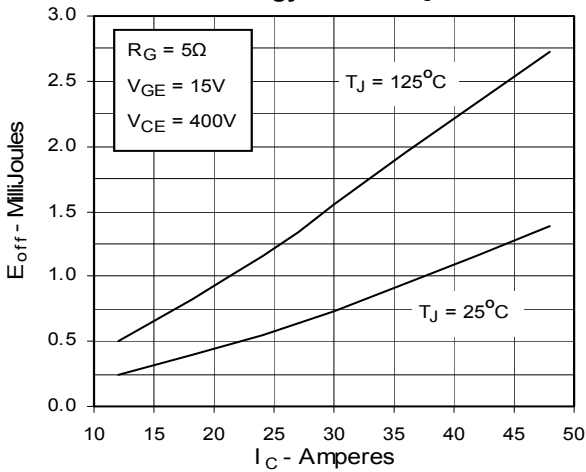

Fig. 10. Dependence of Turn-off Energy Loss on Temperature

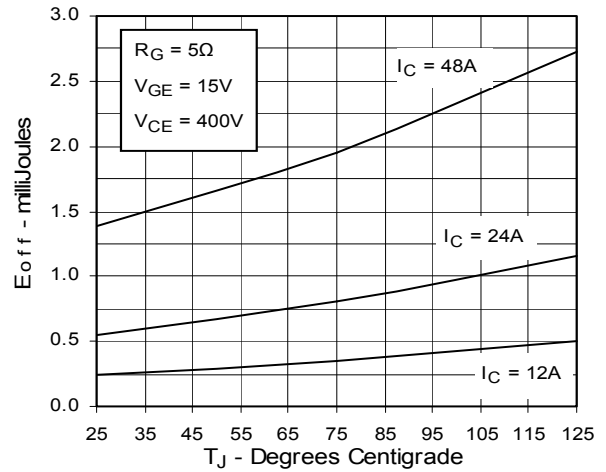

Fig. 11. Dependence of Turn-off Switching Time on R_G

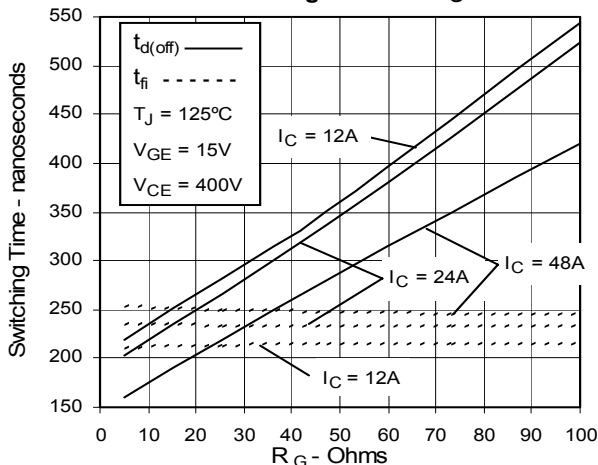

Fig. 12. Dependence of Turn-off Switching Time on I_C

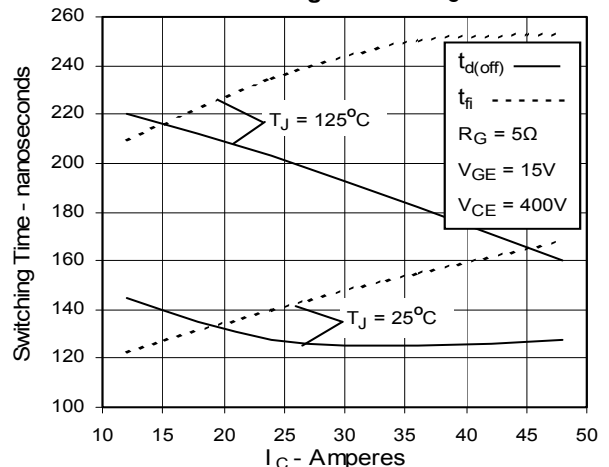

Fig. 13. Dependence of Turn-off Switching Time on Temperature

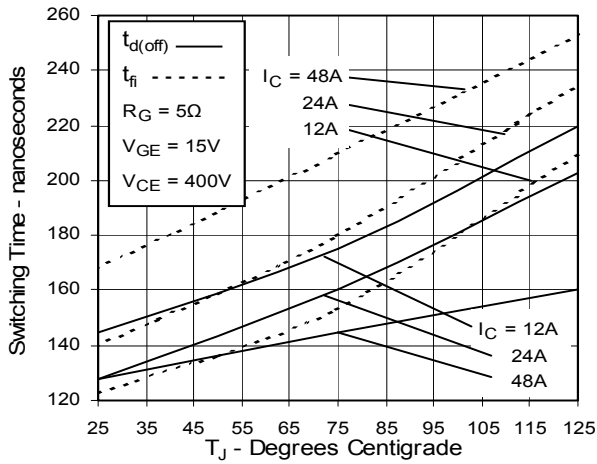

Fig. 14. Gate Charge

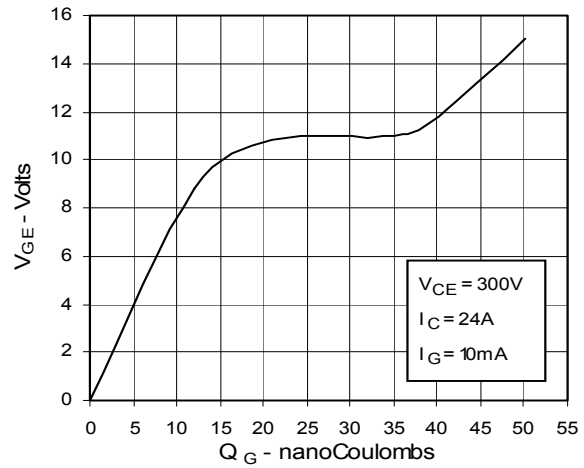

Fig. 15. Capacitance

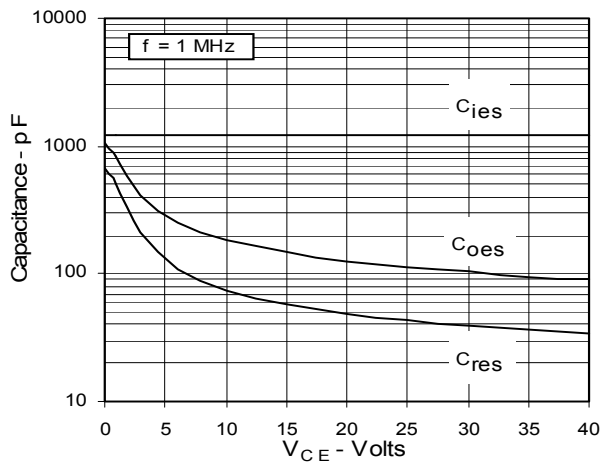

Fig. 16. Reverse-Bias Safe Operating Area

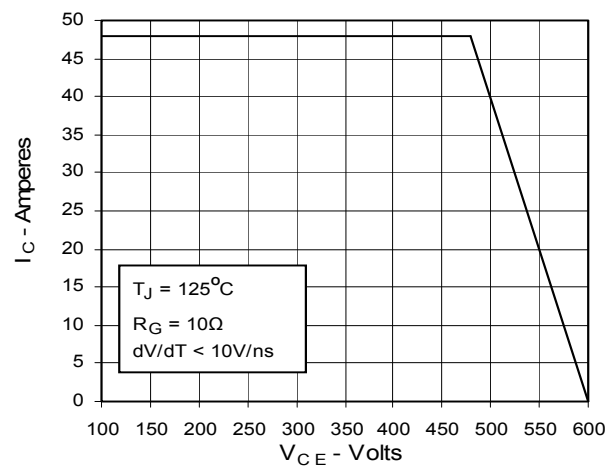
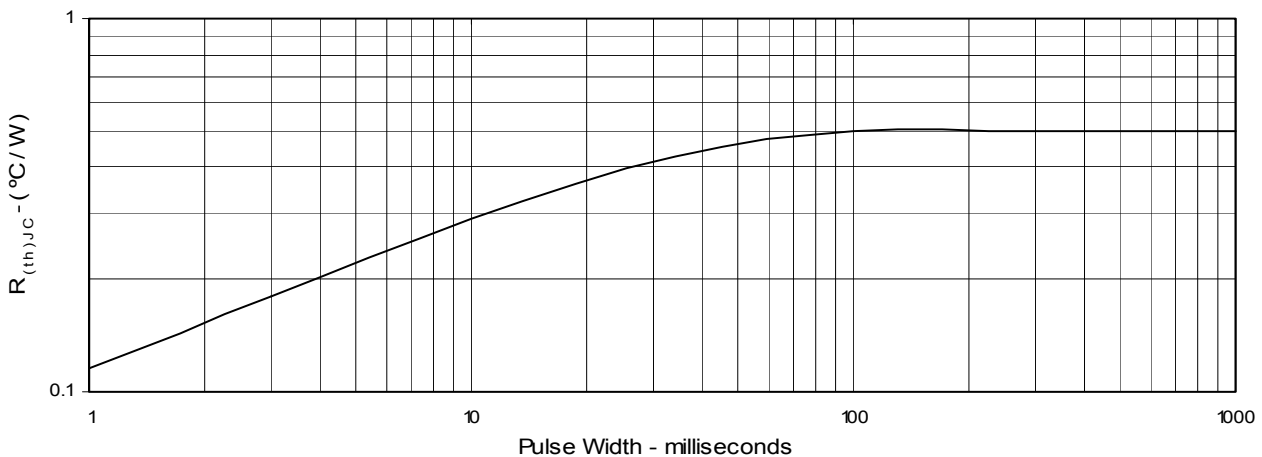

Fig. 17. Maximum Transient Thermal Resistance



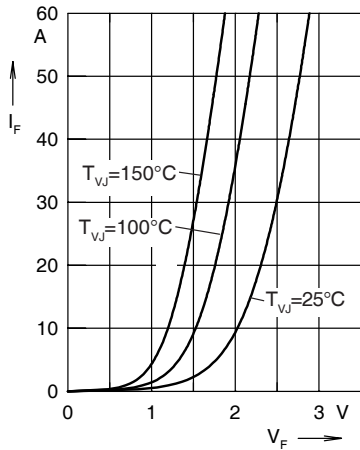

Fig. 18. Forward current I_F versus V_F

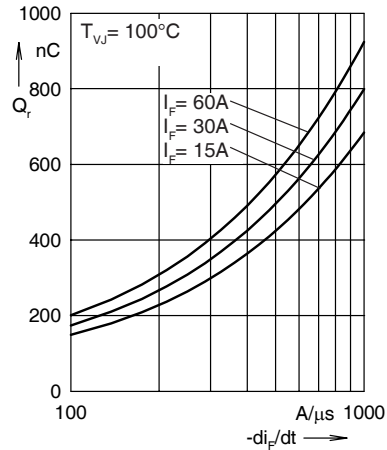

Fig. 19. Reverse recovery charge

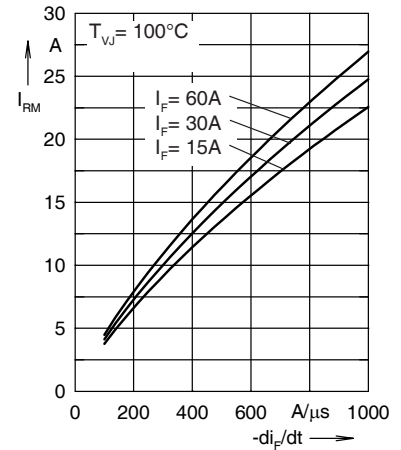

Fig. 20. Peak reverse current I_{RM}

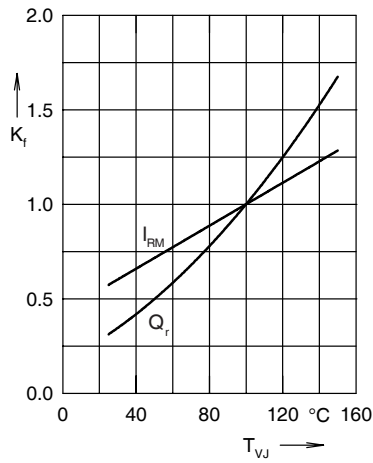

Fig. 21. Dynamic parameters Q_r , I_{RM}

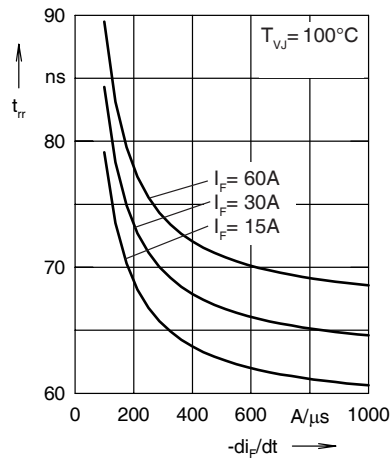

Fig. 22. Recovery time t_{tr} versus

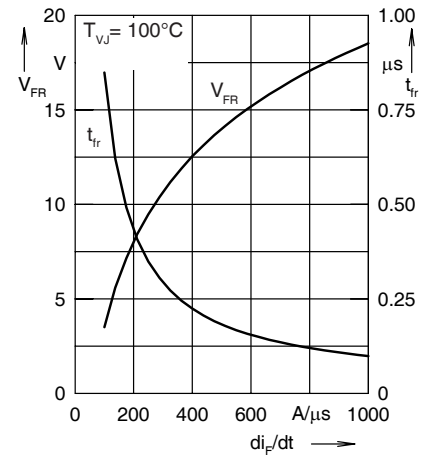

Fig. 23. Peak forward voltage V_{FR}

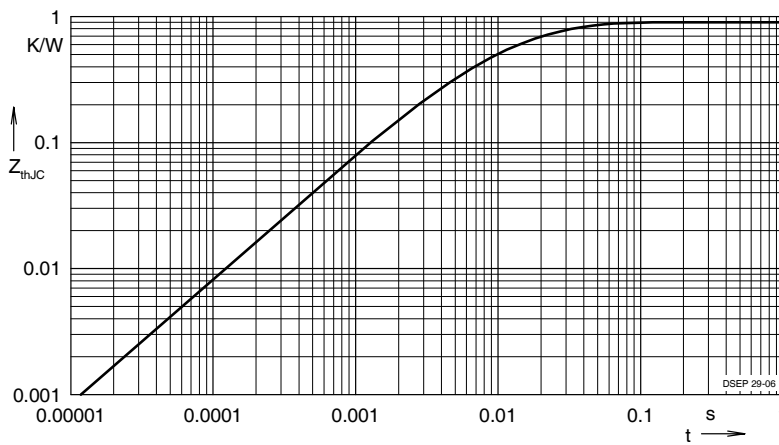

Fig. 24. Transient thermal resistance junction to case

Constants for Z_{thjC} calculation:

i	R_{thi} (K/W)	t_i (s)
1	0.502	0.0052
2	0.193	0.0003