



# FGA25N120ANTD/FGA25N120ANTD\_F109 1200V NPT Trench IGBT

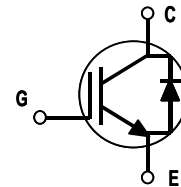
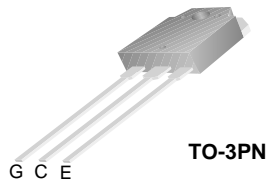
## Features

- NPT Trench Technology, Positive temperature coefficient
- Low saturation voltage:  $V_{CE(sat), typ} = 2.0V$   
@  $I_C = 25A$  and  $T_C = 25^\circ C$
- Low switching loss:  $E_{off, typ} = 0.96mJ$   
@  $I_C = 25A$  and  $T_C = 25^\circ C$
- Extremely enhanced avalanche capability

## Description

Using Fairchild's proprietary trench design and advanced NPT technology, the 1200V NPT IGBT offers superior conduction and switching performances, high avalanche ruggedness and easy parallel operation.

This device is well suited for the resonant or soft switching application such as induction heating, microwave oven, etc.



## Absolute Maximum Ratings

Symbol	Description	FGA25N120ANTD	Units
$V_{CES}$	Collector-Emitter Voltage	1200	V
$V_{GES}$	Gate-Emitter Voltage	$\pm 20$	V
$I_C$	Collector Current	@ $T_C = 25^\circ C$	50
	Collector Current	@ $T_C = 100^\circ C$	25
$I_{CM}$	Pulsed Collector Current (Note 1)	90	A
$I_F$	Diode Continuous Forward Current	@ $T_C = 100^\circ C$	25
$I_{FM}$	Diode Maximum Forward Current	150	A
$P_D$	Maximum Power Dissipation	@ $T_C = 25^\circ C$	312
	Maximum Power Dissipation	@ $T_C = 100^\circ C$	125
$T_J$	Operating Junction Temperature	-55 to +150	$^\circ C$
$T_{stg}$	Storage Temperature Range	-55 to +150	$^\circ C$
$T_L$	Maximum Lead Temp. for soldering Purposes, 1/8" from case for 5 seconds	300	$^\circ C$

## Thermal Characteristics

Symbol	Parameter	Typ.	Max.	Units
$R_{\theta JC}$	Thermal Resistance, Junction-to-Case for IGBT	--	0.4	$^\circ C/W$
$R_{\theta JC}$	Thermal Resistance, Junction-to-Case for Diode	--	2.0	$^\circ C/W$
$R_{\theta JA}$	Thermal Resistance, Junction-to-Ambient	--	40	$^\circ C/W$

## Package Marking and Ordering Information

Device Marking	Device	Package	Reel Size	Tape Width	Quantity
FGA25N120ANTD	FGA25N120ANTD	TO-3P	--	--	30

## Electrical Characteristics of the IGBT T<sub>C</sub> = 25°C unless otherwise noted

Symbol	Parameter	Test Conditions	Min.	Typ.	Max.	Units
<b>Off Characteristics</b>						
I <sub>CES</sub>	Collector Cut-Off Current	V <sub>CE</sub> = V <sub>CES</sub> , V <sub>GE</sub> = 0V	--	--	3	mA
I <sub>GES</sub>	G-E Leakage Current	V <sub>GE</sub> = V <sub>GES</sub> , V <sub>CE</sub> = 0V	--	--	± 250	nA
<b>On Characteristics</b>						
V <sub>GE(th)</sub>	G-E Threshold Voltage	I <sub>C</sub> = 25mA, V <sub>CE</sub> = V <sub>GE</sub>	3.5	5.5	7.5	V
V <sub>CE(sat)</sub>	Collector to Emitter Saturation Voltage	I <sub>C</sub> = 25A, V <sub>GE</sub> = 15V	--	2.0	2.5	V
		I <sub>C</sub> = 25A, V <sub>GE</sub> = 15V, T <sub>C</sub> = 125°C	--	2.15	--	V
		I <sub>C</sub> = 50A, V <sub>GE</sub> = 15V	--	2.65	--	V
<b>Dynamic Characteristics</b>						
C <sub>ies</sub>	Input Capacitance	V <sub>CE</sub> = 30V, V <sub>GE</sub> = 0V, f = 1MHz	--	3700	--	pF
C <sub>oes</sub>	Output Capacitance		--	130	--	pF
C <sub>res</sub>	Reverse Transfer Capacitance		--	80	--	pF
<b>Switching Characteristics</b>						
t <sub>d(on)</sub>	Turn-On Delay Time	V <sub>CC</sub> = 600 V, I <sub>C</sub> = 25A, R <sub>G</sub> = 10Ω, V <sub>GE</sub> = 15V, Inductive Load, T <sub>C</sub> = 25°C	--	50	--	ns
t <sub>r</sub>	Rise Time		--	60	90	ns
t <sub>d(off)</sub>	Turn-Off Delay Time		--	190	--	ns
t <sub>f</sub>	Fall Time		--	100	180	ns
E <sub>on</sub>	Turn-On Switching Loss		--	4.1	6.2	mJ
E <sub>off</sub>	Turn-Off Switching Loss		--	0.96	1.5	mJ
E <sub>ts</sub>	Total Switching Loss		--	5.06	7.7	mJ
t <sub>d(on)</sub>	Turn-On Delay Time	V <sub>CC</sub> = 600 V, I <sub>C</sub> = 25A, R <sub>G</sub> = 10Ω, V <sub>GE</sub> = 15V, Inductive Load, T <sub>C</sub> = 125°C	--	50	--	ns
t <sub>r</sub>	Rise Time		--	60	--	ns
t <sub>d(off)</sub>	Turn-Off Delay Time		--	200	--	ns
t <sub>f</sub>	Fall Time		--	154	--	ns
E <sub>on</sub>	Turn-On Switching Loss		--	4.3	6.9	mJ
E <sub>off</sub>	Turn-Off Switching Loss		--	1.5	2.4	mJ
E <sub>ts</sub>	Total Switching Loss		--	5.8	9.3	mJ
Q <sub>g</sub>	Total Gate Charge	V <sub>CE</sub> = 600 V, I <sub>C</sub> = 25A, V <sub>GE</sub> = 15V	--	200	300	nC
Q <sub>ge</sub>	Gate-Emitter Charge		--	15	23	nC
Q <sub>gc</sub>	Gate-Collector Charge		--	100	150	nC

### Notes:

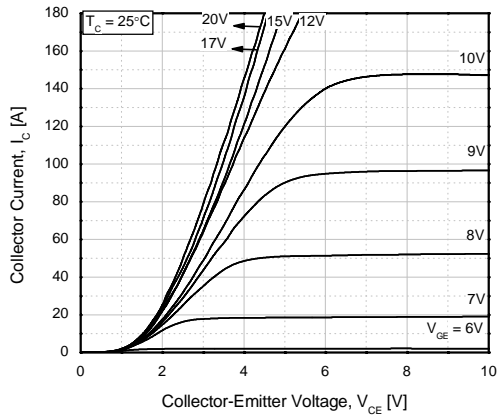
(1) Repetitive rating: Pulse width limited by max. junction temperature

**Electrical Characteristics of DIODE**  $T_C = 25^\circ\text{C}$  unless otherwise noted

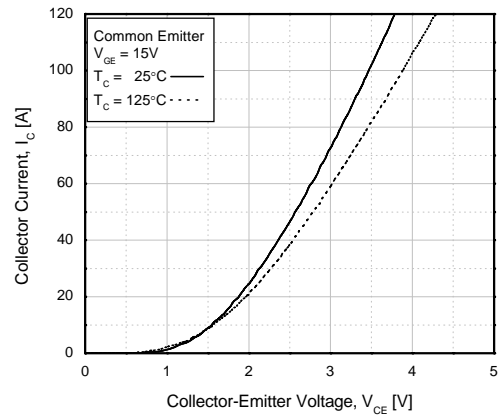
Symbol	Parameter	Test Conditions	Min.	Typ.	Max.	Units	
$V_{FM}$	Diode Forward Voltage	$I_F = 25\text{A}$	$T_C = 25^\circ\text{C}$	--	2.0	3.0	V
			$T_C = 125^\circ\text{C}$	--	2.1	--	
$t_{rr}$	Diode Reverse Recovery Time	$I_F = 25\text{A}$ $di/dt = 200\text{ A}/\mu\text{s}$	$T_C = 25^\circ\text{C}$	--	235	350	ns
			$T_C = 125^\circ\text{C}$	--	300	--	
$I_{rr}$	Diode Peak Reverse Recovery Current		$T_C = 25^\circ\text{C}$	--	27	40	A
			$T_C = 125^\circ\text{C}$	--	31	--	
$Q_{rr}$	Diode Reverse Recovery Charge		$T_C = 25^\circ\text{C}$	--	3130	4700	nC
			$T_C = 125^\circ\text{C}$	--	4650	--	

## Typical Performance Characteristics

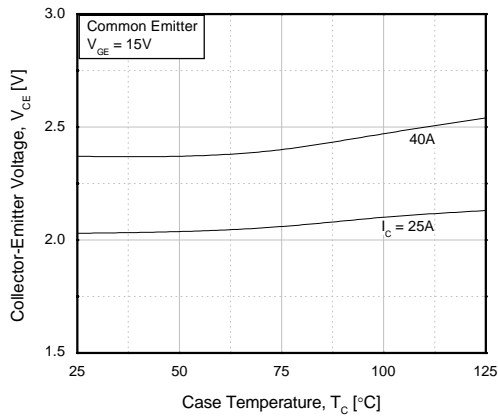
**Figure 1. Typical Output Characteristics**



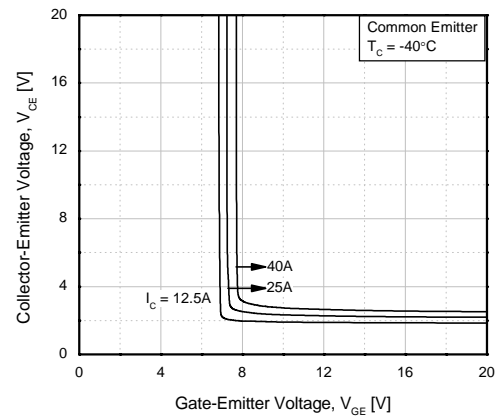
**Figure 2. Typical Saturation Voltage Characteristics**



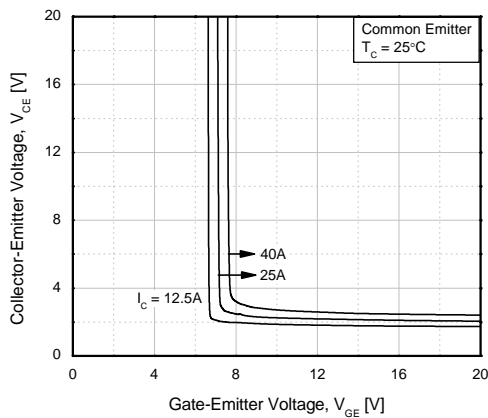
**Figure 3. Saturation Voltage vs. Case Temperature at Variant Current Level**



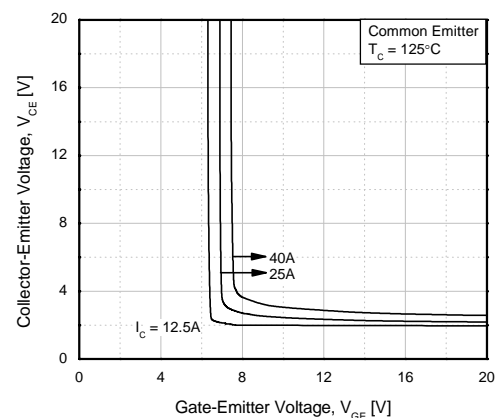
**Figure 4. Saturation Voltage vs. V\_GE**



**Figure 5. Saturation Voltage vs. V\_GE**

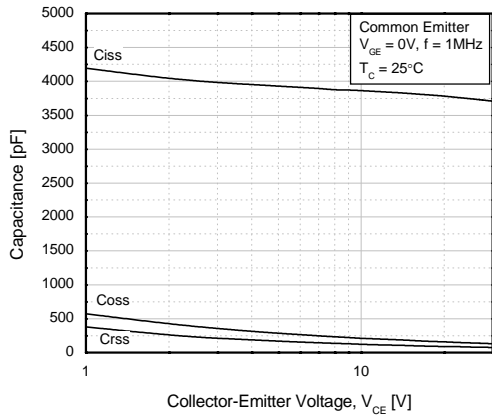


**Figure 6. Saturation Voltage vs. V\_GE**

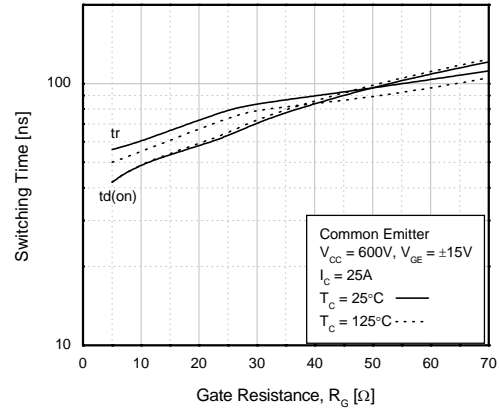


**Typical Performance Characteristics** (Continued)

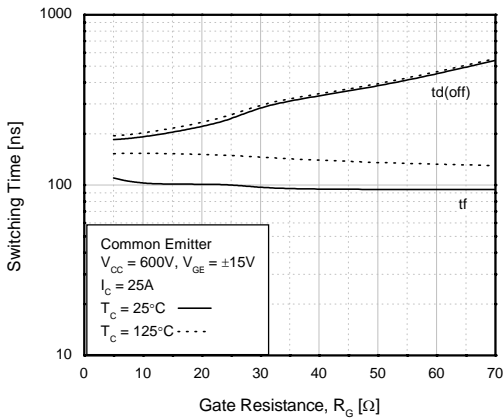
**Figure 7. Capacitance Characteristics**



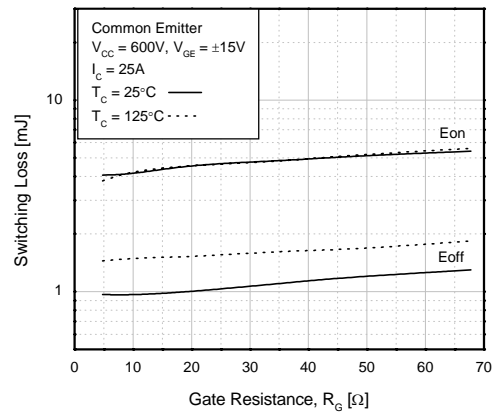
**Figure 8. Turn-On Characteristics vs. Gate Resistance**



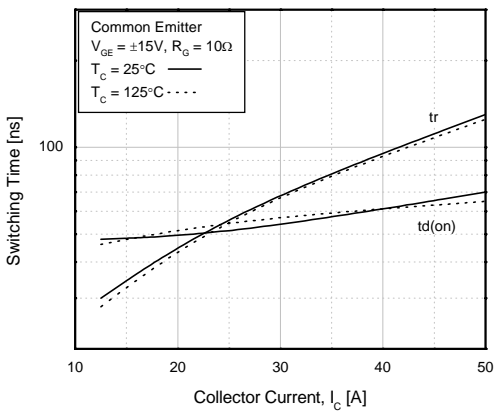
**Figure 9. Turn-Off Characteristics vs. Gate Resistance**



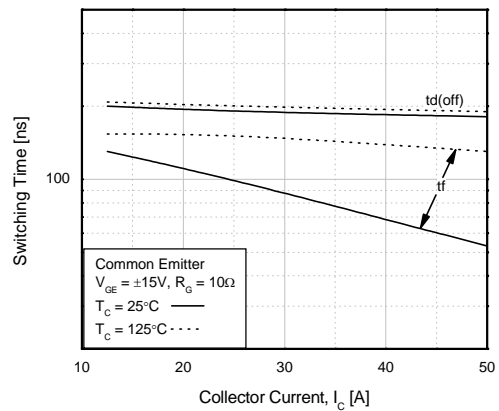
**Figure 10. Switching Loss vs. Gate Resistance**



**Figure 11. Turn-On Characteristics vs. Collector Current**

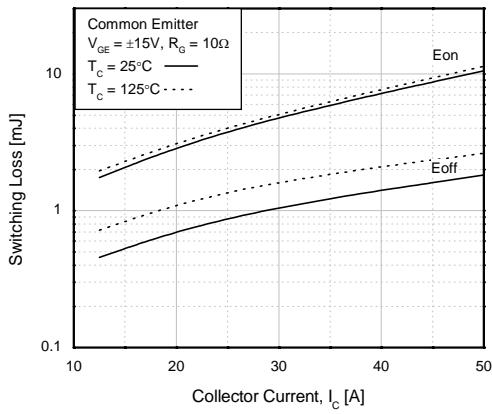


**Figure 12. Turn-Off Characteristics vs. Collector Current**

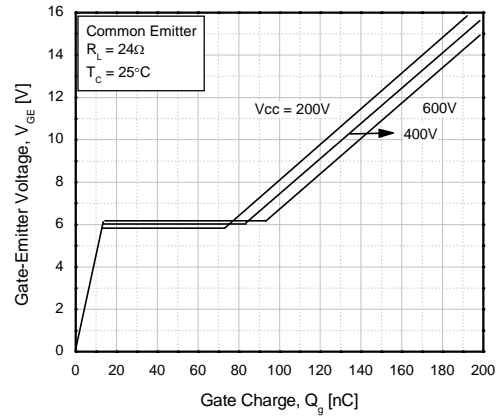


**Typical Performance Characteristics (Continued)**

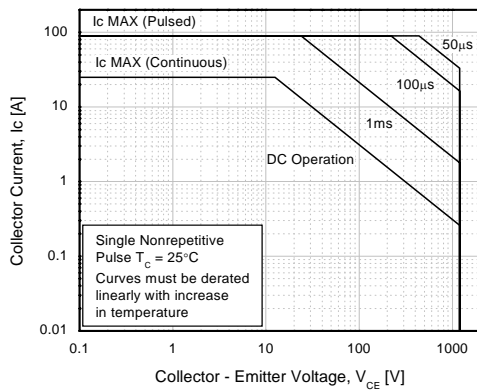
**Figure 13. Switching Loss vs. Collector Current**



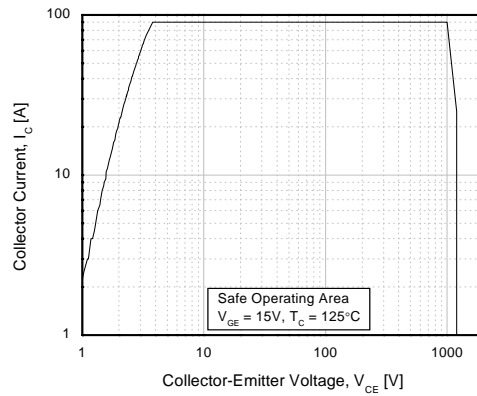
**Figure 14. Gate Charge Characteristics**



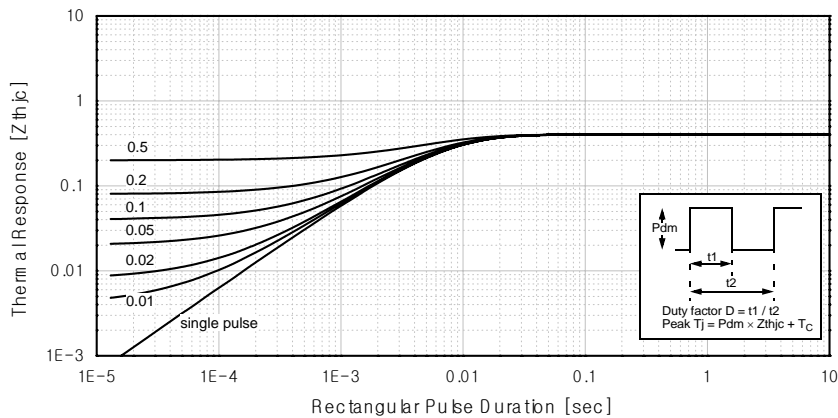
**Figure 15. SOA Characteristics**



**Figure 16. Turn-Off SOA**

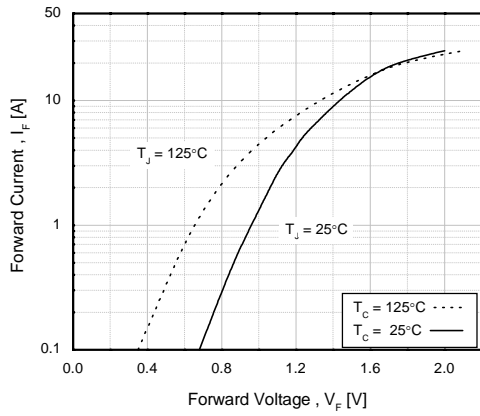


**Figure 17. Transient Thermal Impedance of IGBT**

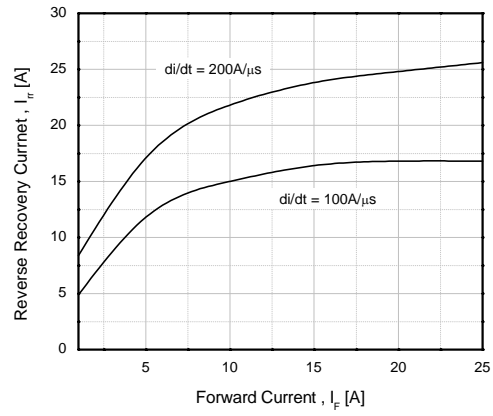


**Typical Performance Characteristics** (Continued)

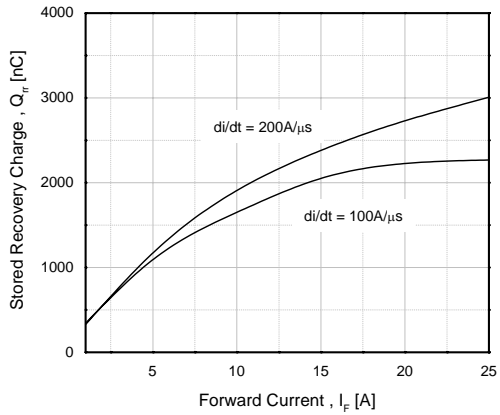
**Figure 18. Forward Characteristics**



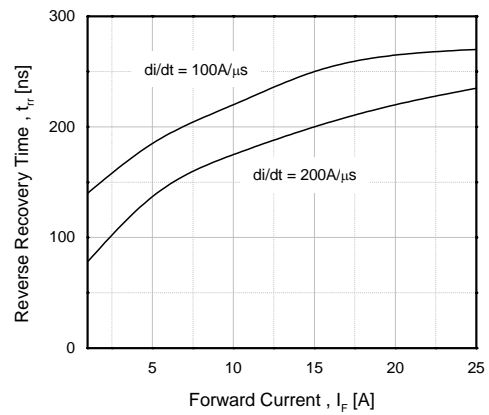
**Figure 19. Reverse Recovery Current**



**Figure 20. Stored Charge**

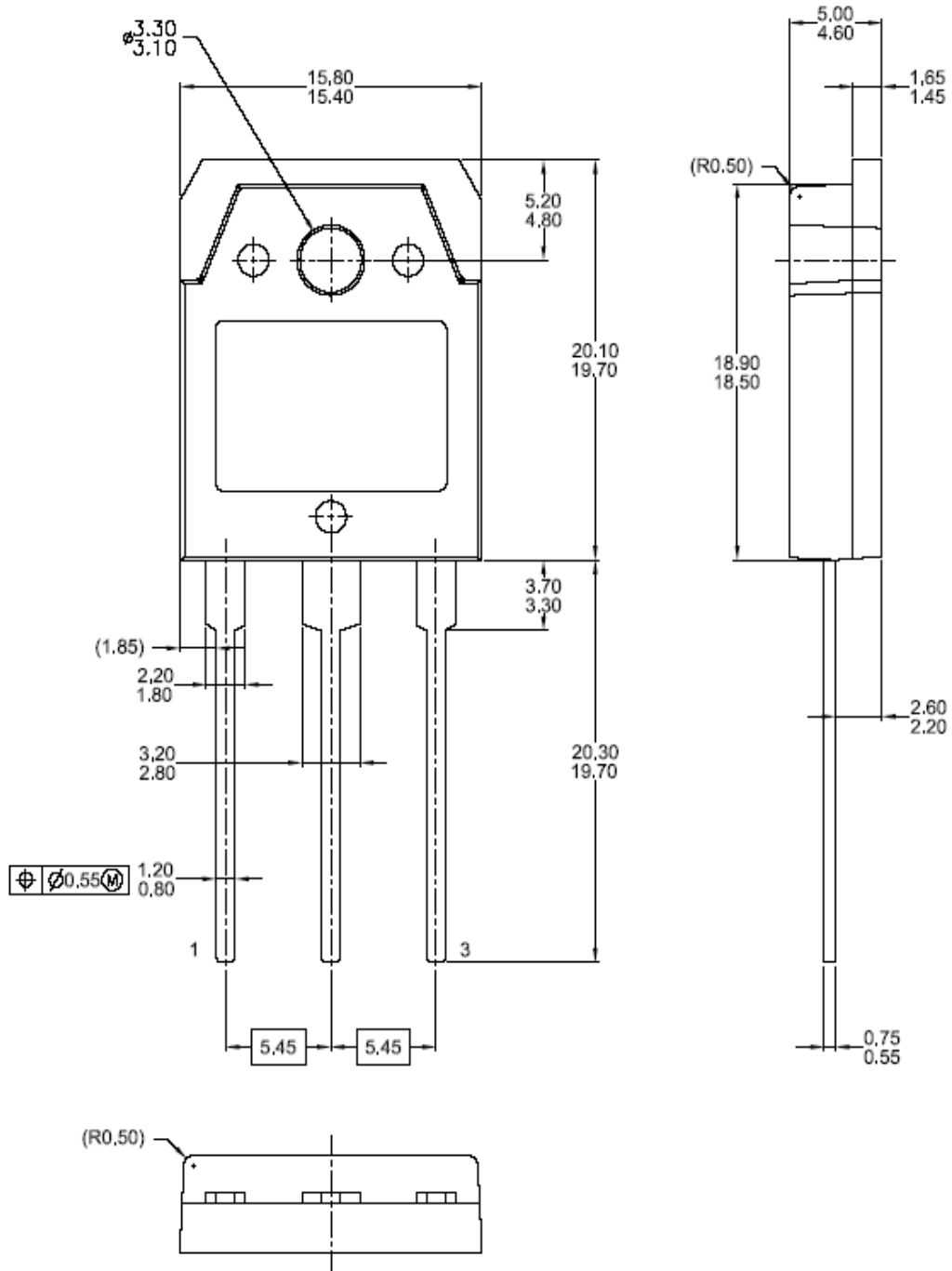


**Figure 21. Reverse Recovery Time**



Mechanical Dimensions (continued)

TO-3PN



Dimensions in Millimeters



## TRADEMARKS

The following are registered and unregistered trademarks Fairchild Semiconductor owns or is authorized to use and is not intended to be an exhaustive list of all such trademarks.

ACEx™	FACT Quiet Series™	OCX™	SILENT SWITCHER®	UniFET™
ActiveArray™	GlobalOptoisolator™	OCXPro™	SMART START™	UltraFET®
Bottomless™	GTO™	OPTOLOGIC®	SPM™	VCX™
Build it Now™	HiSeC™	OPTOPLANAR™	Stealth™	Wire™
CoolFET™	I <sup>2</sup> C™	PACMAN™	SuperFET™	
CROSSVOLT™	i-Lo™	POP™	SuperSOT™-3	
DOME™	ImpliedDisconnect™	Power247™	SuperSOT™-6	
EcoSPARK™	IntelliMAX™	PowerEdge™	SuperSOT™-8	
E <sup>2</sup> CMOS™	ISOPLANAR™	PowerSaver™	SyncFET™	
EnSigna™	LittleFET™	PowerTrench®	TCM™	
FACT™	MICROCOUPLER™	QFET®	TinyBoost™	
FAST®	MicroFET™	QS™	TinyBuck™	
FASTr™	MicroPak™	QT Optoelectronics™	TinyPWM™	
FPST™	MICROWIRE™	Quiet Series™	TinyPower™	
FRFET™	MSX™	RapidConfigure™	TinyLogic®	
	MSXPro™	RapidConnect™	TINYOPTO™	
Across the board. Around the world.™		µSerDes™	TruTranslation™	
The Power Franchise®		ScalarPump™	UHC™	
Programmable Active Droop™				

## DISCLAIMER

FAIRCHILD SEMICONDUCTOR RESERVES THE RIGHT TO MAKE CHANGES WITHOUT FURTHER NOTICE TO ANY PRODUCTS HEREIN TO IMPROVE RELIABILITY, FUNCTION OR DESIGN. FAIRCHILD DOES NOT ASSUME ANY LIABILITY ARISING OUT OF THE APPLICATION OR USE OF ANY PRODUCT OR CIRCUIT DESCRIBED HEREIN; NEITHER DOES IT CONVEY ANY LICENSE UNDER ITS PATENT RIGHTS, NOR THE RIGHTS OF OTHERS. THESE SPECIFICATIONS DO NOT EXPAND THE TERMS OF FAIRCHILD'S WORLDWIDE TERMS AND CONDITIONS, SPECIFICALLY THE WARRANTY THEREIN, WHICH COVERS THESE PRODUCTS.

## LIFE SUPPORT POLICY

FAIRCHILD'S PRODUCTS ARE NOT AUTHORIZED FOR USE AS CRITICAL COMPONENTS IN LIFE SUPPORT DEVICES OR SYSTEMS WITHOUT THE EXPRESS WRITTEN APPROVAL OF FAIRCHILD SEMICONDUCTOR CORPORATION.

As used herein:

1. Life support devices or systems are devices or systems which, (a) are intended for surgical implant into the body, or (b) support or sustain life, or (c) whose failure to perform when properly used in accordance with instructions for use provided in the labeling, can be reasonably expected to result in significant injury to the user.
2. A critical component is any component of a life support device or system whose failure to perform can be reasonably expected to cause the failure of the life support device or system, or to affect its safety or effectiveness.

## PRODUCT STATUS DEFINITIONS

### Definition of Terms

Datasheet Identification	Product Status	Definition
Advance Information	Formative or In Design	This datasheet contains the design specifications for product development. Specifications may change in any manner without notice.
Preliminary	First Production	This datasheet contains preliminary data, and supplementary data will be published at a later date. Fairchild Semiconductor reserves the right to make changes at any time without notice in order to improve design.
No Identification Needed	Full Production	This datasheet contains final specifications. Fairchild Semiconductor reserves the right to make changes at any time without notice in order to improve design.
Obsolete	Not In Production	This datasheet contains specifications on a product that has been discontinued by Fairchild semiconductor. The datasheet is printed for reference information only.

Rev. I20