

# MBRS1540T3

## Surface Mount Schottky Power Rectifier

### SMB Power Surface Mount Package

These devices employ the Schottky Barrier principle in a metal-to-silicon power rectifier. Features epitaxial construction with oxide passivation and metal overlay contact. Ideally suited for low voltage, high frequency switching power supplies; free wheeling diodes and polarity protection diodes.

#### Features

- Compact Package with J-Bend Leads Ideal for Automated Handling
- Highly Stable Oxide Passivated Junction
- Guard-Ring for Over-Voltage Protection
- Low Forward Voltage Drop
- Pb-Free Package is Available

#### Mechanical Characteristics

- Case: Molded Epoxy
- Epoxy Meets UL 94 V-0 @ 0.125 in
- Weight: 95 mg (Approximately)
- Cathode Polarity Band
- Lead and Mounting Surface Temperature for Soldering Purposes: 260°C Max. for 10 Seconds
- Finish: All External Surfaces Corrosion Resistant and Terminal Leads are Readily Solderable

#### MAXIMUM RATINGS

Rating	Symbol	Value	Unit
Peak Repetitive Reverse Voltage Working Peak Reverse Voltage DC Blocking Voltage	$V_{RRM}$ $V_{RWM}$ $V_R$	40	V
Average Rectified Forward Current (At Rated $V_R$ , $T_C = 100^\circ\text{C}$ )	$I_O$	1.5	A
Peak Repetitive Forward Current (At Rated $V_R$ , Square Wave, 100 kHz, $T_C = 105^\circ\text{C}$ )	$I_{FRM}$	3.0	A
Non-Repetitive Peak Surge Current (Surge Applied at Rated Load Conditions Halfwave, Single Phase, 60 Hz)	$I_{FSM}$	40	A
Storage/Operating Case Temperature	$T_{stg}, T_C$	-55 to +150	°C
Operating Junction Temperature	$T_J$	-55 to +125	°C
Voltage Rate of Change (Rated $V_R$ , $T_J = 25^\circ\text{C}$ )	$dv/dt$	10,000	V/ $\mu\text{s}$

Maximum ratings are those values beyond which device damage can occur. Maximum ratings applied to the device are individual stress limit values (not normal operating conditions) and are not valid simultaneously. If these limits are exceeded, device functional operation is not implied, damage may occur and reliability may be affected.



ON Semiconductor®

<http://onsemi.com>

### SCHOTTKY BARRIER RECTIFIER 1.5 AMPERES, 40 VOLTS



SMB  
CASE 403A  
PLASTIC

#### MARKING DIAGRAM



BGJ = Specific Device Code

A = Assembly Location

Y = Year

WW = Work Week

▪ = Pb-Free Package

(Note: Microdot may be in either location)

#### ORDERING INFORMATION

Device	Package	Shipping†
MBRS1540T3	SMB	2500/Tape & Reel
MBRS1540T3G	SMB (Pb-Free)	2500/Tape & Reel

†For information on tape and reel specifications, including part orientation and tape sizes, please refer to our Tape and Reel Packaging Specification Brochure, BRD8011/D.

# MBRS1540T3

## THERMAL CHARACTERISTICS

Characteristic	Symbol	Value	Unit
Thermal Resistance, Junction-to-Lead (Note 1)	$R_{\theta JL}$	24	$^{\circ}C/W$
Thermal Resistance, Junction-to-Ambient (Note 2)	$R_{\theta JA}$	80	

## ELECTRICAL CHARACTERISTICS

Characteristic	Symbol	$T_J = 25^{\circ}C$	$T_J = 125^{\circ}C$	Unit
Maximum Instantaneous Forward Voltage (Note 3)  see Figure 2	$V_F$	0.46 0.54	0.39 0.54	V
Maximum Instantaneous Reverse Current (Note 3)  see Figure 4	$I_R$	0.8 0.1	5.7 1.6	mA

1. Mounted with minimum recommended pad size, PC Board FR4.
2. 1 inch square pad size (1 x 0.5 inch for each lead) on FR4 board.
3. Pulse Test: Pulse Width  $\leq 250 \mu s$ , Duty Cycle  $\leq 2.0\%$ .

# MBRS1540T3

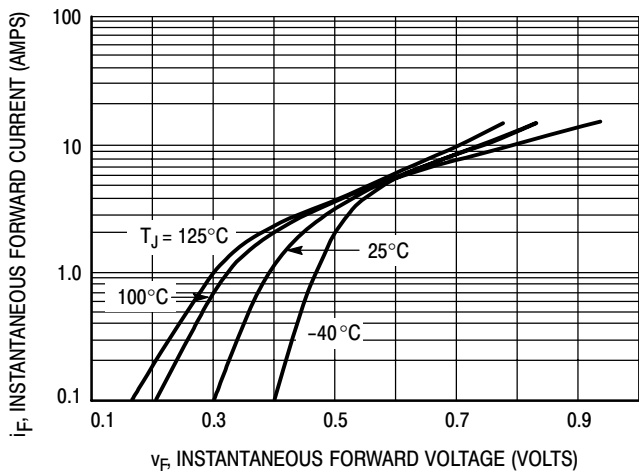

Figure 1. Typical Forward Voltage

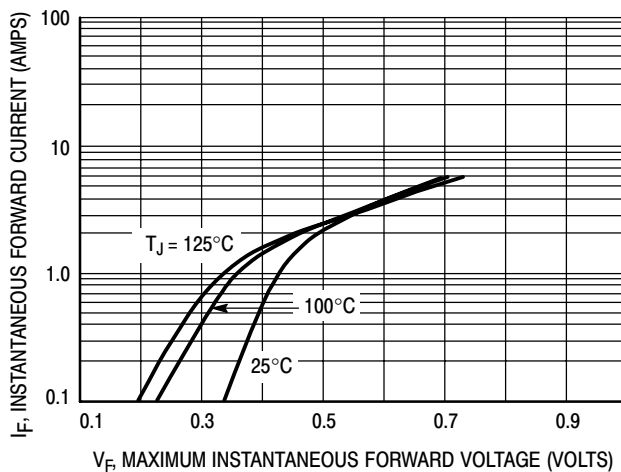

Figure 2. Maximum Forward Voltage

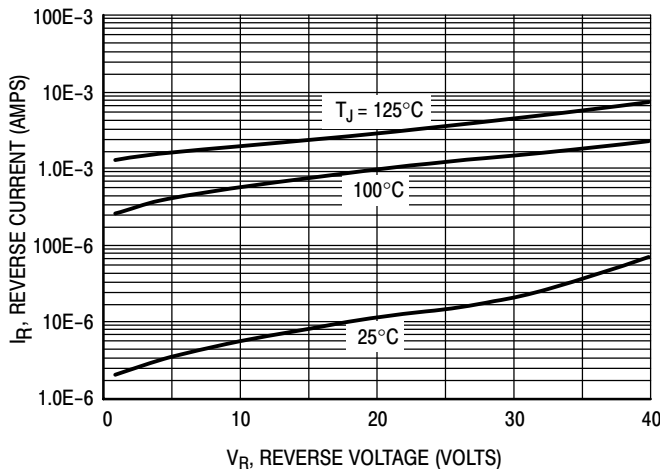

Figure 3. Typical Reverse Current

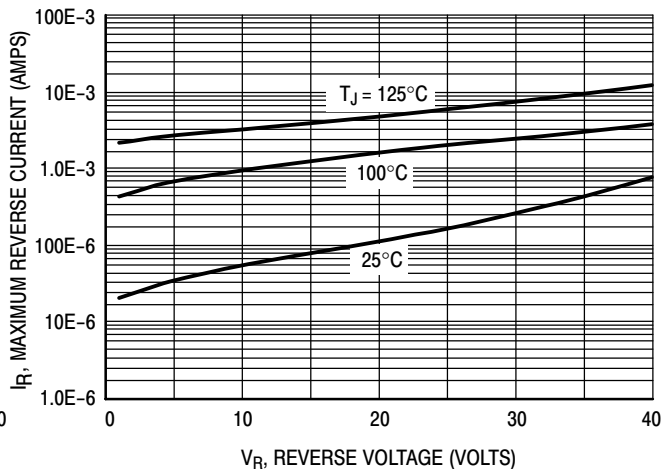

Figure 4. Maximum Reverse Current

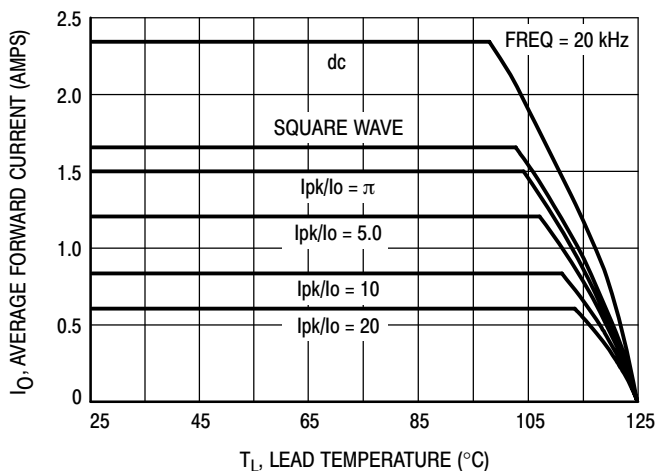

Figure 5. Current Derating

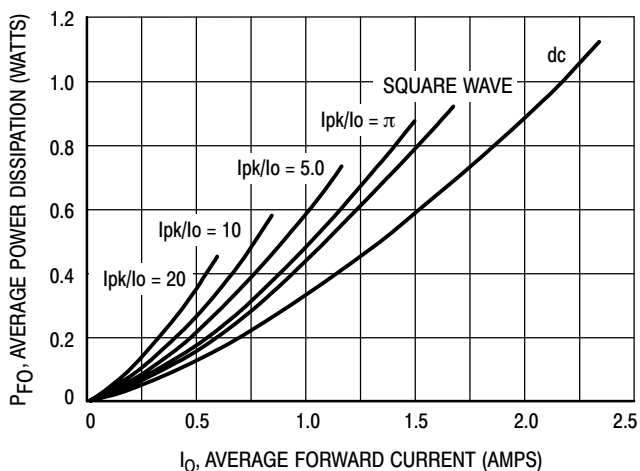

Figure 6. Forward Power Dissipation

# MBRS1540T3

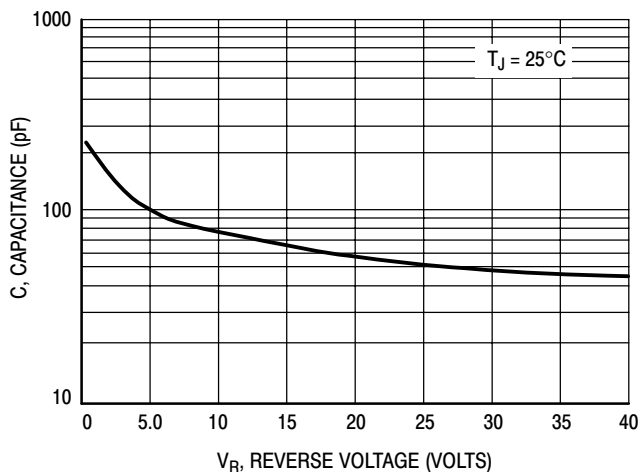

Figure 7. Capacitance

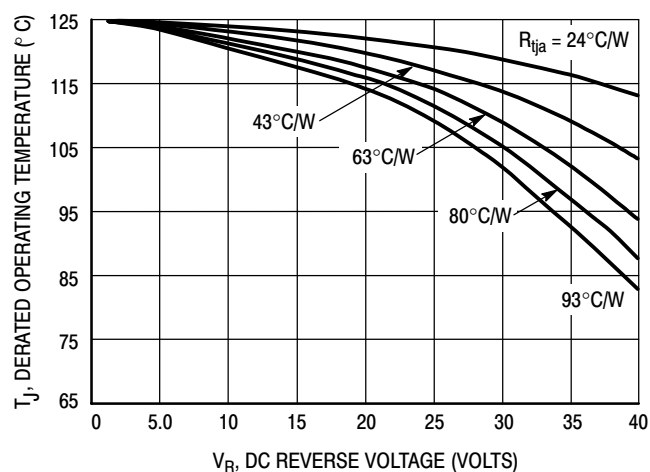

Figure 8. Typical Operating Temperature Derating\*

\* Reverse power dissipation and the possibility of thermal runaway must be considered when operating this device under any reverse voltage conditions. Calculations of  $T_J$  therefore must include forward and reverse power effects. The allowable operating  $T_J$  may be calculated from the equation:

$$T_J = T_{Jmax} - r(t)(P_f + P_r) \text{ where}$$

$r(t)$  = thermal impedance under given conditions,  
 $P_f$  = forward power dissipation, and  
 $P_r$  = reverse power dissipation

This graph displays the derated allowable  $T_J$  due to reverse bias under DC conditions only and is calculated as  $T_J = T_{Jmax} - r(t)P_r$ , where  $r(t) = R_{thja}$ . For other power applications further calculations must be performed.

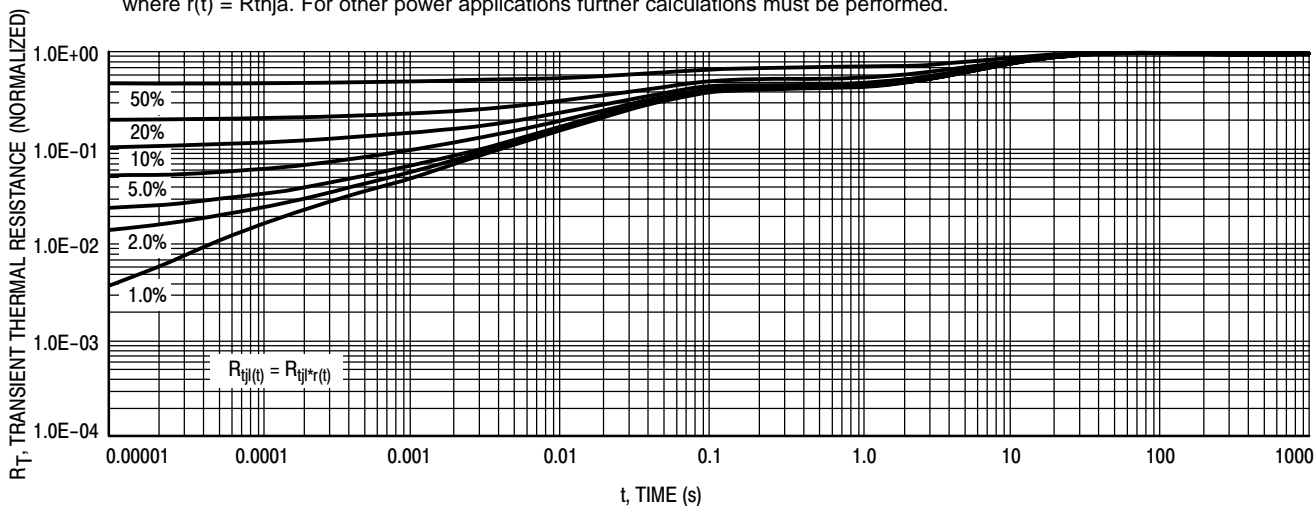

Figure 9. Thermal Response — Junction to Case

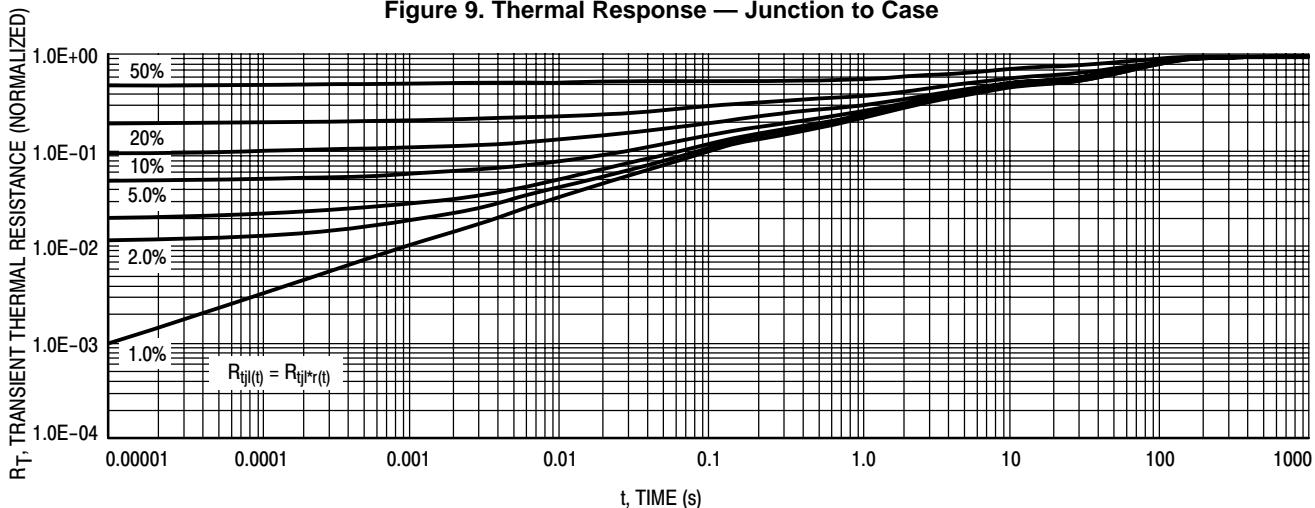
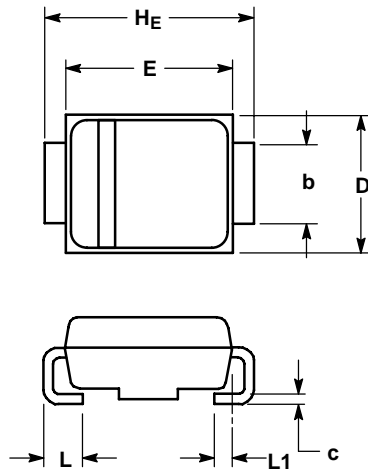

Figure 10. Thermal Response — Junction to Ambient

# MBRS1540T3

## PACKAGE DIMENSIONS

SMB  
PLASTIC PACKAGE  
CASE 403A-03  
ISSUE E



NOTES:

1. DIMENSIONING AND TOLERANCING PER ANSI Y14.5M, 1982.
2. CONTROLLING DIMENSION: INCH.
3. D DIMENSION SHALL BE MEASURED WITHIN DIMENSION P.

DIM	MILLIMETERS			INCHES		
	MIN	NOM	MAX	MIN	NOM	MAX
A	1.90	2.13	2.41	0.075	0.084	0.095
A1	0.05	0.10	0.15	0.002	0.004	0.006
b	1.96	2.03	2.11	0.077	0.080	0.083
c	0.15	0.23	0.30	0.006	0.009	0.012
D	3.30	3.56	3.81	0.130	0.140	0.150
E	4.06	4.32	4.57	0.160	0.170	0.180
HE	5.21	5.44	5.59	0.205	0.214	0.220
L	0.76	1.02	1.27	0.030	0.040	0.050
L1	0.51 REF			0.020 REF		

### SOLDERING FOOTPRINT\*

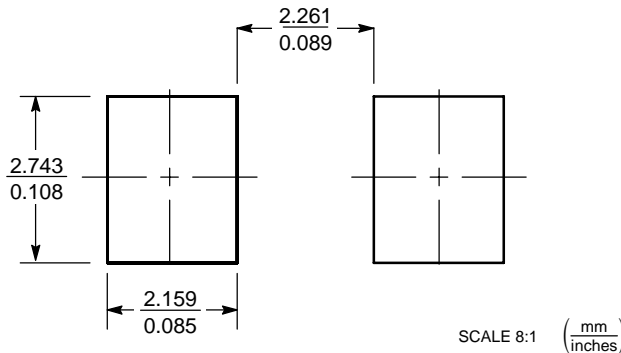

\*For additional information on our Pb-Free strategy and soldering details, please download the ON Semiconductor Soldering and Mounting Techniques Reference Manual, SOLDERRM/D.

ON Semiconductor and are registered trademarks of Semiconductor Components Industries, LLC (SCILLC). SCILLC reserves the right to make changes without further notice to any products herein. SCILLC makes no warranty, representation or guarantee regarding the suitability of its products for any particular purpose, nor does SCILLC assume any liability arising out of the application or use of any product or circuit, and specifically disclaims any and all liability, including without limitation special, consequential or incidental damages. "Typical" parameters which may be provided in SCILLC data sheets and/or specifications can and do vary in different applications and actual performance may vary over time. All operating parameters, including "Typicals" must be validated for each customer application by customer's technical experts. SCILLC does not convey any license under its patent rights nor the rights of others. SCILLC products are not designed, intended, or authorized for use as components in systems intended for surgical implant into the body, or other applications intended to support or sustain life, or for any other application in which the failure of the SCILLC product could create a situation where personal injury or death may occur. Should Buyer purchase or use SCILLC products for any such unintended or unauthorized application, Buyer shall indemnify and hold SCILLC and its officers, employees, subsidiaries, affiliates, and distributors harmless against all claims, costs, damages, and expenses, and reasonable attorney fees arising out of, directly or indirectly, any claim of personal injury or death associated with such unintended or unauthorized use, even if such claim alleges that SCILLC was negligent regarding the design or manufacture of the part. SCILLC is an Equal Opportunity/Affirmative Action Employer. This literature is subject to all applicable copyright laws and is not for resale in any manner.

### PUBLICATION ORDERING INFORMATION

**LITERATURE FULFILLMENT:**  
Literature Distribution Center for ON Semiconductor  
P.O. Box 61312, Phoenix, Arizona 85082-1312 USA  
**Phone:** 480-829-7710 or 800-344-3860 Toll Free USA/Canada  
**Fax:** 480-829-7709 or 800-344-3867 Toll Free USA/Canada  
**Email:** orderlit@onsemi.com

**N. American Technical Support:** 800-282-9855 Toll Free  
USA/Canada

**Japan:** ON Semiconductor, Japan Customer Focus Center  
2-9-1 Kamimeguro, Meguro-ku, Tokyo, Japan 153-0051  
**Phone:** 81-3-5773-3850

**ON Semiconductor Website:** <http://onsemi.com>

**Order Literature:** <http://www.onsemi.com/litorder>

For additional information, please contact your local Sales Representative.

**MBRS1540T3/D**