

HiPerDynFRED

High Performance Dynamic Fast Recovery Diode
Extreme Low Loss and Soft Recovery
Single Diode

Part number

DSEP30-12CR

$$\begin{aligned} V_{RRM} &= 1200 \text{ V} \\ I_{FAV} &= 30 \text{ A} \\ t_{rr} &= 15 \text{ ns} \end{aligned}$$

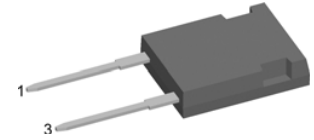
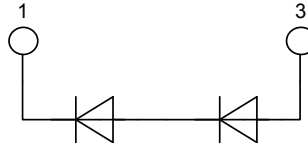

Backside: isolated

E72873

Features / Advantages:

- Planar passivated chips
- Very low leakage current
- Very short recovery time
- Improved thermal behaviour
- Very low I_{rm}-values
- Very soft recovery behaviour
- Soft reverse recovery for low EMI/RFI
- Low I_{rm} reduces:
 - Power dissipation within the diode
 - Turn-on loss in the commutating switch

Applications:

- Antiparallel diode for high frequency switching devices
- Antisaturation diode
- Snubber diode
- Free wheeling diode
- Rectifiers in switch mode power supplies (SMPS)
- Uninterruptible power supplies (UPS)

Package:

- Housing: ISOPLUS247
- Industry standard outline
- DCB isolated backside
- Isolation Voltage 3000 V
- Epoxy meets UL 94V-0
- RoHS compliant

Symbol	Definition	Conditions	Ratings			Unit
			min.	typ.	max.	
V_{RRM}	max. repetitive reverse voltage				1200	V
I_R	reverse current	$V_R = 1200 \text{ V}$			250	μA
		$V_R = 1200 \text{ V}$			2	mA
V_F	forward voltage	$I_F = 30 \text{ A}$			4.98	V
		$I_F = 60 \text{ A}$			6.33	V
		$I_F = 30 \text{ A}$			3.18	V
		$I_F = 60 \text{ A}$			4.40	V
I_{FAV}	average forward current	rectangular d = 0.5			30	A
V_{FO}	threshold voltage	} for power loss calculation only			1.42	V
r_F	slope resistance				24.4	m Ω
R_{thJC}	thermal resistance junction to case				0.60	K/W
T_{VJ}	virtual junction temperature		-55		175	$^{\circ}\text{C}$
P_{tot}	total power dissipation				250	W
I_{FSM}	max. forward surge current	t = 10 ms (50 Hz), sine			250	A
I_{RM}	max. reverse recovery current				5.5	A
		$I_F = 30 \text{ A}; V_R = 600 \text{ V}$			12.5	A
t_{rr}	reverse recovery time	-di _F /dt = 600 A/ μs			15	ns
					70	ns
C_J	junction capacitance	$V_R = 800 \text{ V}; f = 1 \text{ MHz}$			13	pF

Symbol	Definition	Conditions	Ratings			Unit
			min.	typ.	max.	
I_{RMS}	RMS current	per terminal			70	A
R_{thCH}	thermal resistance case to heatsink			0.25		K/W
T_{stg}	storage temperature		-55		150	°C
Weight				6		g
F_C	mounting force with clip		20		120	N
V_{ISOL}	isolation voltage	t = 1 second	3600			V
		t = 1 minute	3000			V
$d_{Spp/App}$	creepage striking distance on surface through air	terminal to terminal	5.5			mm
$d_{Spb/Apb}$	creepage striking distance on surface through air	terminal to backside	5.5			mm

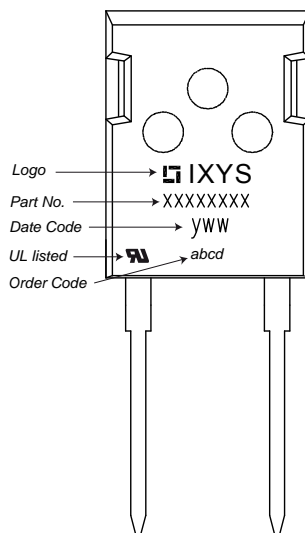
Product Marking

Ordering	Part Name	Marking on Product	Delivering Mode	Base Qty	Code Key
Standard	DSEP30-12CR	DSEP30-12CR	Tube	30	481955

Similar Part	Package	Voltage Class
DSEP30-12A	TO-247AD (2)	1200
DSEP29-12A	TO-220AC (2)	1200
DSEP30-12AR	ISOPLUS247 (2)	1200
DHG30I1200HA	TO-247AD (2)	1200

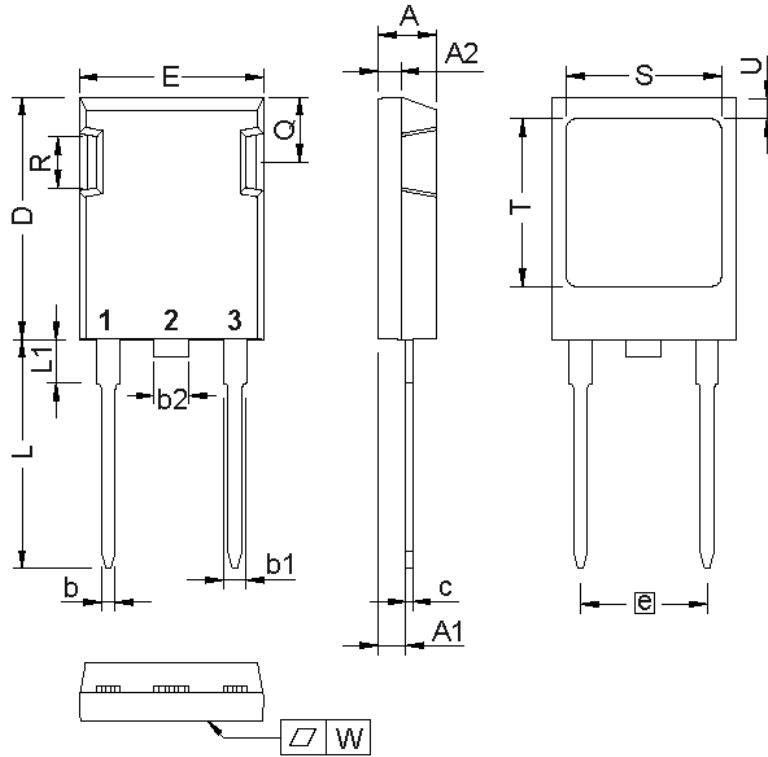
Outlines ISOPLUS247

Dim.	Millimeter		Inches	
	min	max	min	max
A	4.83	5.21	0.190	0.205
A1	2.29	2.54	0.090	0.100
A2	1.91	2.16	0.075	0.085
b	1.14	1.40	0.045	0.055
b1	1.91	2.15	0.075	0.085
b2	2.92	3.20	0.115	0.126
c	0.61	0.83	0.024	0.033
D	20.80	21.34	0.819	0.840
E	15.75	16.13	0.620	0.635
e	10.90 BSC		0.430 BSC	
L	19.81	20.60	0.780	0.811
L1	3.81	4.38	0.150	0.172
L2	0.00	2.54	0.000	0.100
Q	5.59	6.20	0.220	0.244
R	4.32	4.85	0.170	0.191
S	13.21	13.72	0.520	0.540
T	15.75	16.26	0.620	0.640
U	1.65	2.03	0.065	0.080
W	-	0.10	-	0.004

Die konvexe Form des Substrates ist typ. < 0.04 mm über der Kunststoffoberfläche der Bauteilunterseite
 The convex bow of substrate is typ. < 0.04 mm over plastic surface level of device bottom side

Die Gehäuseabmessungen entsprechen dem Typ TO-247 AD gemäß JEDEC außer Schraubloch und L_{max} .
 This drawing will meet all dimensions requirement of JEDEC outline TO-247 AD except screw hole and except L_{max} .

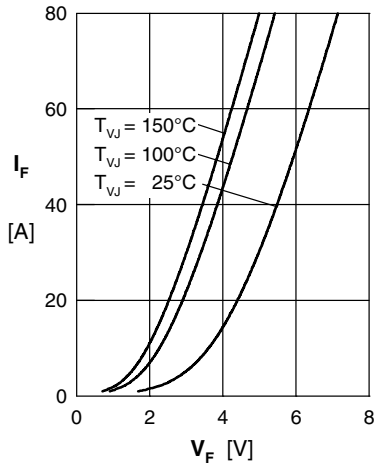

Fig. 1 Forward current I_F vs. V_F

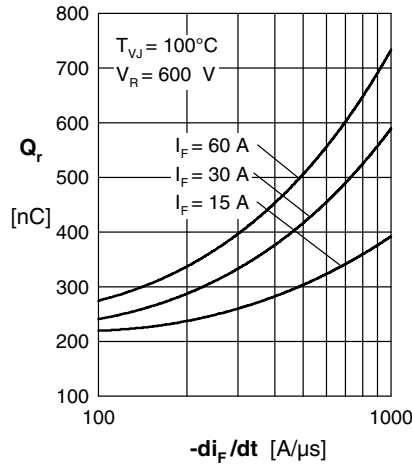

Fig. 2 Reverse recovery charge Q_r versus $-di_F/dt$

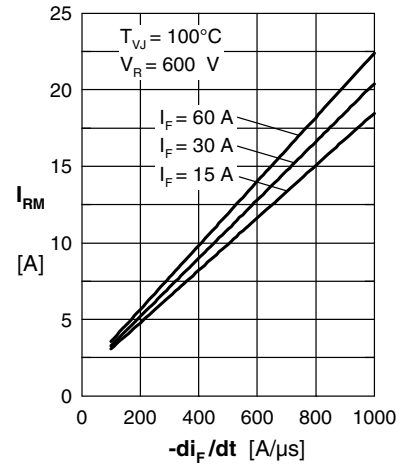

Fig. 3 Peak reverse current I_{RM} versus $-di_F/dt$

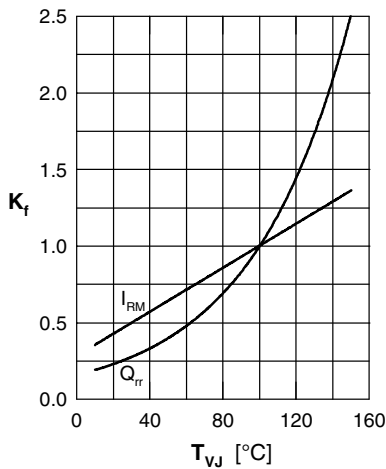

Fig. 4 Dynamic parameters Q_r , I_{RM} versus T_{VJ}

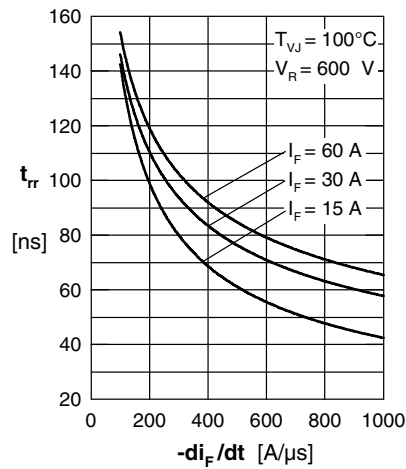

Fig. 5 Recovery time t_{tr} versus $-di_F/dt$

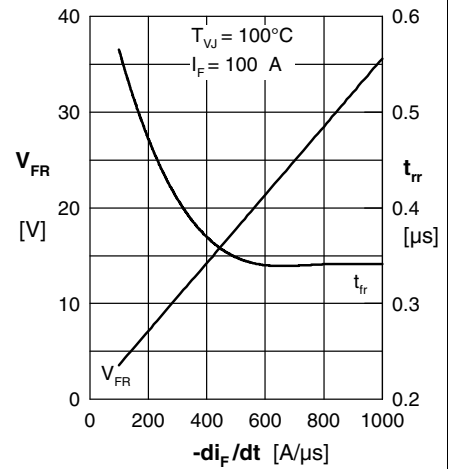

Fig. 6 Peak forward voltage V_{FR} and t_{tr} versus di_F/dt

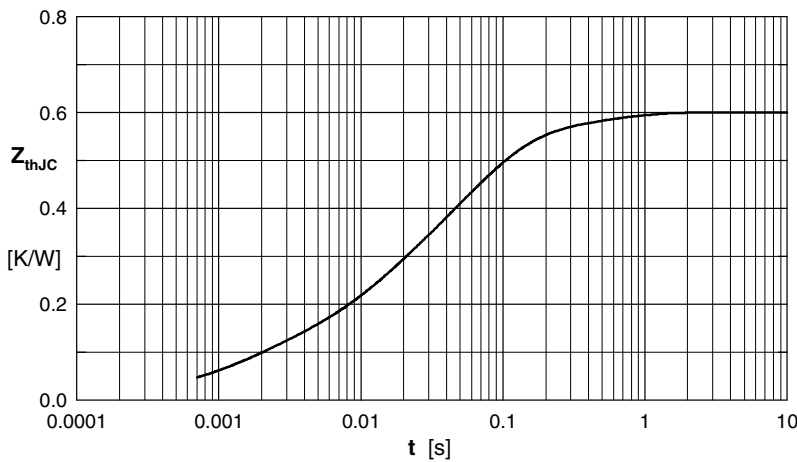

Fig. 7 Transient thermal resistance junction to case

Constants for Z_{thJC} calculation:

i	R_{thi} (K/W)	t_i (s)
1	0.08	0.0013
2	0.122	0.0097
3	0.116	0.037
4	0.23	0.07
5	0.052	0.45