

HiPerFRED

High Performance Fast Recovery Diode
Low Loss and Soft Recovery
Single Diode

Part number

DSEP40-03AS

$$\begin{aligned} V_{RRM} &= 300 \text{ V} \\ I_{FAV} &= 40 \text{ A} \\ t_{rr} &= 35 \text{ ns} \end{aligned}$$

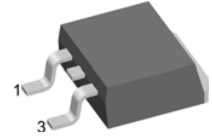
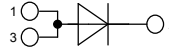

Backside: cathode

Features / Advantages:

- Planar passivated chips
- Very low leakage current
- Very short recovery time
- Improved thermal behaviour
- Very low I_{rm}-values
- Very soft recovery behaviour
- Avalanche voltage rated for reliable operation
- Soft reverse recovery for low EMI/RFI
- Low I_{rm} reduces:
 - Power dissipation within the diode
 - Turn-on loss in the commutating switch

Applications:

- Antiparallel diode for high frequency switching devices
- Antisaturation diode
- Snubber diode
- Free wheeling diode
- Rectifiers in switch mode power supplies (SMPS)
- Uninterruptible power supplies (UPS)

Package:

- Housing: TO-263 (D2Pak)
- Industry standard outline
- Epoxy meets UL 94V-0
- RoHS compliant

Symbol	Definition	Conditions	Ratings			Unit
			min.	typ.	max.	
V_{RRM}	max. repetitive reverse voltage				300	V
I_R	reverse current	$V_R = 300 \text{ V}$			1	μA
		$V_R = 300 \text{ V}$			0.1	mA
V_F	forward voltage	$I_F = 40 \text{ A}$			1.44	V
		$I_F = 80 \text{ A}$			1.81	V
		$I_F = 40 \text{ A}$			1.18	V
		$I_F = 80 \text{ A}$			1.58	V
I_{FAV}	average forward current	rectangular d = 0.5			40	A
V_{FO}	threshold voltage	} for power loss calculation only			0.72	V
r_F	slope resistance				10	m Ω
R_{thJC}	thermal resistance junction to case				0.85	K/W
T_{VJ}	virtual junction temperature		-55		175	$^{\circ}\text{C}$
P_{tot}	total power dissipation				185	W
I_{FSM}	max. forward surge current	t = 10 ms (50 Hz), sine			340	A
I_{RM}	max. reverse recovery current				3	A
		$I_F = 30 \text{ A}; V_R = 200 \text{ V}$			7	A
t_{rr}	reverse recovery time	-di _F /dt = 200 A/ μs			35	ns
					55	ns
C_J	junction capacitance	$V_R = 150 \text{ V}; f = 1 \text{ MHz}$			50	pF

Symbol	Definition	Conditions	Ratings			Unit
			min.	typ.	max.	
I_{RMS}	<i>RMS current</i>	per pin ¹⁾			35	A
R_{thCH}	<i>thermal resistance case to heatsink</i>			0.25		K/W
T_{stg}	<i>storage temperature</i>		-55		150	°C
Weight				2		g
F_c	<i>mounting force with clip</i>		20		60	N

¹⁾ I_{RMS} is typically limited by: 1. pin-to-chip resistance; or by 2. current capability of the chip.
 In case of 1, a common cathode/anode configuration and a non-isolated backside, the whole current capability can be used by connecting the backside.

Product Marking

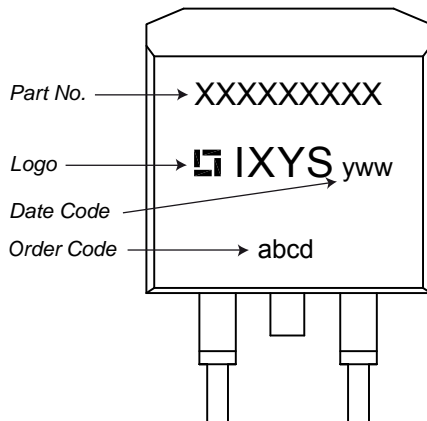

Ordering	Part Name	Marking on Product	Delivering Mode	Base Qty	Code Key
Standard	DSEP40-03AS	DSEP40-03AS	Tape & Reel	800	501174

Outlines TO-263 (D2Pak)

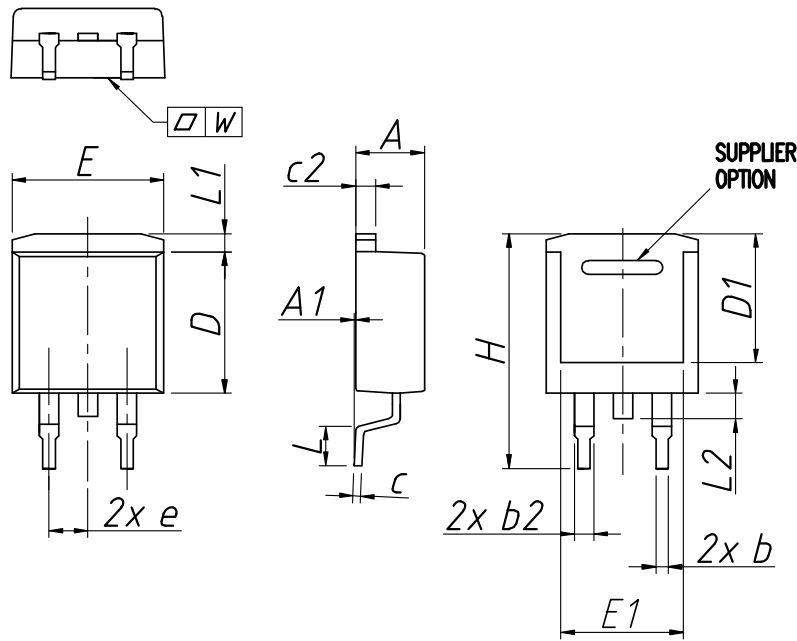

Dim.	Millimeter		Inches	
	min	max	min	max
A	4.06	4.83	0.160	0.190
A1	typ. 0.10		typ. 0.004	
b	0.51	0.99	0.020	0.039
b2	1.14	1.40	0.045	0.055
c	0.40	0.74	0.016	0.029
c2	1.14	1.40	0.045	0.029
D	8.38	9.40	0.330	0.370
D1	8.00	8.89	0.315	0.350
E	9.65	10.41	0.380	0.410
E1	6.22	8.20	0.245	0.323
e	2,54 BSC		0,100 BSC	
H	14.61	15.88	0.575	0.625
L	1.78	2.79	0.070	0.110
L1	1.02	1.68	0.040	0.066
L2	1.02	1.52	0.040	0.060
W	typ. 0.02		typ. 0.0008	
	0.02	0.040	0.0008	0.0016

All dimensions conform with and/or are within JEDEC standard.

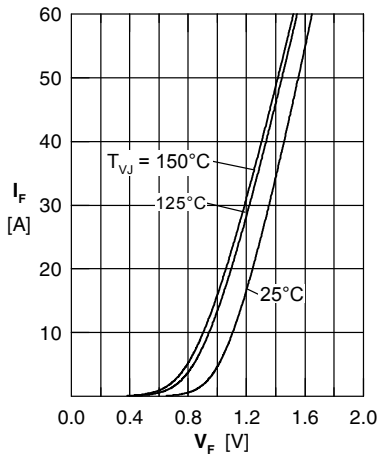

Fig. 1 Forward current I_F versus forward voltage V_F

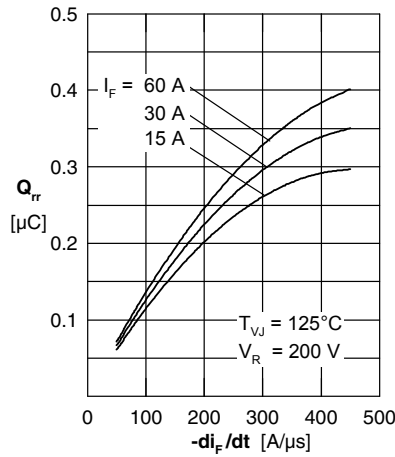

Fig. 2 Typ. reverse recovery charge Q_{rr} versus $-di_F/dt$

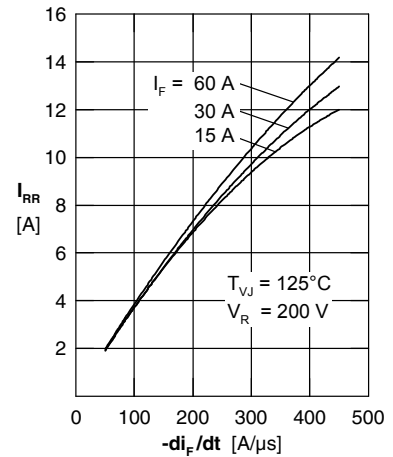

Fig. 3 Typ. reverse recovery current I_{RR} versus $-di_F/dt$

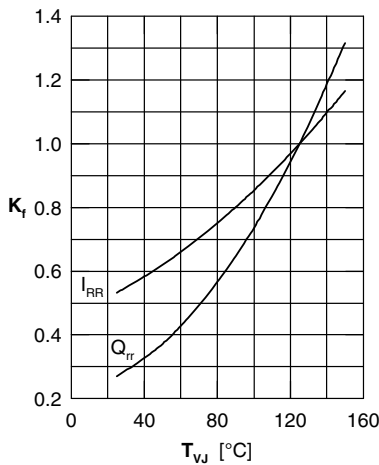

Fig. 4 Dynamic parameters Q_{rr} , I_{RR} versus T_{VJ}

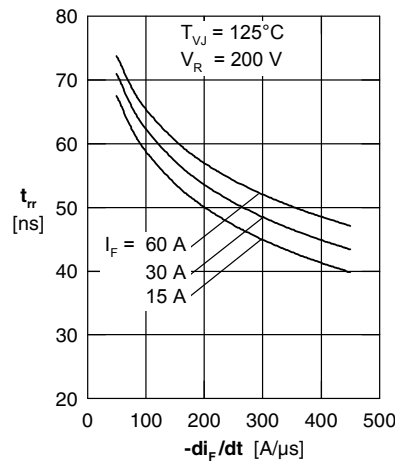

Fig. 5 Typ. reverse recovery time t_{rr} versus $-di_F/dt$

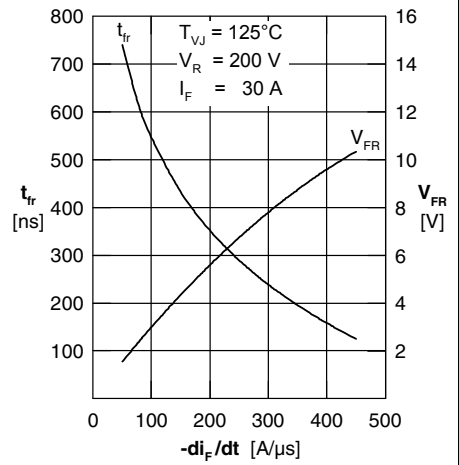

Fig. 6 Typ. forward recovery voltage V_{FR} & forward recovery time t_{fr} vs. di_F/dt

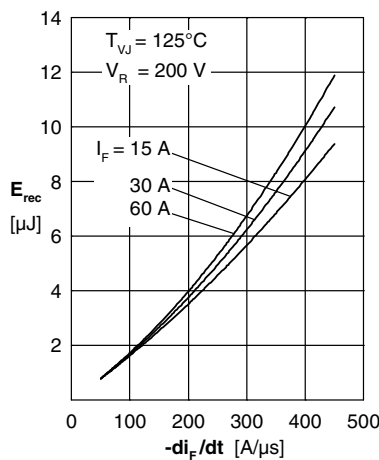

Fig. 7 Typ. recovery energy E_{rec} versus $-di_F/dt$

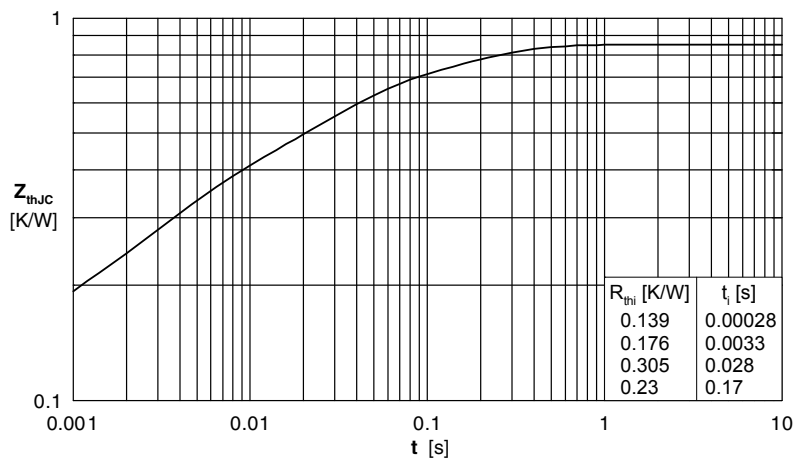

Fig. 8 Transient thermal impedance junction to case