

# Fast Recovery Epitaxial Diode (FRED)

$$I_{FAV} = 8 \text{ A}$$

$$V_{RRM} = 600 \text{ V}$$

$$t_{rr} = 35 \text{ ns}$$

$V_{RSM}$	$V_{RRM}$	Type
V	V	
640	600	DSEI 8-06A
640	600	DSEI 8-06AS

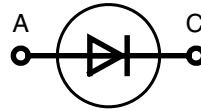
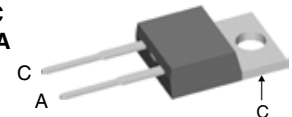
**TO-220 AC**  
**DSEI 8-06A**

**TO-263 AB**  
**DSEI 8-06AS**

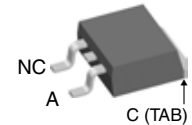
A = Anode, C = Cathode,  
 NC = No Connection,  
 TAB = Cathode



Symbol	Conditions	Maximum Ratings	
$I_{FRMS}$	$T_{VJ} = T_{VJM}$	16	A
$I_{FAVM}$ ①	$T_C = 115^\circ\text{C}$ ; rectangular, $d = 0.5$	8	A
$I_{FRM}$	$t_p < 10 \mu\text{s}$ ; rep. rating, pulse width limited by $T_{VJM}$	130	A
$I_{FSM}$	$T_{VJ} = 45^\circ\text{C}$ ; $t = 10 \text{ ms}$ (50 Hz), sine $t = 8.3 \text{ ms}$ (60 Hz), sine	100	A
		110	A
	$T_{VJ} = 150^\circ\text{C}$ ; $t = 10 \text{ ms}$ (50 Hz), sine $t = 8.3 \text{ ms}$ (60 Hz), sine	85	A
		95	A
$I^2t$	$T_{VJ} = 45^\circ\text{C}$ ; $t = 10 \text{ ms}$ (50 Hz), sine $t = 8.3 \text{ ms}$ (60 Hz), sine	50	$\text{A}^2\text{s}$
		50	$\text{A}^2\text{s}$
	$T_{VJ} = 150^\circ\text{C}$ ; $t = 10 \text{ ms}$ (50 Hz), sine $t = 8.3 \text{ ms}$ (60 Hz), sine	36	$\text{A}^2\text{s}$
		37	$\text{A}^2\text{s}$
$T_{VJ}$		-40...+150	$^\circ\text{C}$
$T_{VJM}$		150	$^\circ\text{C}$
$T_{stg}$		-40...+150	$^\circ\text{C}$
$P_{tot}$	$T_C = 25^\circ\text{C}$	50	W
$M_d$	mounting torque	0.4...0.6	Nm
Weight	typical	2	g

### Features

- International standard package JEDEC TO-220 AC & TO-283 AB
- Planar passivated chips
- Very short recovery time
- Extremely low switching losses
- Low  $I_{RM}$ -values
- Soft recovery behaviour
- Epoxy meets UL 94V-0

### Applications

- Antiparallel diode for high frequency switching devices
- Anti saturation diode
- Snubber diode
- Free wheeling diode in converters and motor control circuits
- Rectifiers in switch mode power supplies (SMPS)
- Inductive heating and melting
- Uninterruptible power supplies (UPS)
- Ultrasonic cleaners and welders

### Advantages

- High reliability circuit operation
- Low voltage peaks for reduced protection circuits
- Low noise switching
- Low losses
- Operating at lower temperature or space saving by reduced cooling

Symbol	Conditions	Characteristic Values		
		typ.	max.	
$I_R$	$V_R = V_{RRM}$ $T_{VJ} = 25^\circ\text{C}$		20	$\mu\text{A}$
	$V_R = 0.8 \cdot V_{RRM}$ $T_{VJ} = 25^\circ\text{C}$		10	$\mu\text{A}$
	$V_R = 0.8 \cdot V_{RRM}$ $T_{VJ} = 125^\circ\text{C}$		1.5	mA
$V_F$	$I_F = 8 \text{ A}$ $T_{VJ} = 150^\circ\text{C}$ $T_{VJ} = 25^\circ\text{C}$		1.3	V
			1.5	V
$V_{T0}$	For power-loss calculations only		0.98	V
$r_T$	$T_{VJ} = T_{VJM}$		28.7	$\text{m}\Omega$
$R_{thJC}$ $R_{thCH}$ $R_{thJA}$			2.5	K/W
		0.5	60	K/W
			60	K/W
$t_{rr}$	$I_F = 1 \text{ A}$ ; $-di/dt = 50 \text{ A}/\mu\text{s}$ ; $V_R = 30 \text{ V}$ ; $T_{VJ} = 25^\circ\text{C}$	35	50	ns
$I_{RM}$	$V_R = 350 \text{ V}$ ; $I_F = 8 \text{ A}$ ; $-di_F/dt = 64 \text{ A}/\mu\text{s}$ $L \leq 0.05 \mu\text{H}$ ; $T_{VJ} = 100^\circ\text{C}$	2.5	2.8	A

①  $I_{FAVM}$  rating includes reverse blocking losses at  $T_{VJM}$ ,  $V_R = 0.8 \cdot V_{RRM}$ , duty cycle  $d = 0.5$   
 Data according to IEC 60747

IXYS reserves the right to change limits, test conditions and dimensions.

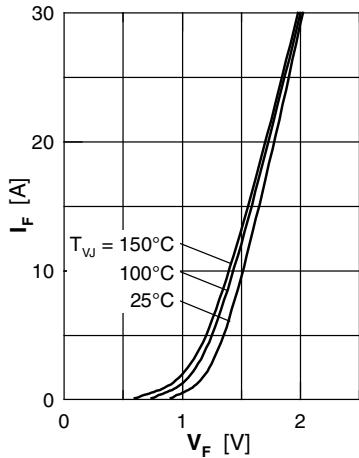

Fig. 1 Forward current versus voltage drop

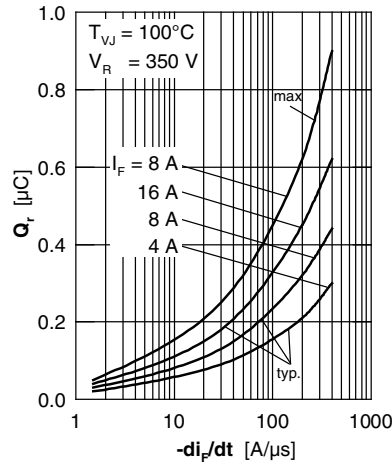

Fig. 2 Recovery charge versus  $-di_F/dt$

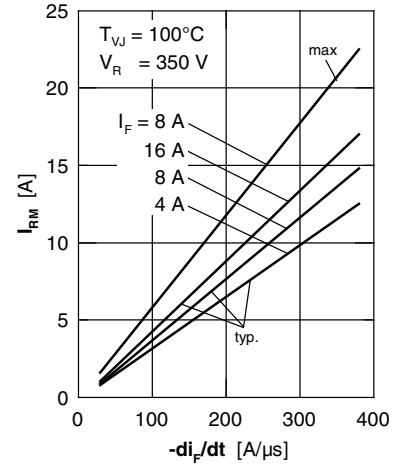

Fig. 3 Peak reverse current versus  $-di_F/dt$

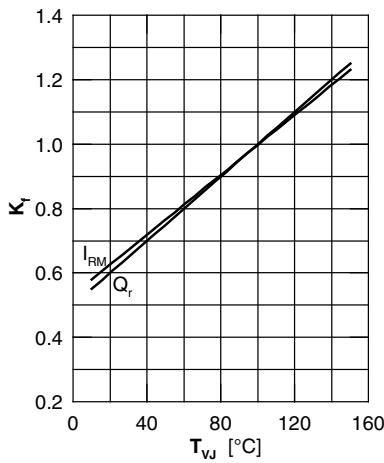

Fig. 4 Dynamic parameters versus junction temperature

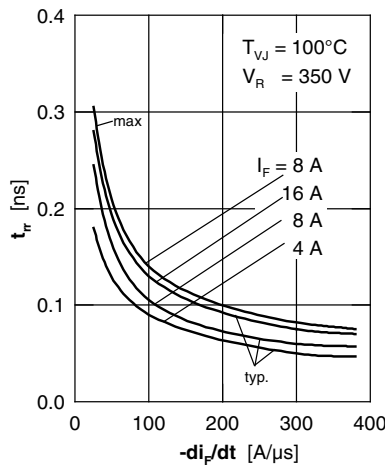

Fig. 5 Recovery time versus  $-di_F/dt$

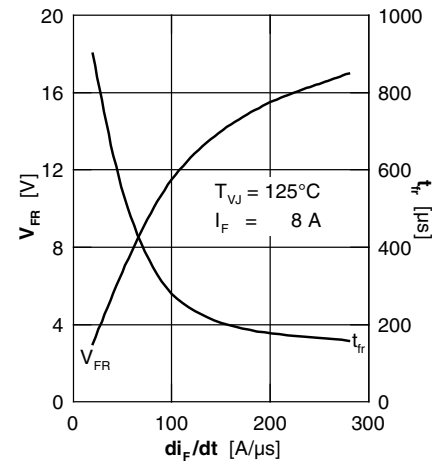

Fig. 6 Peak forward voltage versus  $di_F/dt$

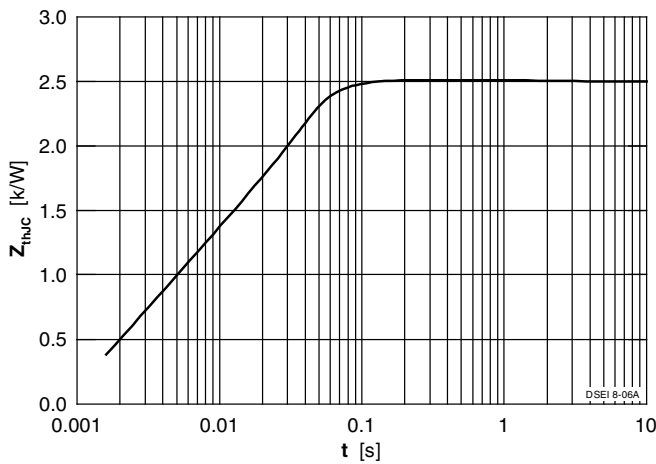

Fig. 7 Transient thermal resistance junction to case

IXYS reserves the right to change limits, test conditions and dimensions.

© 2009 IXYS All rights reserved

20090106a

## Dimensions TO-220 AC

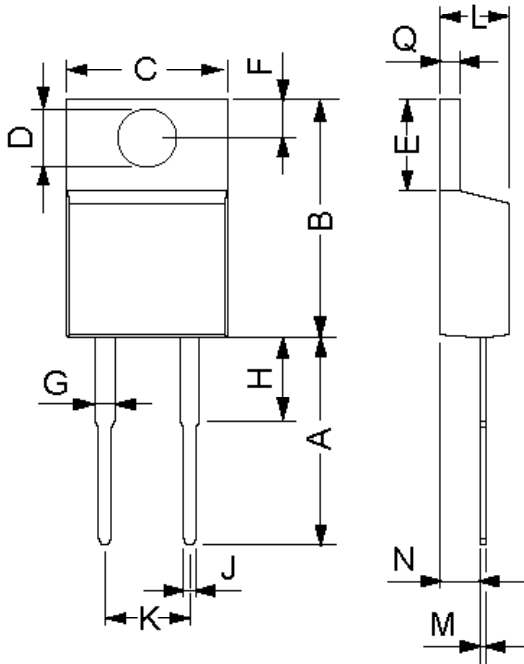

Dim.	Millimeter		Inches	
	Min.	Max.	Min.	Max.
A	12.7	14.73	0.5	0.58
B	14.23	16.51	0.56	0.65
C	9.66	10.66	0.38	0.42
D	3.54	4.08	0.139	0.161
E	5.85	6.85	2.3	0.42
F	2.54	3.42	0.1	0.135
G	1.15	1.77	0.045	0.07
H	-	6.35	-	0.25
J	0.64	0.89	0.025	0.035
K	4.83	5.33	0.19	0.21
L	3.56	4.82	0.14	0.19
M	0.51	0.76	0.02	0.03
N	2.04	2.49	0.08	0.115
Q	0.64	1.39	0.025	0.055

## Dimensions TO-263 AB

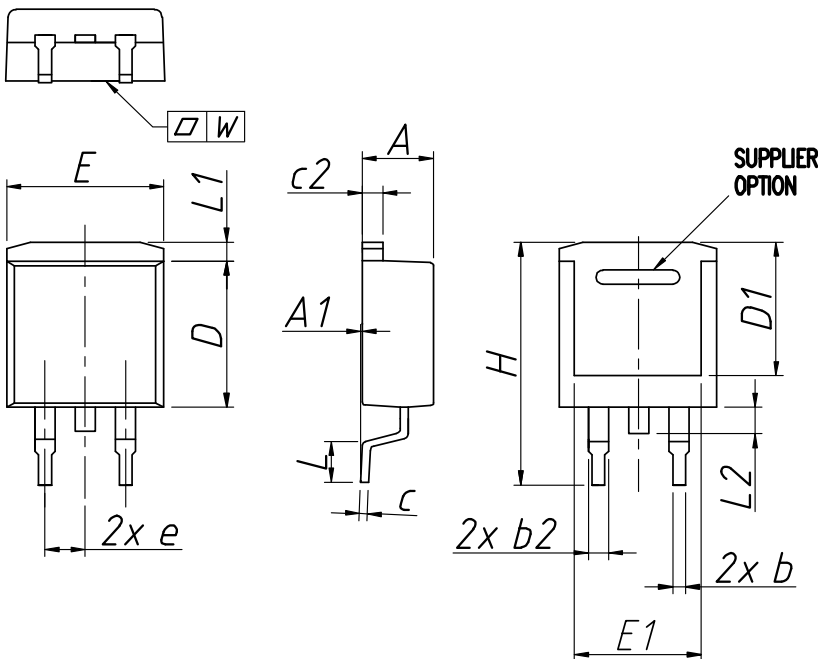

Dim.	Millimeter		Inches	
	min	max	min	max
A	4.06	4.83	0.160	0.190
A1	typ. 0.10		typ. 0.004	
b	0.51	0.99	0.020	0.039
b2	1.14	1.40	0.045	0.055
c	0.40	0.74	0.016	0.029
c2	1.14	1.40	0.045	0.029
D	8.38	9.40	0.330	0.370
D1	8.00	8.89	0.315	0.350
E	9.65	10.41	0.380	0.410
E1	6.22	8.13	0.245	0.320
e	2,54 BSC		0,100 BSC	
H	14.61	15.88	0.575	0.625
L	1.78	2.79	0.070	0.110
L1	1.02	1.68	0.040	0.066
L2	1.02	1.52	0.040	0.060
W	typ. 0.02	0.040	typ. 0.0008	0.0016

All dimensions conform with and/or are within JEDEC standard.

IXYS reserves the right to change limits, test conditions and dimensions.

© 2009 IXYS All rights reserved

20090106a