

BYV29B-600

Rectifier diode ultrafast

Rev. 01 — 11 August 2003

Product data

1. Product profile

1.1 Description

Ultra-fast, epitaxial rectifier diode in a surface mount plastic package.

Product availability:

BYV29B-600 in SOT404 (D²-PAK).

1.2 Features

- Low forward voltage
- Soft recovery characteristic
- Fast switching
- High thermal cycling performance.

1.3 Applications

- Switched-mode power supplies
- Low loss rectification.

1.4 Quick reference data

- $V_R \leq 600$ V
- $I_{F(AV)} \leq 9$ A
- $V_F \leq 1.03$ V
- $t_{rr} \leq 60$ ns

2. Pinning information

Table 1: Pinning - SOT404 (D²-PAK), simplified outline and symbol

Pin	Description	Simplified outline	Symbol
1	no connection		
2	cathode (k) [1]		
3	anode (a)		
mb	mounting base; connected to cathode (k)		

SOT404 (D²-PAK)

[1] It is not possible to make connection to pin 2 of the SOT404 package.



PHILIPS

3. Ordering information

Table 2: Ordering information

Type number	Package		Version
	Name	Description	
BYV29B-600	D ² -PAK	Plastic single-ended surface mounted package; 3 leads (one lead cropped)	SOT404

4. Limiting values

Table 3: Limiting values

In accordance with the Absolute Maximum Rating System (IEC 60134).

Symbol	Parameter	Conditions	Min	Max	Unit
V_{RRM}	repetitive peak reverse voltage		-	600	V
V_{RWM}	crest working reverse voltage		-	600	V
V_R	reverse voltage		-	600	V
$I_{F(AV)}$	average forward current	square wave; $\delta = 0.5$; $T_{mb} \leq 120$ °C	[1]	9	A
I_{FRM}	repetitive peak forward current	square wave; $t = 25$ μ s; $\delta = 0.5$; $T_{mb} \leq 120$ °C	-	18	A
I_{FSM}	non-repetitive peak forward current	sinusoidal; with reapplied $V_{RRM(max)}$			
		$t_p = 10$ ms	-	70	A
		$t_p = 8.3$ ms	-	77	A
T_{stg}	storage temperature		-40	+150	°C
T_j	junction temperature		-	+150	°C

[1] Neglecting switching and reverse current losses.

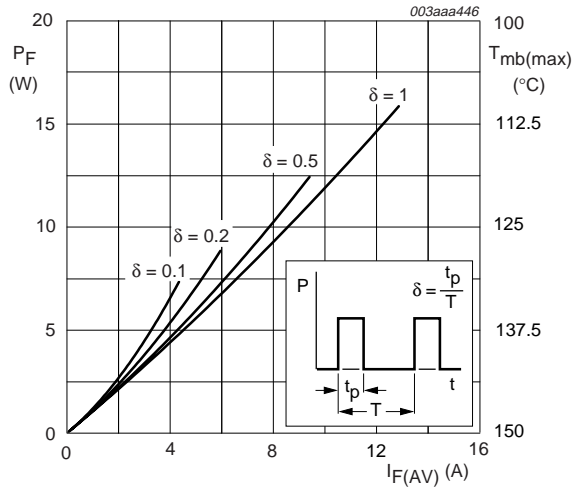

Square current waveform

$$I_{F(AV)} = I_{F(RMS)} \times \sqrt{\delta}$$

Fig 1. Maximum forward power dissipation (square current waveform) as a function of average forward current.

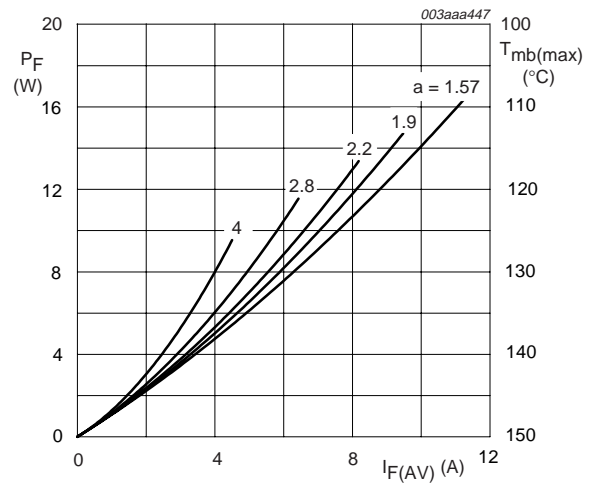

Sinusoidal current waveform

$$a = \frac{I_{F(RMS)}}{I_{F(AV)}}$$

Fig 2. Maximum forward power dissipation (sinusoidal current waveform) as a function of average forward current.

5. Thermal characteristics

Table 4: Thermal characteristics

Symbol	Parameter	Conditions	Min	Typ	Max	Unit
$R_{th(j-mb)}$	thermal resistance from junction to mounting base	Figure 3	-	-	2.5	K/W
$R_{th(j-a)}$	thermal resistance from junction to ambient	in free air	-	50	-	K/W

5.1 Transient thermal impedance

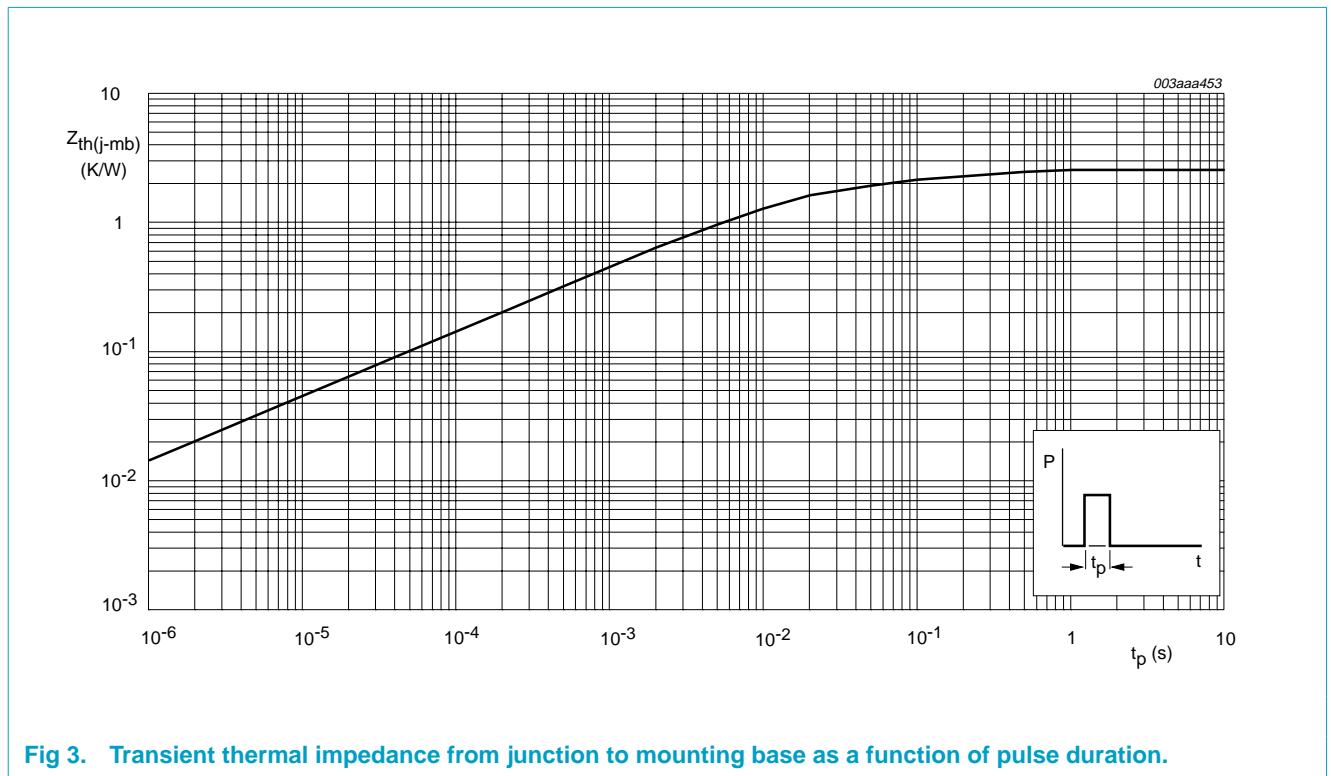

Fig 3. Transient thermal impedance from junction to mounting base as a function of pulse duration.

6. Characteristics

Table 5: Characteristics

$T_j = 25\text{ °C}$ unless otherwise specified.

Symbol	Parameter	Conditions	Min	Typ	Max	Unit
Static characteristics						
V_F	forward voltage	$I_F = 8\text{ A}$				
		$T_j = 150\text{ °C}$; Figure 4	-	0.9	1.03	V
		$T_j = 25\text{ °C}$; Figure 4	-	1.05	1.25	V
I_R	reverse current	$I_F = 20\text{ A}$	-	1.3	1.45	V
		$V_R = V_{RRM}$				
		$T_j = 100\text{ °C}$	-	0.1	0.35	mA
		$T_j = 25\text{ °C}$	-	2	50	μA
Dynamic characteristics						
C_d	diode capacitance	$f = 1\text{ MHz}$; $V_R = 100\text{ V}$; Figure 8	-	7	-	pF
Q_{rr}	reverse recovery charge	$I_F = 2\text{ A}$; $V_R \geq 30\text{ V}$; $dI_F/dt = 20\text{ A}/\mu\text{s}$; Figure 7	-	40	70	nC
t_{rr}	reverse recovery time	$I_F = 1\text{ A}$; $V_R \geq 30\text{ V}$; $dI_F/dt = 100\text{ A}/\mu\text{s}$; Figure 5	-	50	60	ns
I_{rrm}	peak reverse recovery current	$I_F = 10\text{ A}$; $V_R \geq 30\text{ V}$; $dI_F/dt = 50\text{ A}/\mu\text{s}$; $T_j = 100\text{ °C}$; Figure 6	-	3	5.5	A
V_{fr}	forward recovery voltage	$I_F = 10\text{ A}$; $dI_F/dt = 10\text{ A}/\mu\text{s}$	-	3.2	-	V

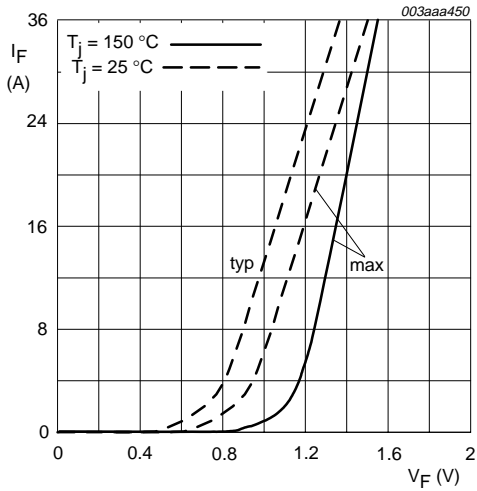

Fig 4. Forward current as a function of forward voltage; typical values.

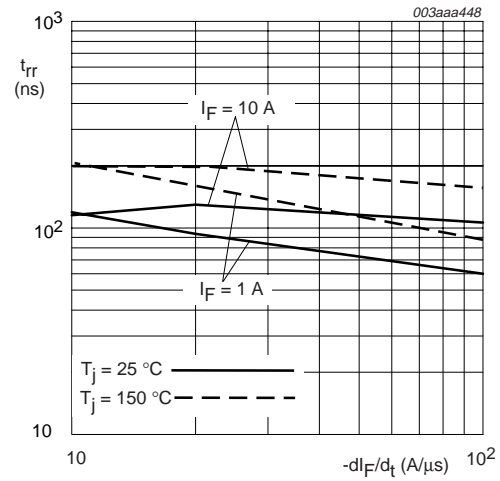

Fig 5. Maximum reverse recovery time as a function of rate of change of forward current.

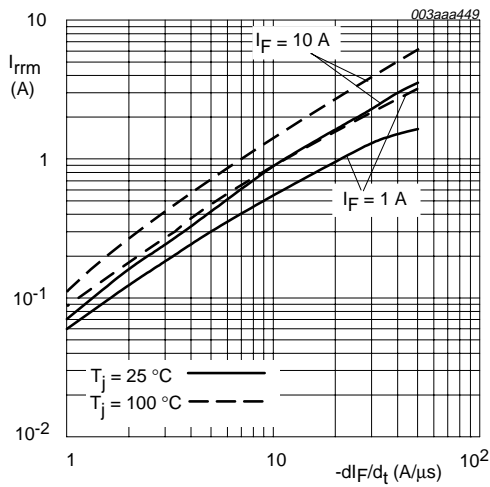

Fig 6. Reverse current as a function of rate of change of forward current; typical values.

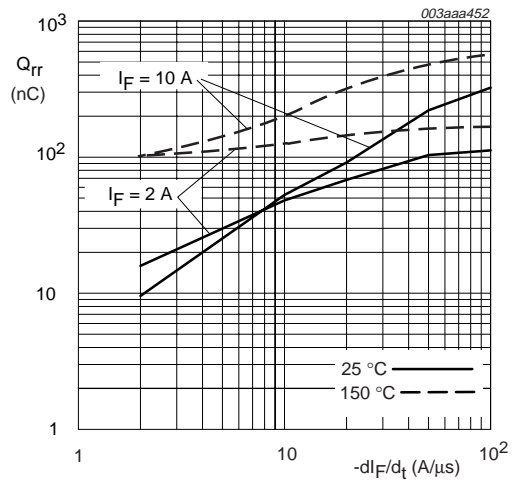
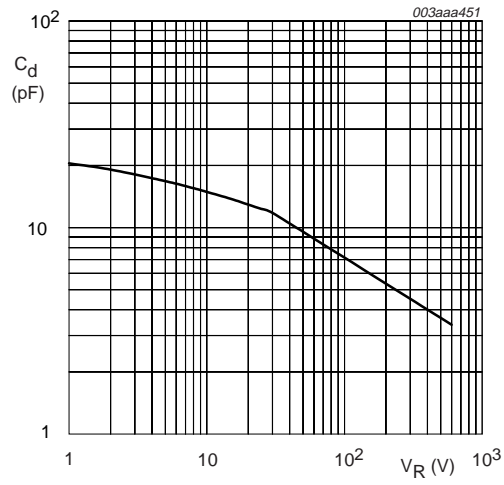

Fig 7. Maximum reverse recovery charge as a function of rate of change of forward current.



f = 1MHz

Fig 8. Diode capacitance as a function of reverse voltage; typical values.

7. Package outline

Plastic single-ended surface mounted package (Philips version of D²-PAK); 3 leads (one lead cropped)

SOT404

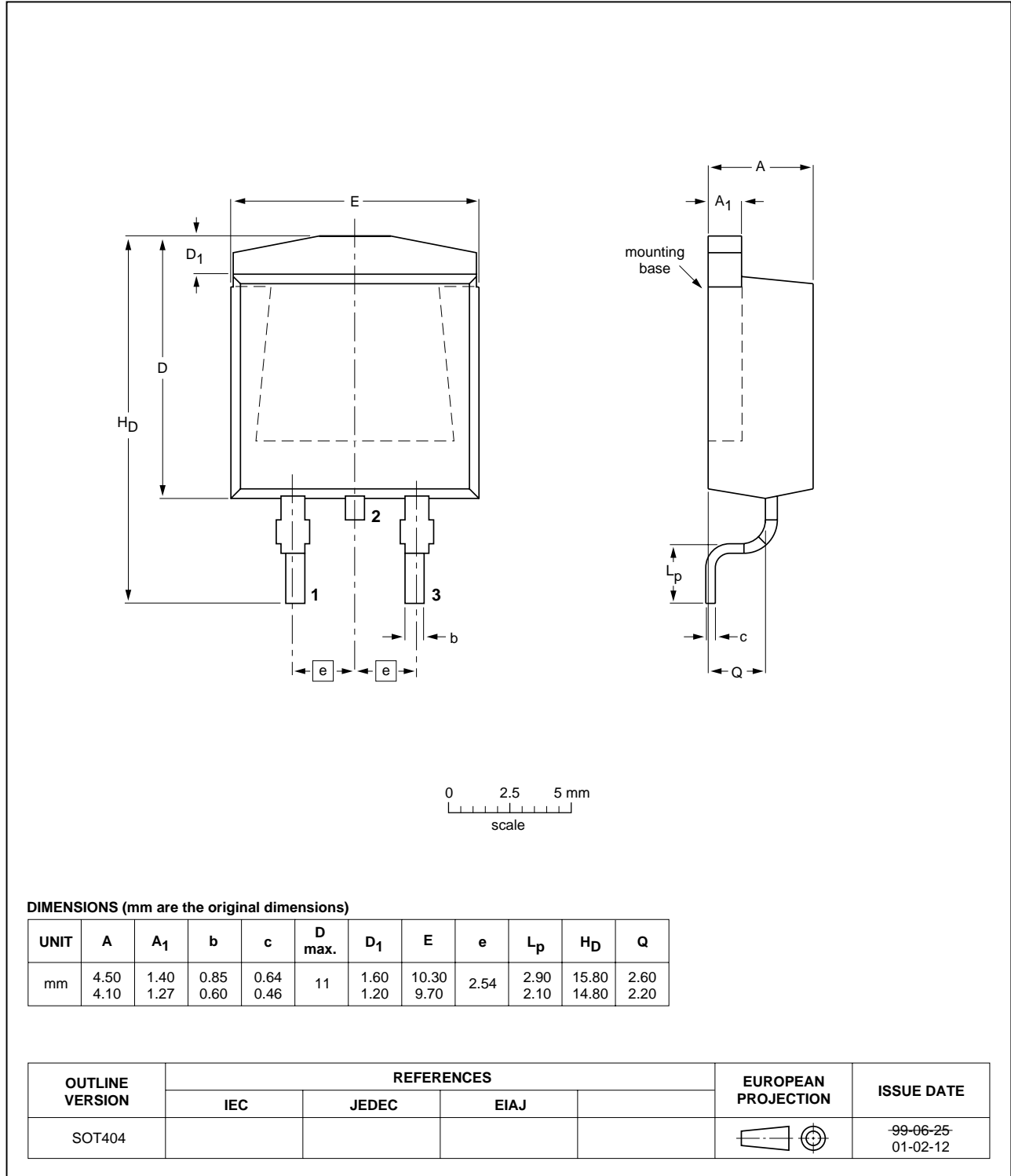
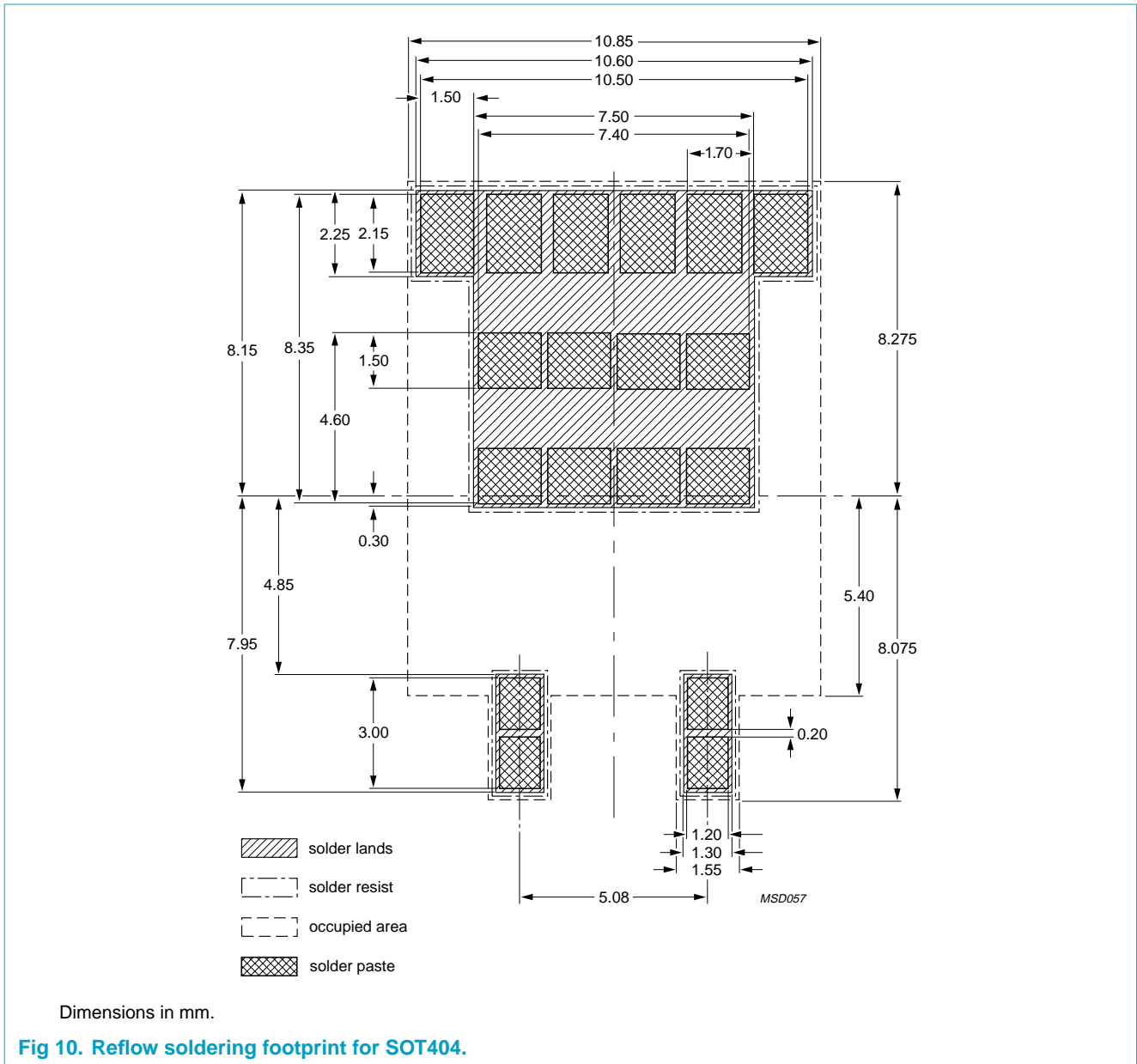

Fig 9. SOT404 (D²-PAK).

8. Soldering



9. Revision history

Table 6: Revision history

Rev	Date	CPCN	Description
01	20030811	-	Product data (9397 750 11884).

10. Data sheet status

Level	Data sheet status ^[1]	Product status ^{[2][3]}	Definition
I	Objective data	Development	This data sheet contains data from the objective specification for product development. Philips Semiconductors reserves the right to change the specification in any manner without notice.
II	Preliminary data	Qualification	This data sheet contains data from the preliminary specification. Supplementary data will be published at a later date. Philips Semiconductors reserves the right to change the specification without notice, in order to improve the design and supply the best possible product.
III	Product data	Production	This data sheet contains data from the product specification. Philips Semiconductors reserves the right to make changes at any time in order to improve the design, manufacturing and supply. Relevant changes will be communicated via a Customer Product/Process Change Notification (CPCN).

[1] Please consult the most recently issued data sheet before initiating or completing a design.

[2] The product status of the device(s) described in this data sheet may have changed since this data sheet was published. The latest information is available on the Internet at URL <http://www.semiconductors.philips.com>.

[3] For data sheets describing multiple type numbers, the highest-level product status determines the data sheet status.

11. Definitions

Short-form specification — The data in a short-form specification is extracted from a full data sheet with the same type number and title. For detailed information see the relevant data sheet or data handbook.

Limiting values definition — Limiting values given are in accordance with the Absolute Maximum Rating System (IEC 60134). Stress above one or more of the limiting values may cause permanent damage to the device. These are stress ratings only and operation of the device at these or at any other conditions above those given in the Characteristics sections of the specification is not implied. Exposure to limiting values for extended periods may affect device reliability.

Application information — Applications that are described herein for any of these products are for illustrative purposes only. Philips Semiconductors make no representation or warranty that such applications will be suitable for the specified use without further testing or modification.

12. Disclaimers

Life support — These products are not designed for use in life support appliances, devices, or systems where malfunction of these products can reasonably be expected to result in personal injury. Philips Semiconductors customers using or selling these products for use in such applications do so at their own risk and agree to fully indemnify Philips Semiconductors for any damages resulting from such application.

Right to make changes — Philips Semiconductors reserves the right to make changes in the products - including circuits, standard cells, and/or software - described or contained herein in order to improve design and/or performance. When the product is in full production (status 'Production'), relevant changes will be communicated via a Customer Product/Process Change Notification (CPCN). Philips Semiconductors assumes no responsibility or liability for the use of any of these products, conveys no licence or title under any patent, copyright, or mask work right to these products, and makes no representations or warranties that these products are free from patent, copyright, or mask work right infringement, unless otherwise specified.

Contact information

For additional information, please visit <http://www.semiconductors.philips.com>.

For sales office addresses, send e-mail to: sales.addresses@www.semiconductors.philips.com.

Fax: +31 40 27 24825

Contents

1	Product profile	1
1.1	Description	1
1.2	Features	1
1.3	Applications	1
1.4	Quick reference data	1
2	Pinning information	1
3	Ordering information	2
4	Limiting values	2
5	Thermal characteristics	4
5.1	Transient thermal impedance	4
6	Characteristics	5
7	Package outline	8
8	Soldering	9
9	Revision history	10
10	Data sheet status	11
11	Definitions	11
12	Disclaimers	11

© Koninklijke Philips Electronics N.V. 2003.
Printed in The Netherlands

All rights are reserved. Reproduction in whole or in part is prohibited without the prior written consent of the copyright owner.

The information presented in this document does not form part of any quotation or contract, is believed to be accurate and reliable and may be changed without notice. No liability will be accepted by the publisher for any consequence of its use. Publication thereof does not convey nor imply any license under patent- or other industrial or intellectual property rights.

Date of release: 11 August 2003

Document order number: 9397 750 11884



PHILIPS

Let's make things better.