

**Rectifier diodes
ultrafast, rugged**

BYW29EB, BYW29ED series

FEATURES

- Low forward volt drop
- Fast switching
- Soft recovery characteristic
- Reverse surge capability
- High thermal cycling performance
- Low thermal resistance

SYMBOL

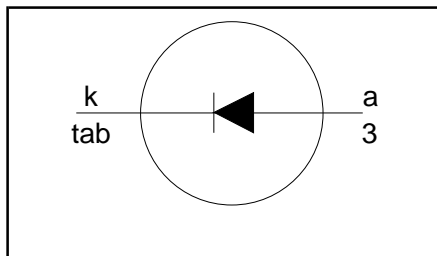

QUICK REFERENCE DATA

$V_R = 150\text{ V} / 200\text{ V}$
$V_F \leq 0.895\text{ V}$
$I_{F(AV)} = 8\text{ A}$
$I_{RRM} = 0.2\text{ A}$
$t_{tr} \leq 25\text{ ns}$

GENERAL DESCRIPTION

Ultra-fast, epitaxial rectifier diodes intended for use as output rectifiers in high frequency switched mode power supplies.

The BYW29EB series is supplied in the SOT404 surface mounting package.
The BYW29ED series is supplied in the SOT428 surface mounting package.

PINNING

PIN	DESCRIPTION
1	no connection
2	cathode ¹
3	anode
tab	cathode

SOT404

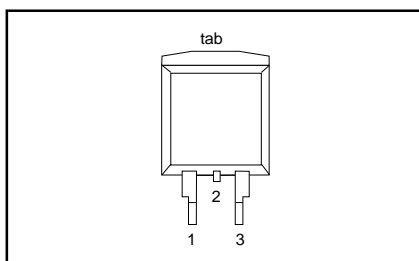

SOT428

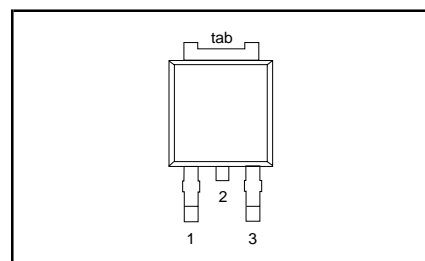

LIMITING VALUES

Limiting values in accordance with the Absolute Maximum System (IEC 134)

SYMBOL	PARAMETER	CONDITIONS	MIN.	MAX.		UNIT
V_{RRM}	Peak repetitive reverse voltage	BYW29EB/ BYW29ED	-	-150	-200	V
V_{RWM}	Working peak reverse voltage		-	150	200	V
V_R	Continuous reverse voltage		-	150	200	V
$I_{F(AV)}$	Average rectified forward current	square wave; $\delta = 0.5$; $T_{mb} \leq 128\text{ }^\circ\text{C}$	-	8		A
I_{FRM}	Repetitive peak forward current	square wave; $\delta = 0.5$; $T_{mb} \leq 128\text{ }^\circ\text{C}$	-	16		A
I_{FSM}	Non-repetitive peak forward current	$t = 10\text{ ms}$	-	80		A
		$t = 8.3\text{ ms}$	-	88		A
I_{RRM}	Peak repetitive reverse surge current	sinusoidal; with reapplied $V_{RRM(max)}$ $t_p = 2\text{ }\mu\text{s}$; $\delta = 0.001$	-	0.2		A
I_{RSM}	Peak non-repetitive reverse surge current	$t_p = 100\text{ }\mu\text{s}$	-	0.2		A
T_j	Operating junction temperature		-	150		$^\circ\text{C}$
T_{stg}	Storage temperature		- 40	150		$^\circ\text{C}$

1. It is not possible to make connection to pin 2 of the SOT428 or SOT404 packages.

**Rectifier diodes
ultrafast, rugged**
BYW29EB, BYW29ED series
ESD LIMITING VALUE

SYMBOL	PARAMETER	CONDITIONS	MIN.	MAX.	UNIT
V_C	Electrostatic discharge capacitor voltage	Human body model; $C = 250 \text{ pF}$; $R = 1.5 \text{ k}\Omega$	-	8	kV

THERMAL RESISTANCES

SYMBOL	PARAMETER	CONDITIONS	MIN.	TYP.	MAX.	UNIT
$R_{th \text{ j-mb}}$	Thermal resistance junction to mounting base	SOT404 and SOT428 packages, pcb mounted, minimum footprint, FR4 board	-	-	2.7	K/W
$R_{th \text{ j-a}}$	Thermal resistance junction to ambient		-	50	-	K/W

ELECTRICAL CHARACTERISTICS
 $T_j = 25 \text{ }^\circ\text{C}$ unless otherwise specified

SYMBOL	PARAMETER	CONDITIONS	MIN.	TYP.	MAX.	UNIT
V_F	Forward voltage	$I_F = 8 \text{ A}$; $T_j = 150^\circ\text{C}$	-	0.8	0.895	V
		$I_F = 8 \text{ A}$	-	0.92	1.05	V
		$I_F = 20 \text{ A}$	-	1.1	1.3	V
I_R	Reverse current	$V_R = V_{RWM}$	-	2	10	μA
		$V_R = V_{RWM}$; $T_j = 100^\circ\text{C}$	-	0.2	0.6	mA
Q_{rr}	Reverse recovered charge	$I_F = 2 \text{ A}$; $V_R \geq 30 \text{ V}$; $-di_F/dt = 20 \text{ A}/\mu\text{s}$	-	4	11	nC
t_{rr1}	Reverse recovery time	$I_F = 1 \text{ A}$; $V_R \geq 30 \text{ V}$; $-di_F/dt = 100 \text{ A}/\mu\text{s}$	-	20	25	ns
t_{rr2}	Reverse recovery time	$I_F = 0.5 \text{ A}$ to $I_R = 1 \text{ A}$; $I_{rec} = 0.25 \text{ A}$	-	15	20	ns
V_{fr}	Forward recovery voltage	$I_F = 1 \text{ A}$; $di_F/dt = 10 \text{ A}/\mu\text{s}$	-	1	-	V

Rectifier diodes
ultrafast, rugged

BYW29EB, BYW29ED series

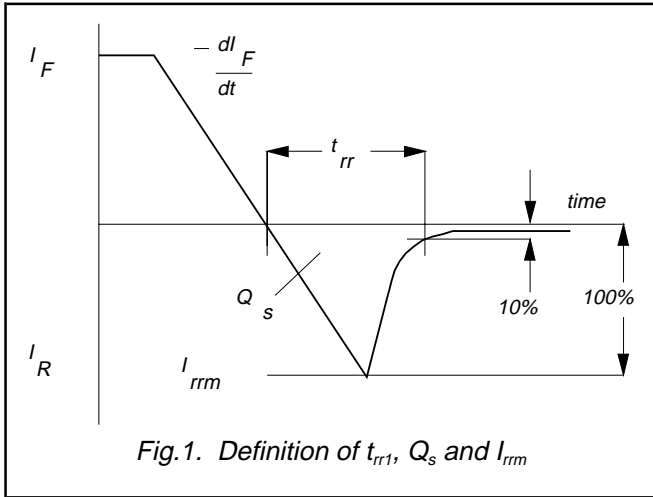

Fig.1. Definition of t_{rr1} , Q_s and I_{rm}

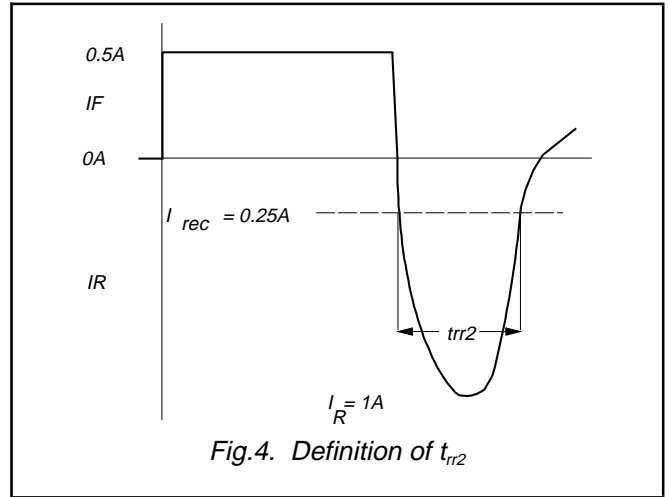

Fig.4. Definition of t_{rr2}

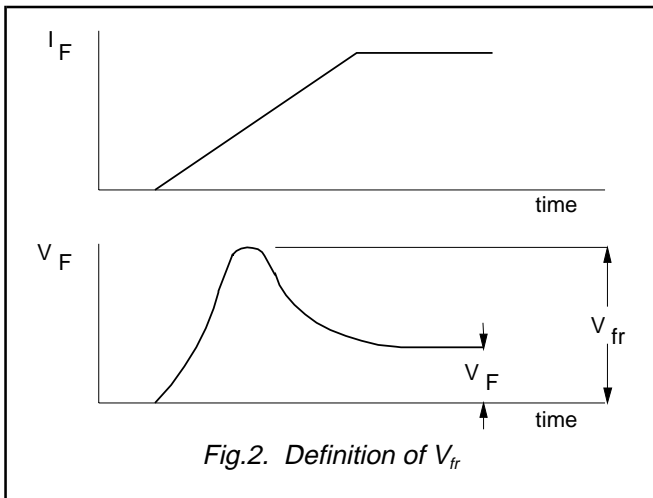

Fig.2. Definition of V_{fr}

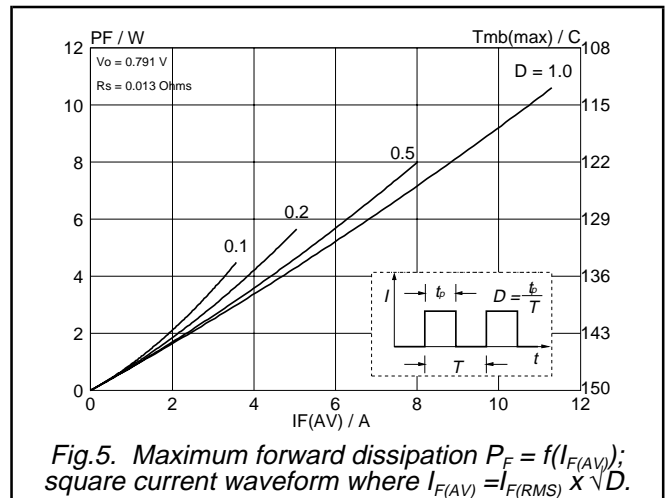

Fig.5. Maximum forward dissipation $P_F = f(I_{F(AV)})$; square current waveform where $I_{F(AV)} = I_{F(RMS)} \times \sqrt{D}$.

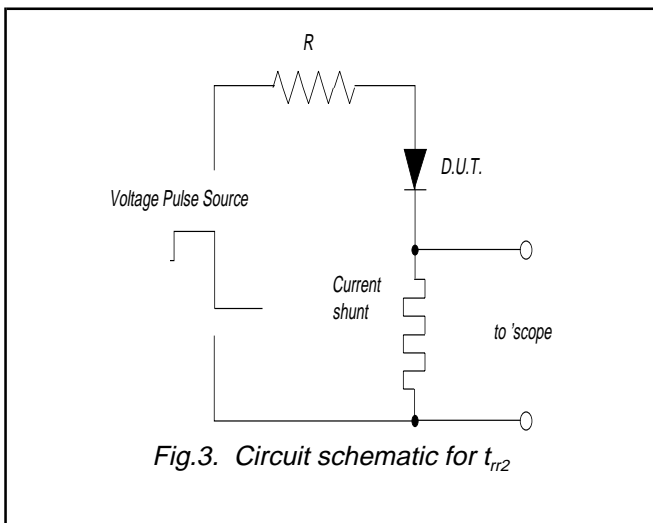

Fig.3. Circuit schematic for t_{rr2}

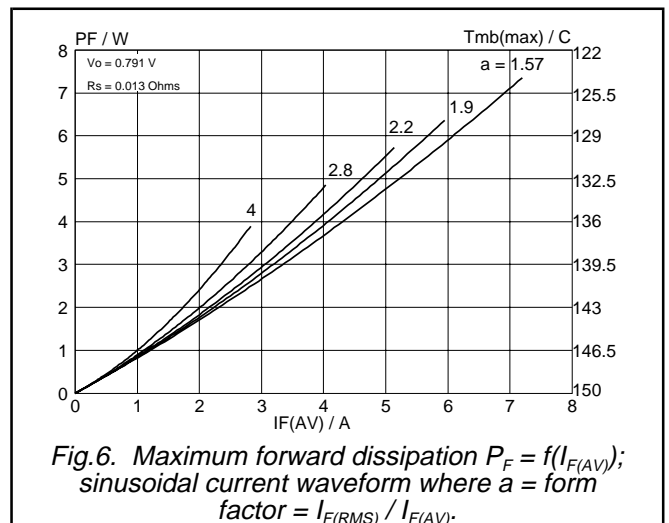
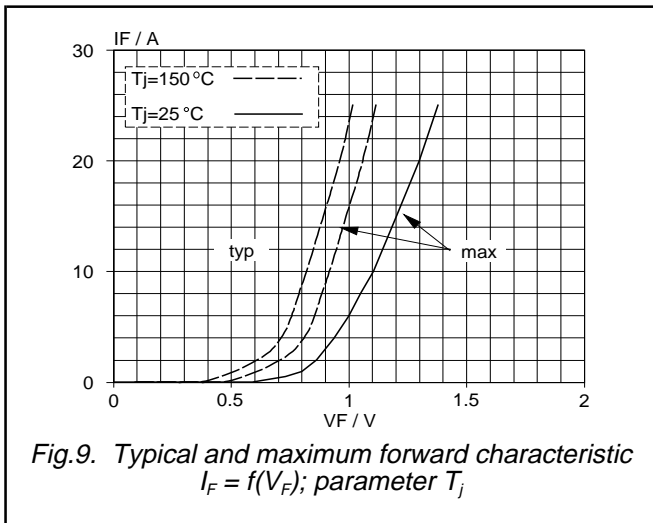
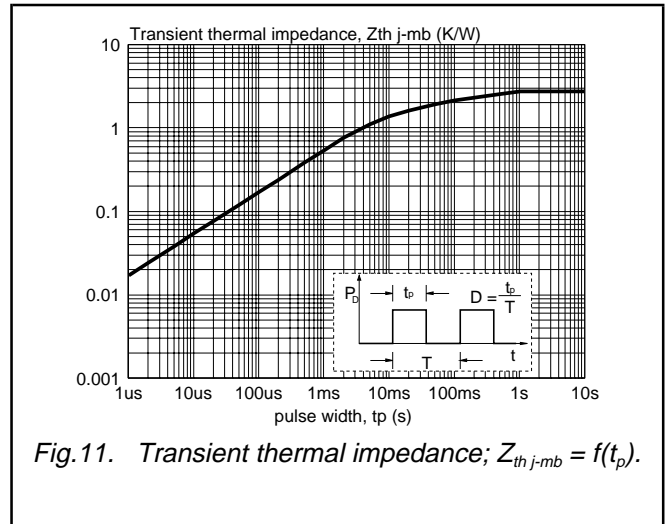
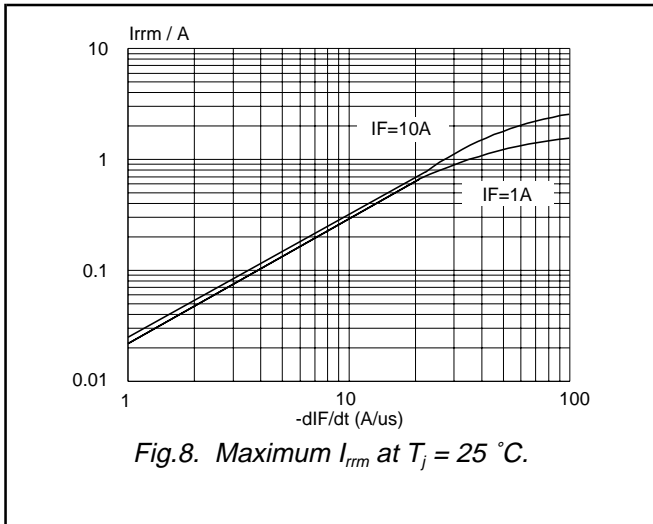
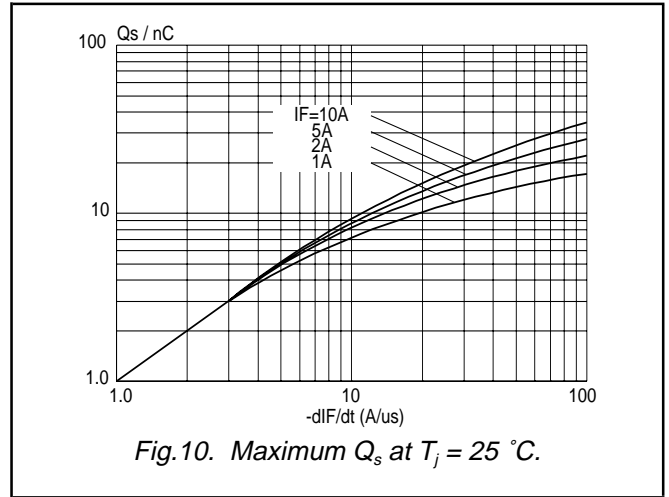
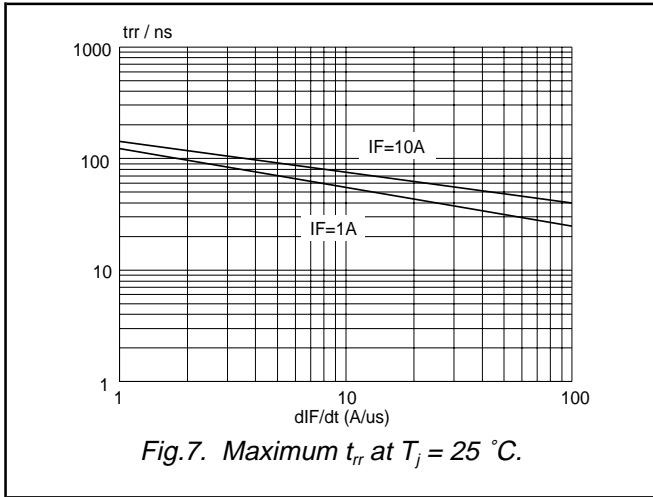

Fig.6. Maximum forward dissipation $P_F = f(I_{F(AV)})$; sinusoidal current waveform where $a = \text{form factor} = I_{F(RMS)} / I_{F(AV)}$.

Rectifier diodes
ultrafast, rugged

BYW29EB, BYW29ED series



Rectifier diodes
ultrafast, rugged

BYW29EB, BYW29ED series

MECHANICAL DATA

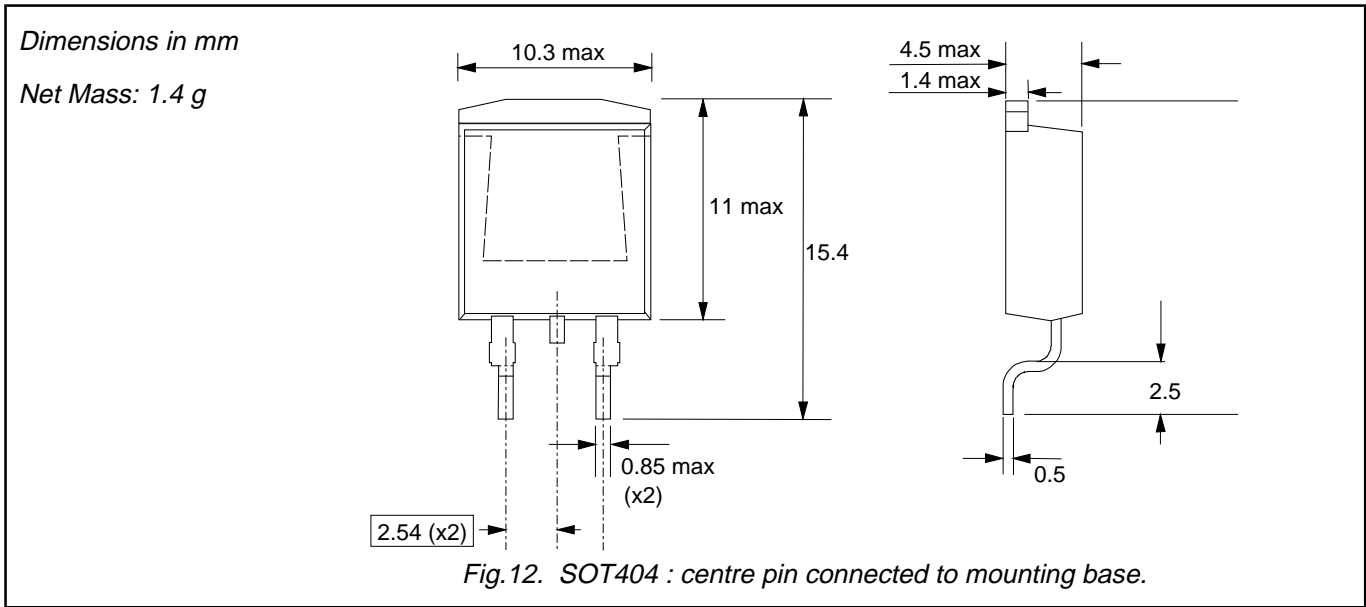

MOUNTING INSTRUCTIONS

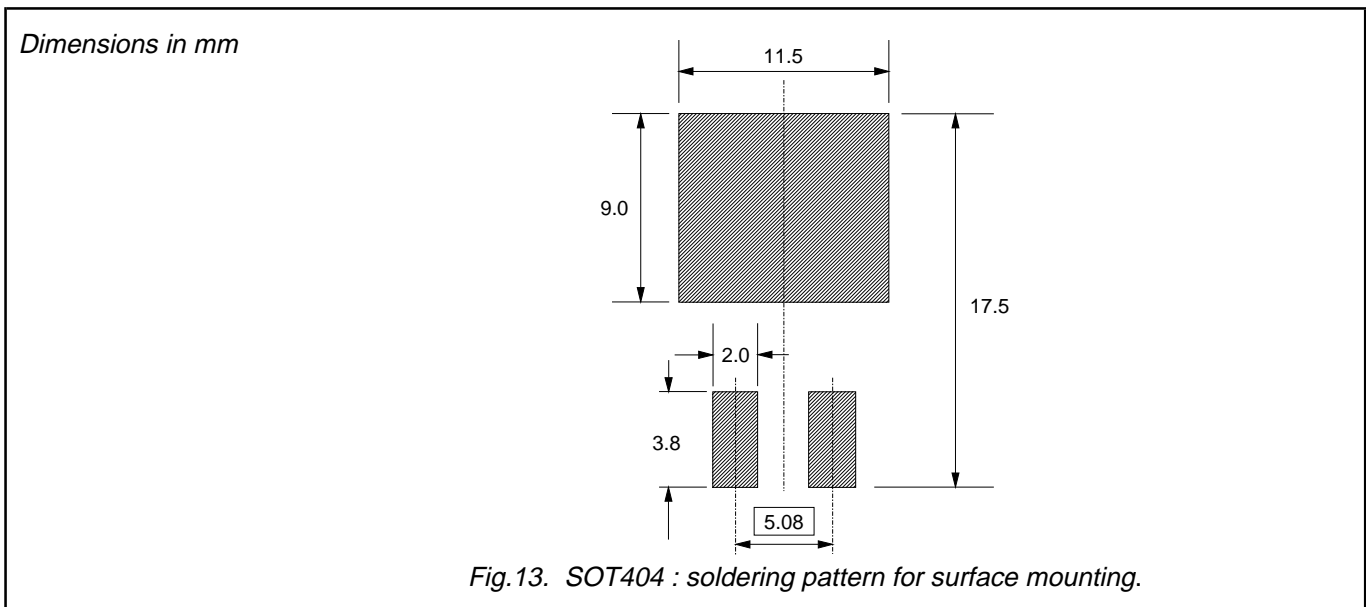

Notes

- 1. Epoxy meets UL94 V0 at 1/8".

Rectifier diodes
ultrafast, rugged

BYW29EB, BYW29ED series

MECHANICAL DATA

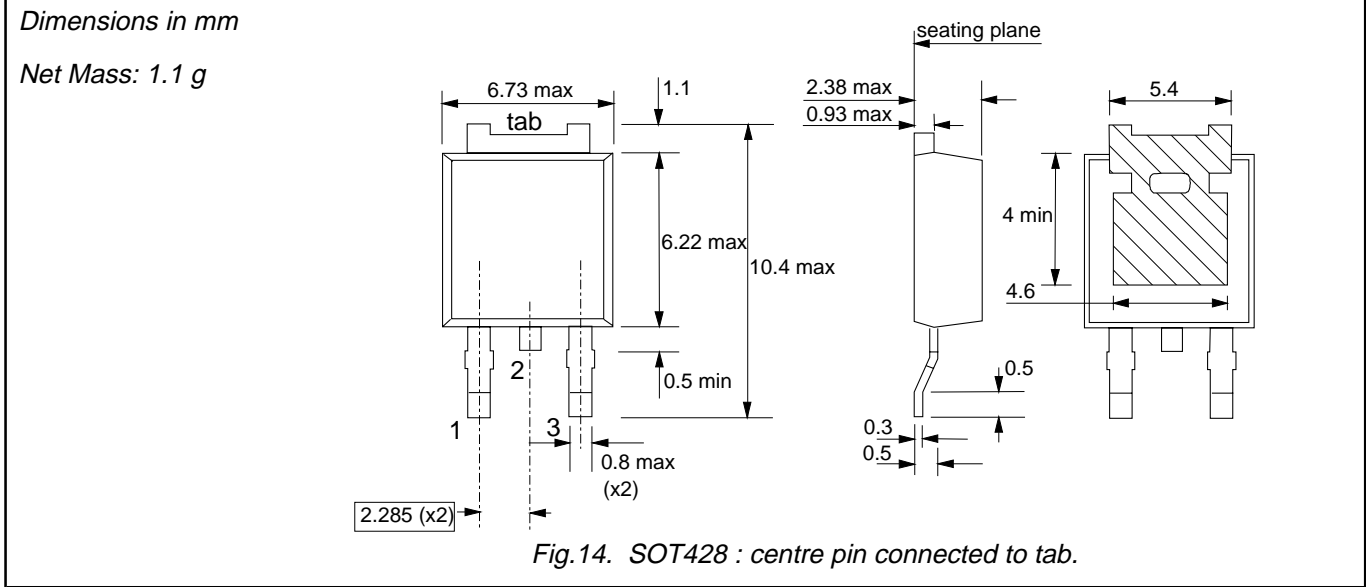

MOUNTING INSTRUCTIONS

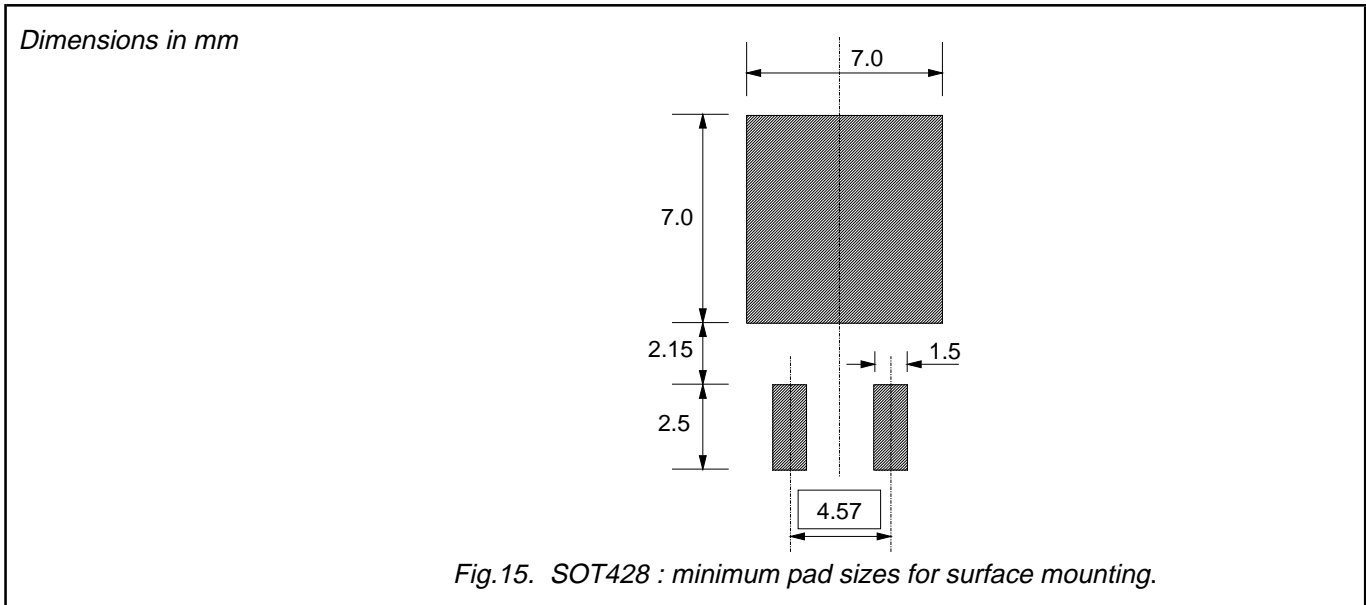

Notes

1. Plastic meets UL94 V0 at 1/8".

Rectifier diodes
ultrafast, rugged

BYW29EB, BYW29ED series

DEFINITIONS

Data sheet status	
Objective specification	This data sheet contains target or goal specifications for product development.
Preliminary specification	This data sheet contains preliminary data; supplementary data may be published later.
Product specification	This data sheet contains final product specifications.
Limiting values	
Limiting values are given in accordance with the Absolute Maximum Rating System (IEC 134). Stress above one or more of the limiting values may cause permanent damage to the device. These are stress ratings only and operation of the device at these or at any other conditions above those given in the Characteristics sections of this specification is not implied. Exposure to limiting values for extended periods may affect device reliability.	
Application information	
Where application information is given, it is advisory and does not form part of the specification.	
© Philips Electronics N.V. 1998	
All rights are reserved. Reproduction in whole or in part is prohibited without the prior written consent of the copyright owner.	
The information presented in this document does not form part of any quotation or contract, it is believed to be accurate and reliable and may be changed without notice. No liability will be accepted by the publisher for any consequence of its use. Publication thereof does not convey nor imply any license under patent or other industrial or intellectual property rights.	

LIFE SUPPORT APPLICATIONS

These products are not designed for use in life support appliances, devices or systems where malfunction of these products can be reasonably expected to result in personal injury. Philips customers using or selling these products for use in such applications do so at their own risk and agree to fully indemnify Philips for any damages resulting from such improper use or sale.

Rectifier diodes
ultrafast, rugged

BYW29EB, BYW29ED series

DEFINITIONS

Data sheet status	
Objective specification	This data sheet contains target or goal specifications for product development.
Preliminary specification	This data sheet contains preliminary data; supplementary data may be published later.
Product specification	This data sheet contains final product specifications.
Limiting values	
Limiting values are given in accordance with the Absolute Maximum Rating System (IEC 134). Stress above one or more of the limiting values may cause permanent damage to the device. These are stress ratings only and operation of the device at these or at any other conditions above those given in the Characteristics sections of this specification is not implied. Exposure to limiting values for extended periods may affect device reliability.	
Application information	
Where application information is given, it is advisory and does not form part of the specification.	
© Philips Electronics N.V. 1998	
All rights are reserved. Reproduction in whole or in part is prohibited without the prior written consent of the copyright owner.	
The information presented in this document does not form part of any quotation or contract, it is believed to be accurate and reliable and may be changed without notice. No liability will be accepted by the publisher for any consequence of its use. Publication thereof does not convey nor imply any license under patent or other industrial or intellectual property rights.	

LIFE SUPPORT APPLICATIONS

These products are not designed for use in life support appliances, devices or systems where malfunction of these products can be reasonably expected to result in personal injury. Philips customers using or selling these products for use in such applications do so at their own risk and agree to fully indemnify Philips for any damages resulting from such improper use or sale.