

# CRYSTAL CONTROLLED OSCILLATORS

## 3.3V SURFACE MOUNT 5.0 x 7.5mm LVDS CLOCK OSCILLATOR

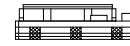
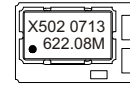

X502

### ABSOLUTE MAXIMUM RATINGS

TABLE 1.0

PARAMETER	UNITS	MINIMUM	NOMINAL	MAXIMUM	UNITS	NOTE
Storage Temperature		-55	-	125	°C	
Supply Voltage	(Vcc)	-0.5	-	4.6	Vdc	
Input Voltage		-0.5	-	Vcc+0.5	Vdc	

### OPERATING SPECIFICATIONS

TABLE 2.0

PARAMETER		MINIMUM	NOMINAL	MAXIMUM	UNITS	NOTE
Center Frequency	(Fo)	200	-	800	MHz	
Total Frequency Tolerance		-20	-	20	ppm	1
Operating Temperature Range		0	-	70	°C	
Supply Voltage	(Vcc)	3.135	3.3	3.465	Vdc	
Supply Current	(Icc)	-	-	100	mA	
Jitter (BW=10Hz to 20MHz)		-	-	10	ps rms	
Jitter (BW=12kHz to 80MHz)		-	-	2	ps rms	
SSB Phase Noise at 10Hz offset		-	-75	-	dBc/Hz	
SSB Phase Noise at 100Hz offset		-	-95	-	dBc/Hz	
SSB Phase Noise at 1KHz offset		-	-110	-	dBc/Hz	
SSB Phase Noise at 10KHz offset		-	-125	-	dBc/Hz	
SSB Phase Noise at 100KHz offset		-	-120	-	dBc/Hz	

### INPUT CHARACTERISTICS

TABLE 3.0

PARAMETER		MINIMUM	NOMINAL	MAXIMUM	UNITS	NOTE
Enable Input Voltage (Low)	(Vil)	-	-	0.3Vcc	Vdc	2
Disable Input Voltage (High)	(Vih)	0.7Vcc	-	-	Vdc	2

### LVDS OUTPUT CHARACTERISTICS

TABLE 4.0

PARAMETER		MINIMUM	NOMINAL	MAXIMUM	UNITS	NOTE
LOAD		-	-	100	Ohms	3
Output Differential Voltage	(Vod)	250	-	450	mV	
Duty Cycle at 50% Level		45	50	55	%	
Rise / Fall Time		-	0.6	1.0	nS	

### PACKAGE CHARACTERISTICS

TABLE 5.0

Package	Hermetically sealed ceramic package with grounded metal cover.
---------	--

### PROCESS RECOMMENDATIONS

TABLE 6.0

Solder Reflow	See solder profile on page 2.
---------------	-------------------------------

### Notes

- Includes initial tolerance, deviation over temperature, supply and load variations, shock, vibration and 10 years aging.
- When oscillator is disabled both output are in a high impedance state (Tri-State)
- Vod measured with 100 ohm resistor between the true output and the complementary output.

### DESCRIPTION

The Connor-Winfield X502 is a 3.3V Crystal Controlled Oscillator (XO) with LVDS differential outputs. The X502 is designed for use with PLL systems requiring tight frequency stability vs. change in temperature and high frequency output over the commercial temperature range. The X502 is designed using a 2x or 4x PLL multiplication to achieve the high frequency output.

### FEATURES

- 3.3V OPERATION
- LOW JITTER <2ps RMS
- TOTAL FREQUENCY TOLERANCE: ±20ppm
- TEMPERATURE RANGE: 0 to 70°C
- DIFFERENTIAL LVDS OUTPUTS
- SURFACE MOUNT PACKAGE
- TAPE AND REEL PACKAGING
- RoHS COMPLIANT / LEAD FREE

### ORDERING INFORMATION

X502 - 622.08M

LVDS  
CLOCK  
SERIES

CENTER  
FREQUENCY

Specifications subject to change without notice.

PRODUCT DATA SHEET

CRYSTAL CONTROLLED OSCILLATORS

**Package Layout**

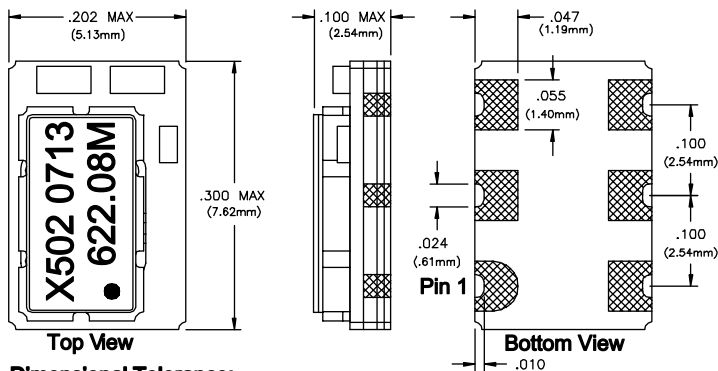

**Dimensional Tolerance:**  
 $\pm .005$  (.127mm)

**Suggested Pad Layout**

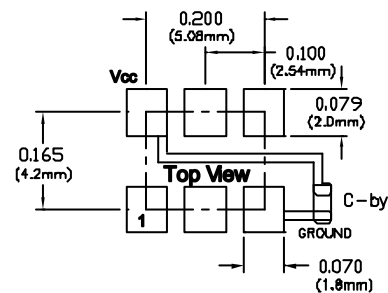

Bypass capacitor, C-by, should be ceramic capacitor  $\geq .01\mu\text{f}$ .

**Output Waveforms**

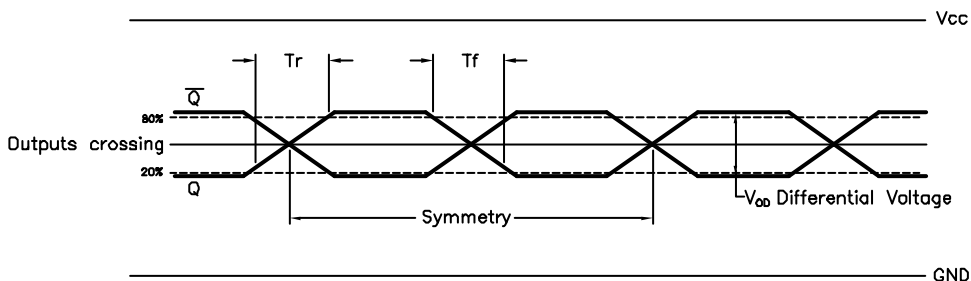

**Pin Connections**

Pin	Function
1	N/C
2	Enable / Disable
3	Ground (Case)
4	Output Q
5	Comp Output Q
6	Vcc

**Test Circuit**

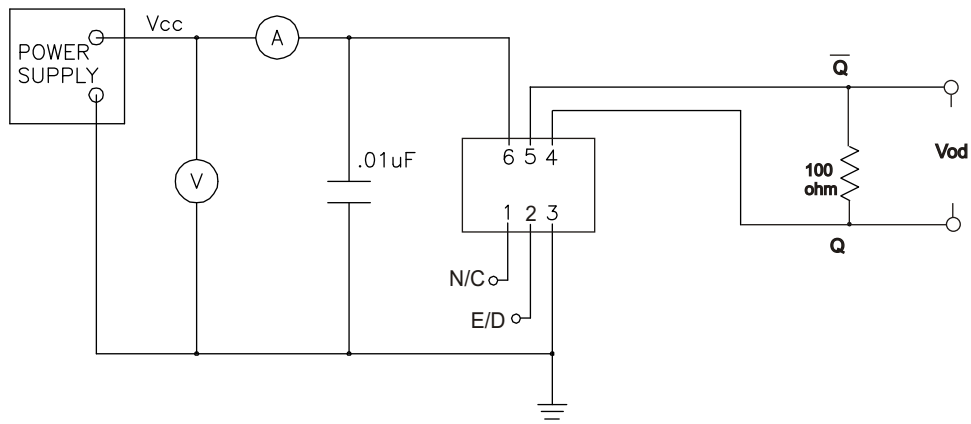

**Solder Profile**

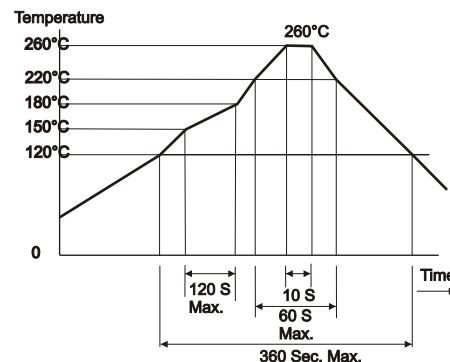

Specifications subject to change without notice.